

Parete 1

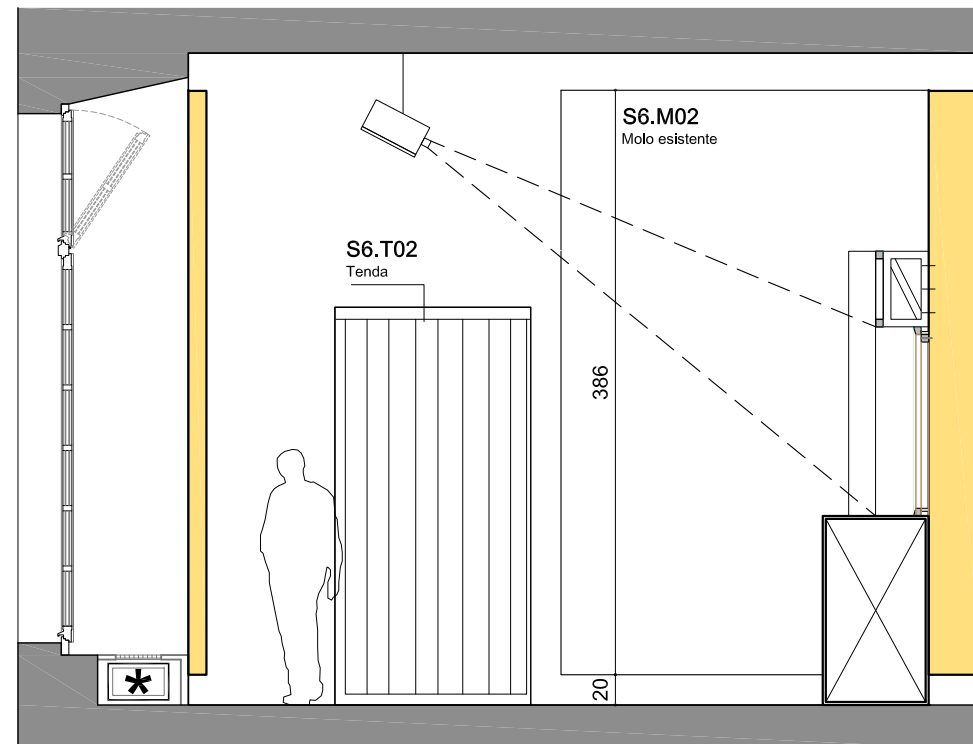

Parete 2

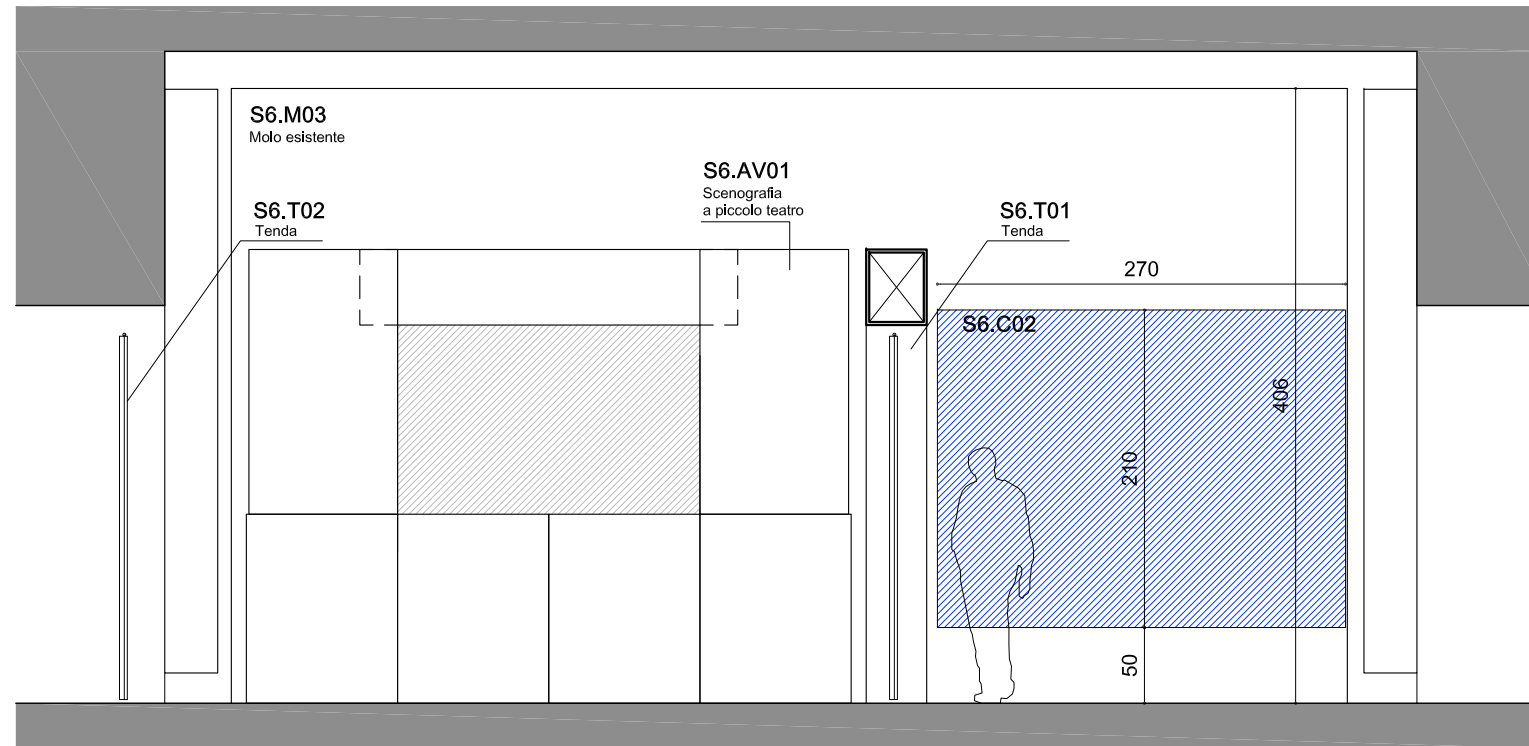

Parete 3

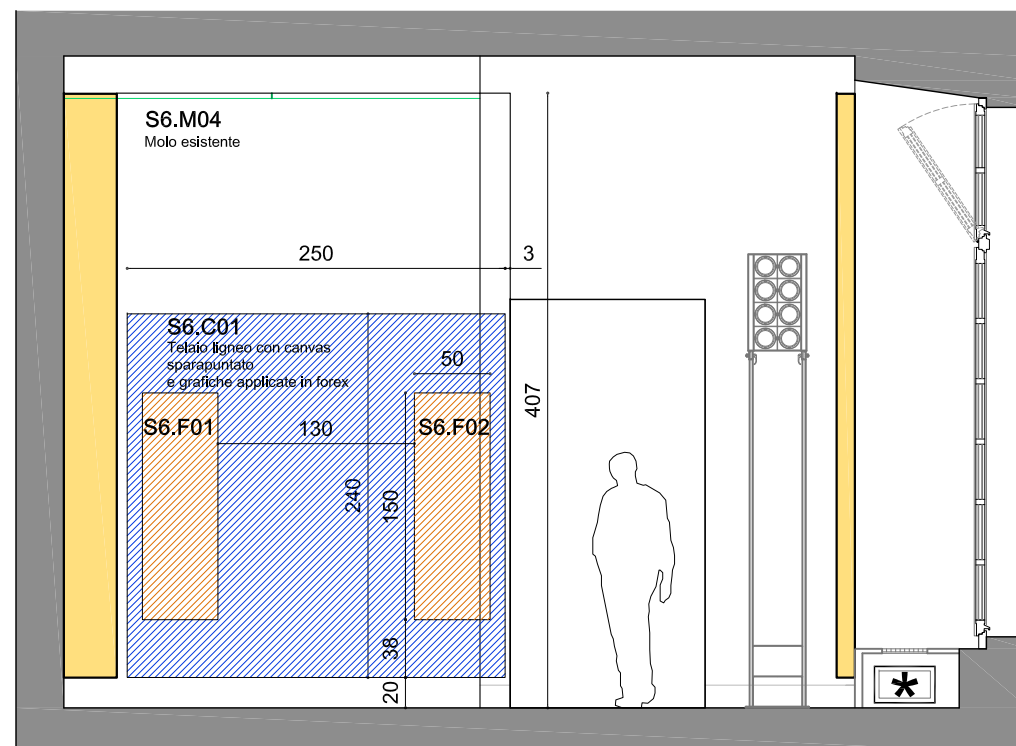

Parete 4

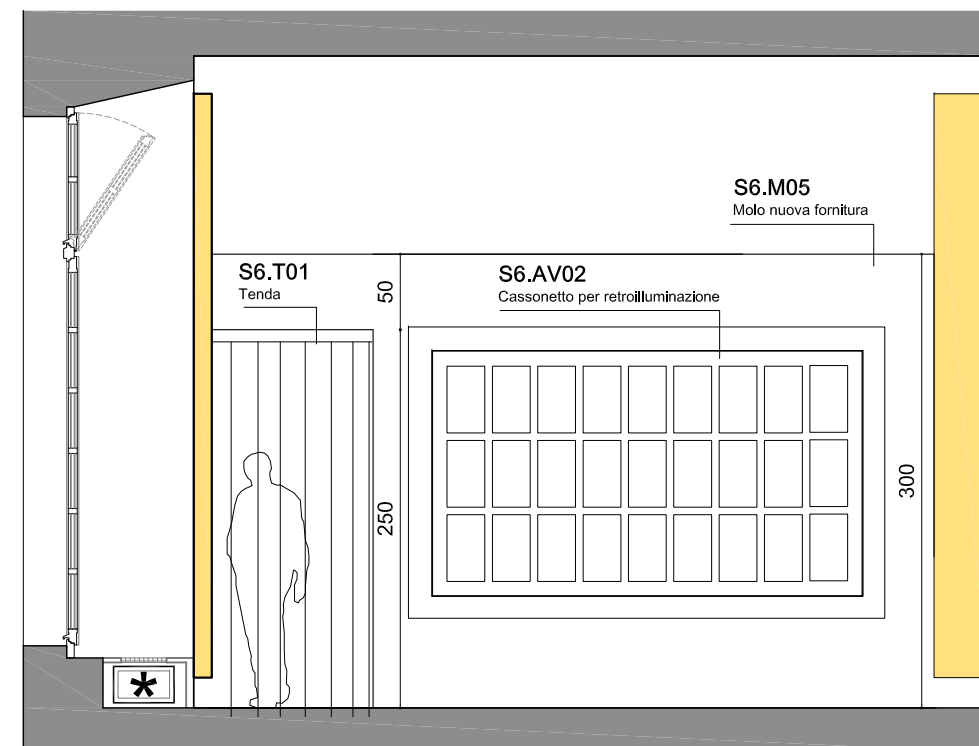

Parete 5

SCHEMA ELEMENTI SCENOGRAFIA

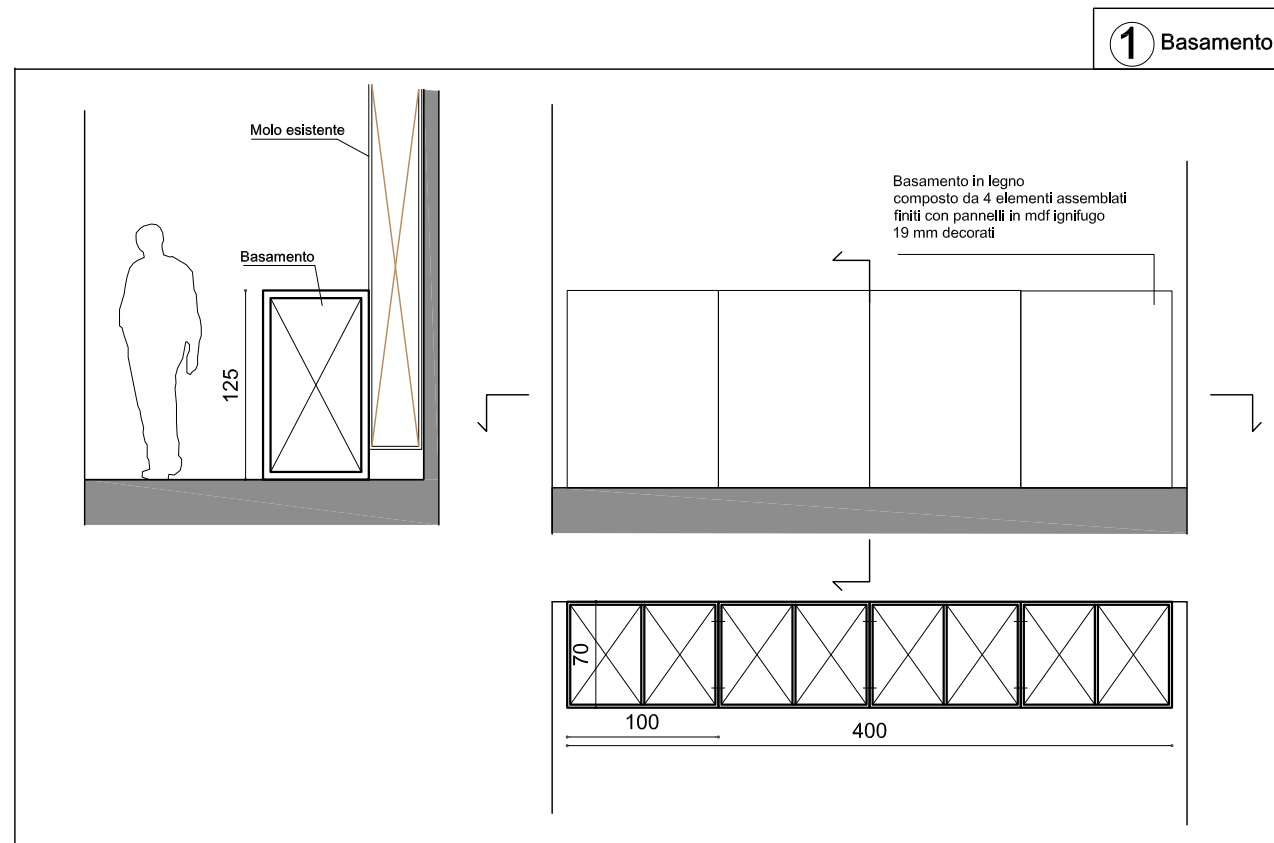
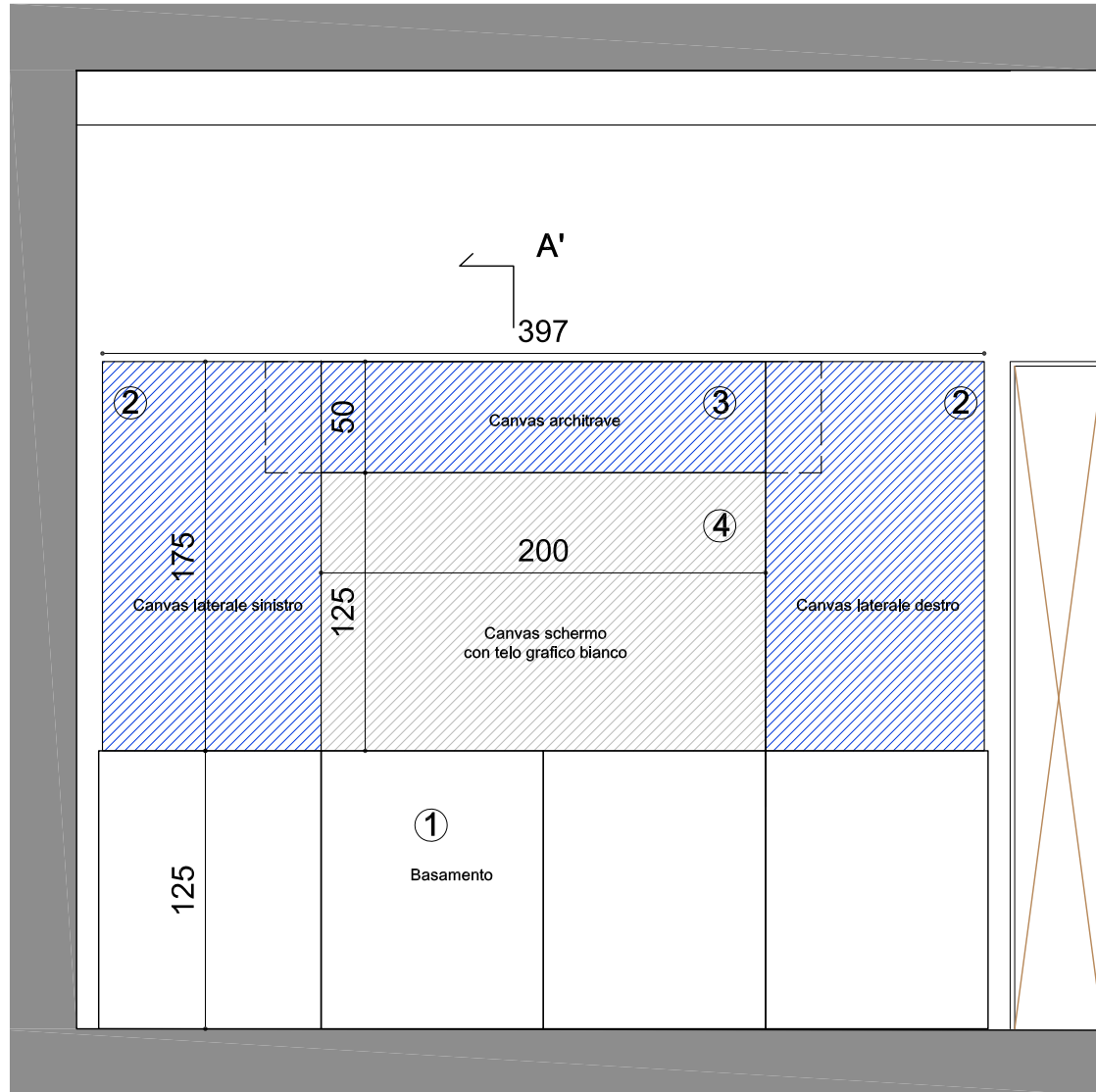

Telaio ligneo realizzato in masselli di legno ignifugato sparapuntato con telo grafico stampato

Per ogni canvas laterale: n° 2 cavalle in legno massello ignifugato

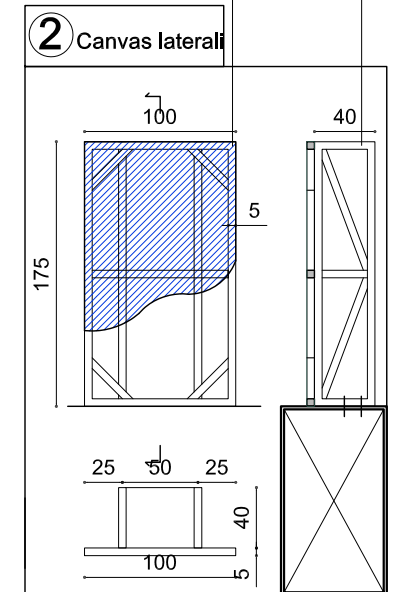

N.B. TUTTI I CANVAS SONO DI TIPO IGNIFUGO

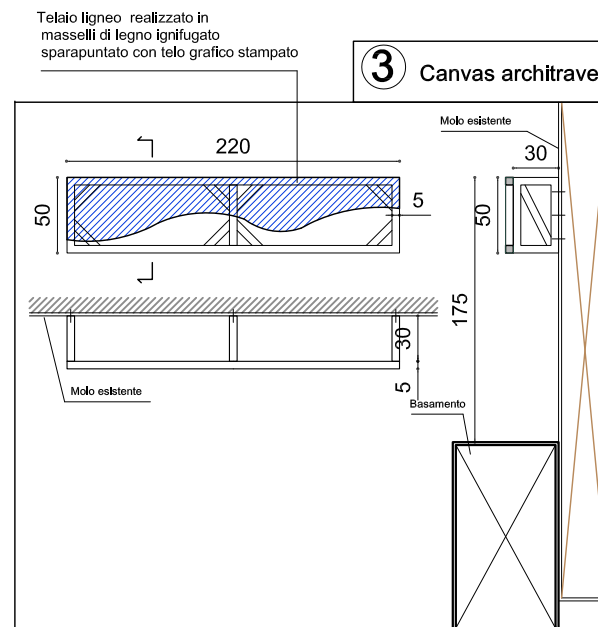

Telaio ligneo realizzato in masselli di legno ignifugato sparapuntato con telo grafico bianco per proiezione.

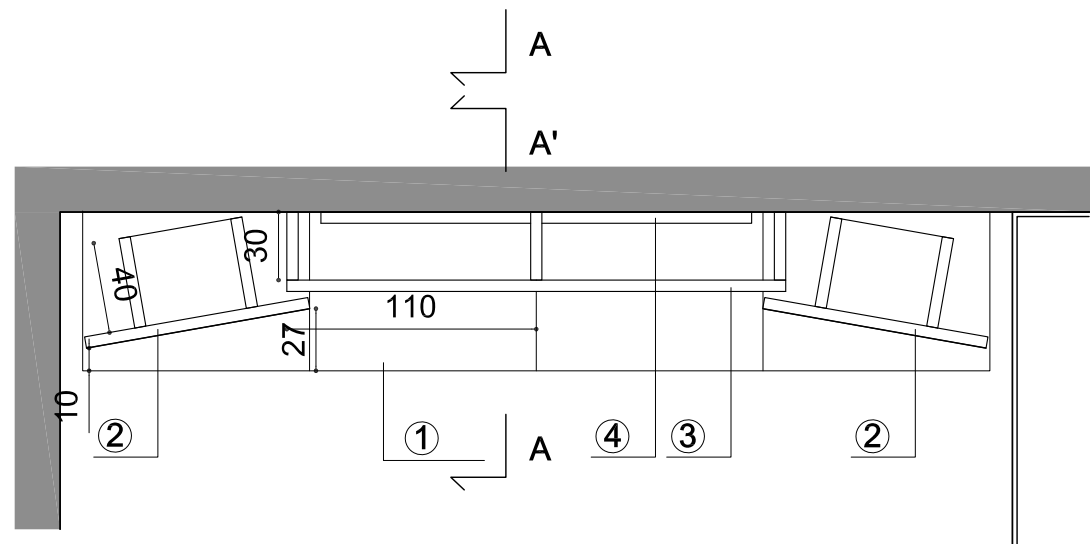
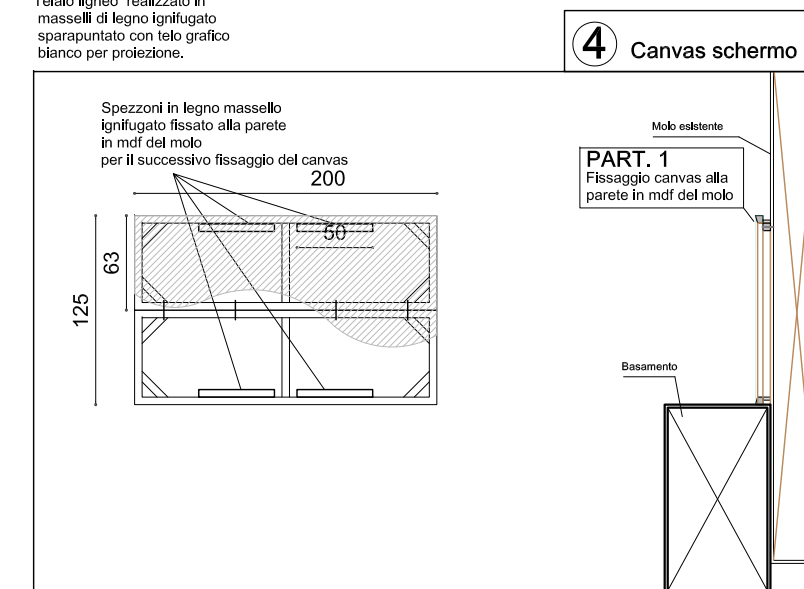

PART. 1 Fissaggio canvas alla parete in mdf del molo

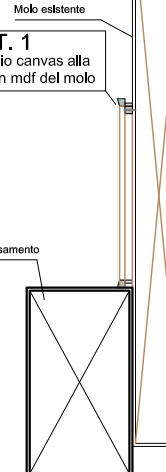

S6.AV01
Scenografia a piccolo "teatro"

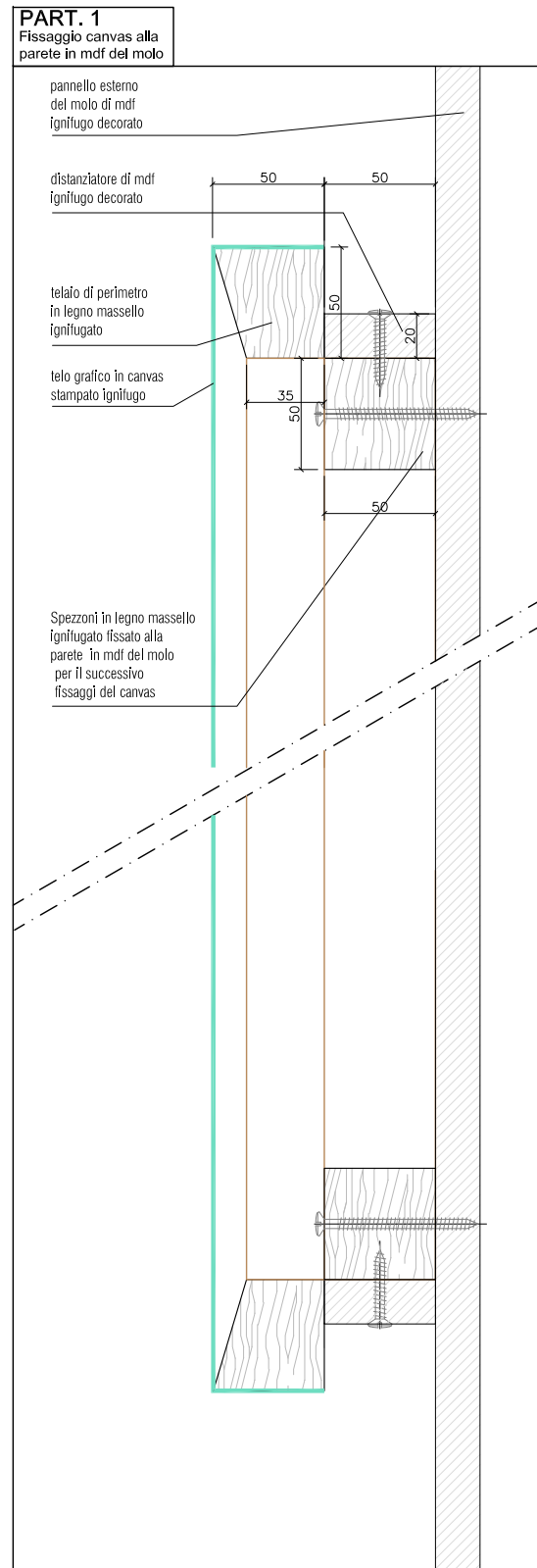
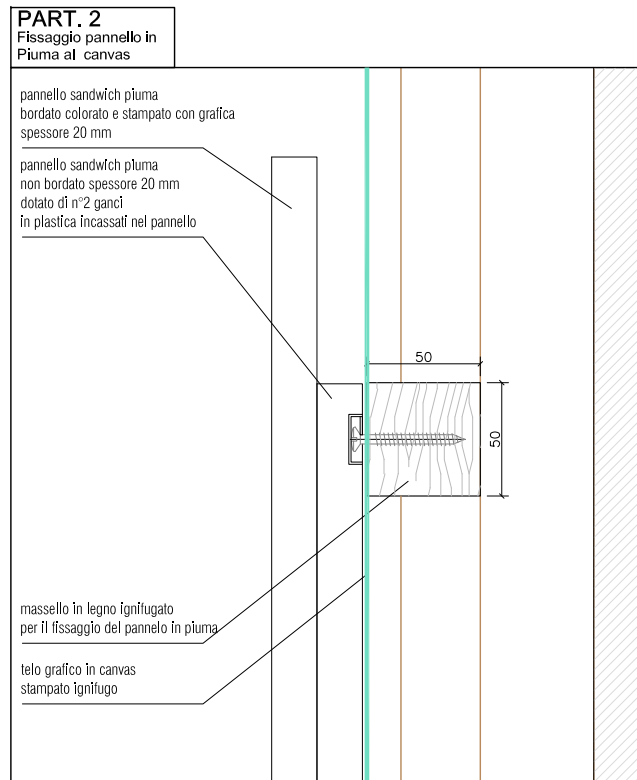

S6.C01
Telaio ligneo sparapuntato con telo grafico realizzato in masselli di legno ignifugato

S6.F01/F02
Doppio pannello in piuma spessore 20 mm

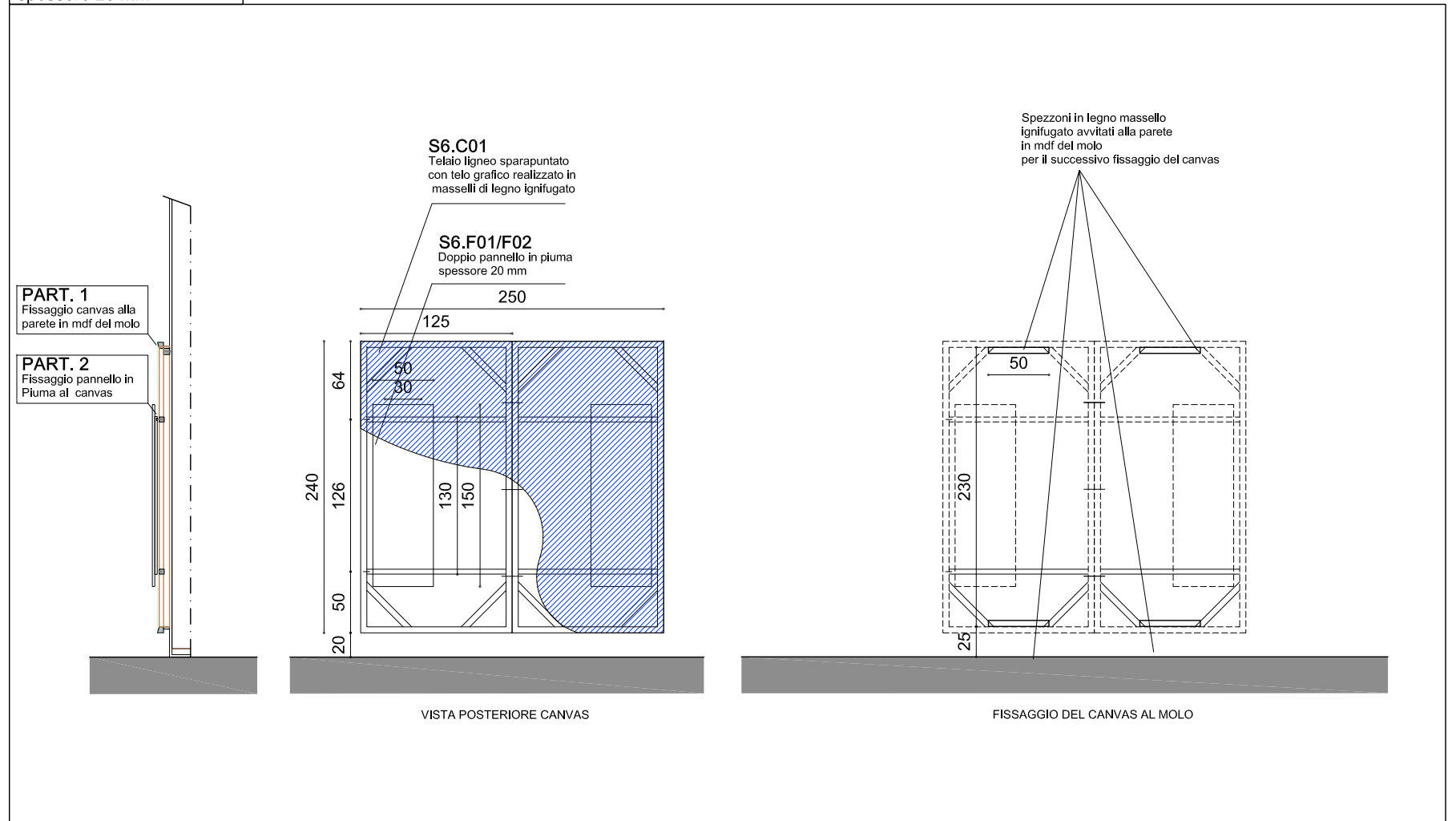

S6.AV02
Parete retroilluminata

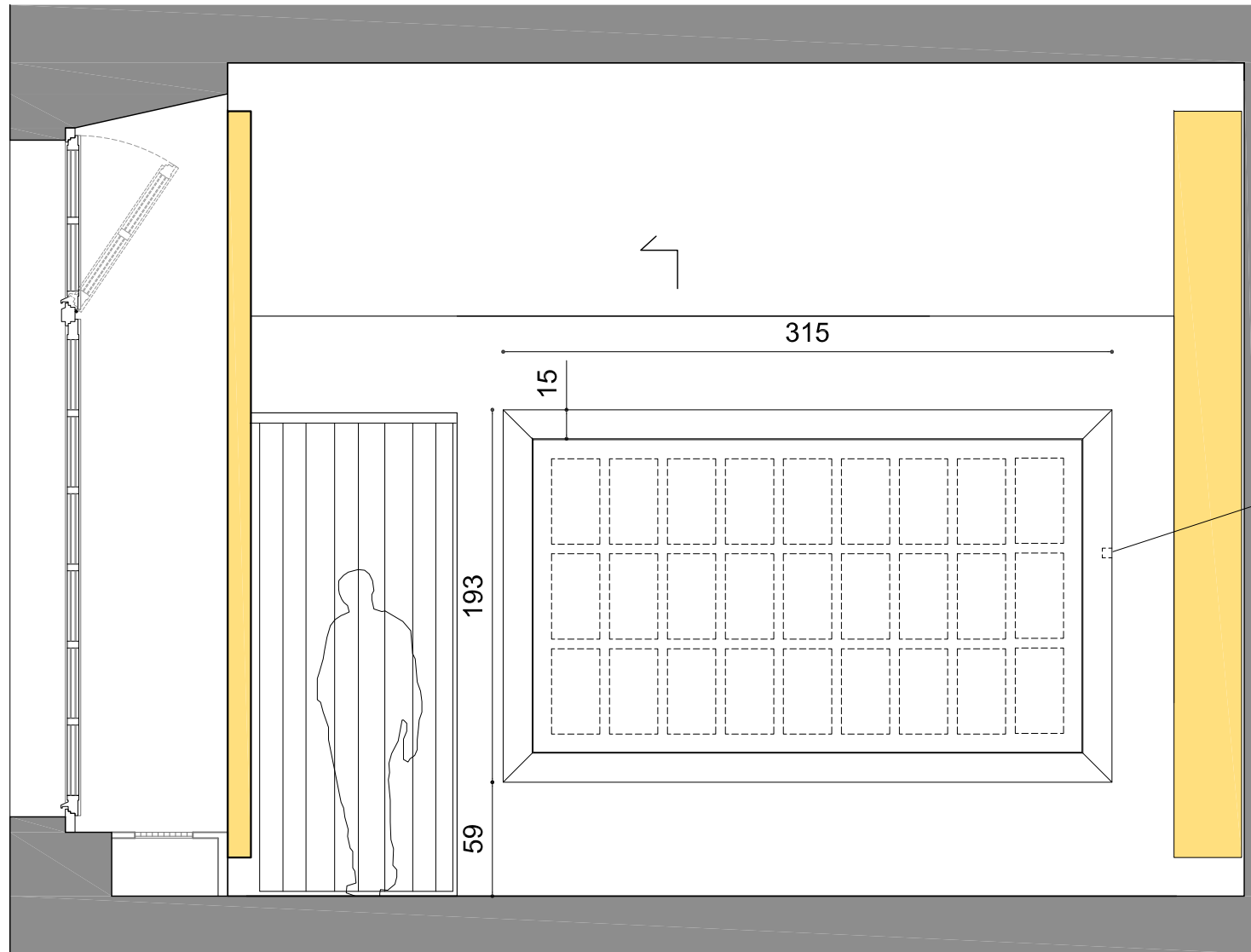

PART. 3
Cornice parete retroilluminata

Interruttore nascosto per accensione strisce led

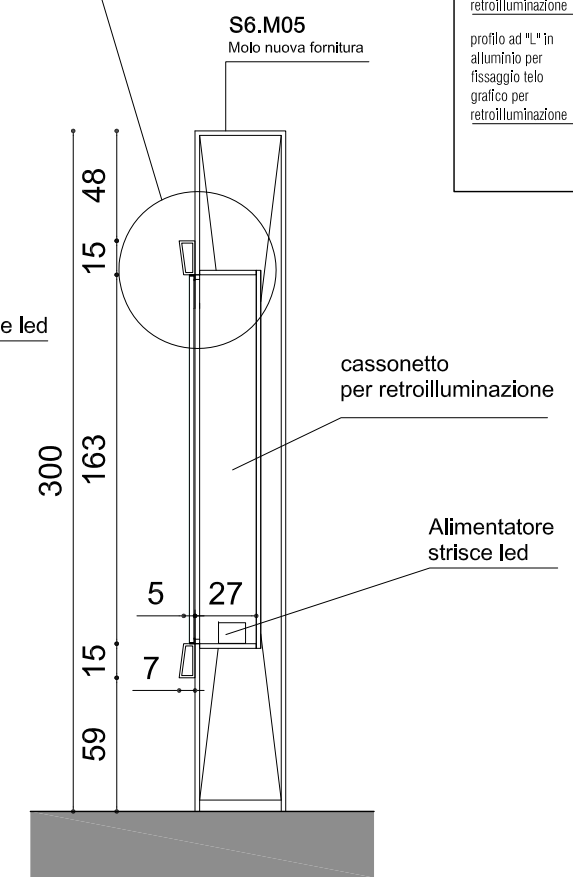

SEZIONE

PART. 1
Cornice parete retroilluminata

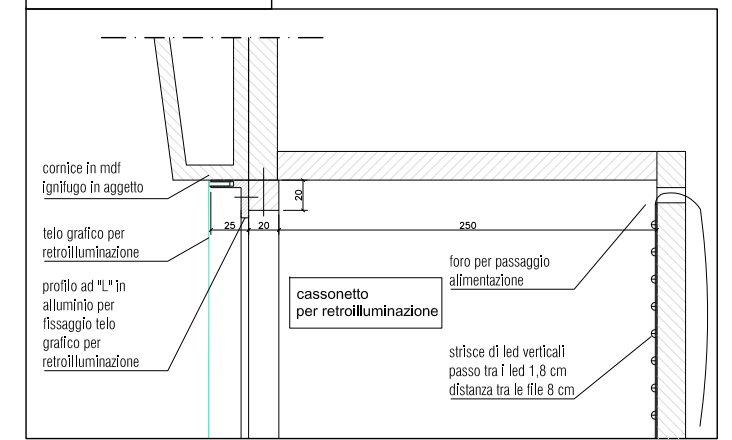

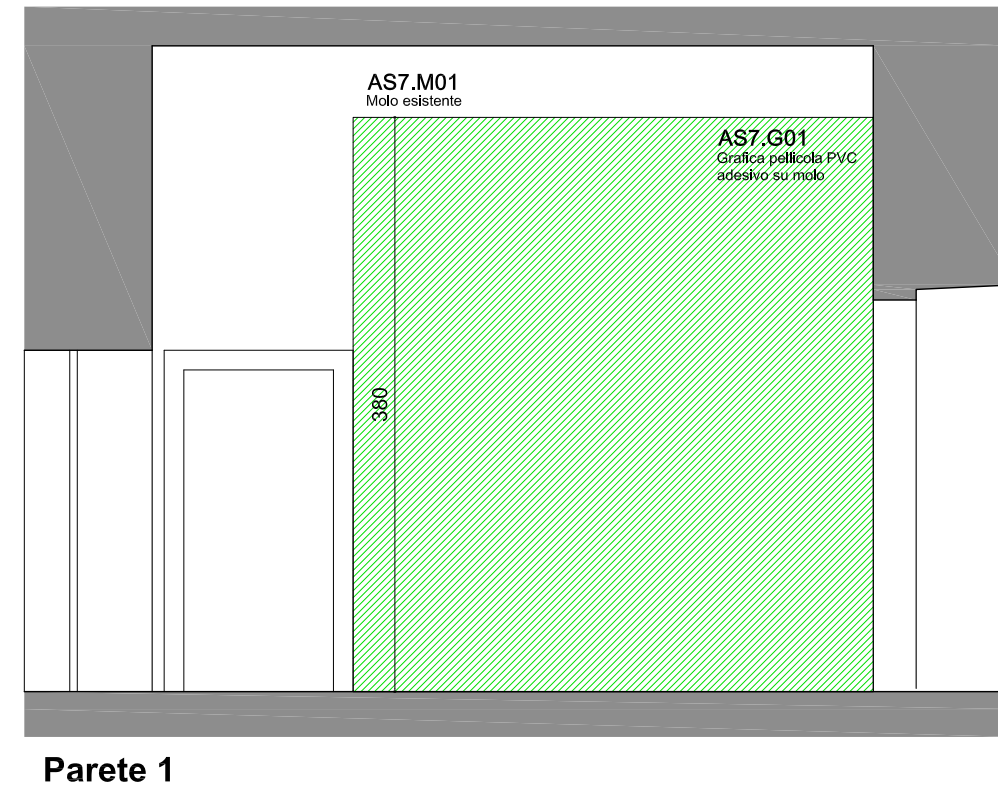
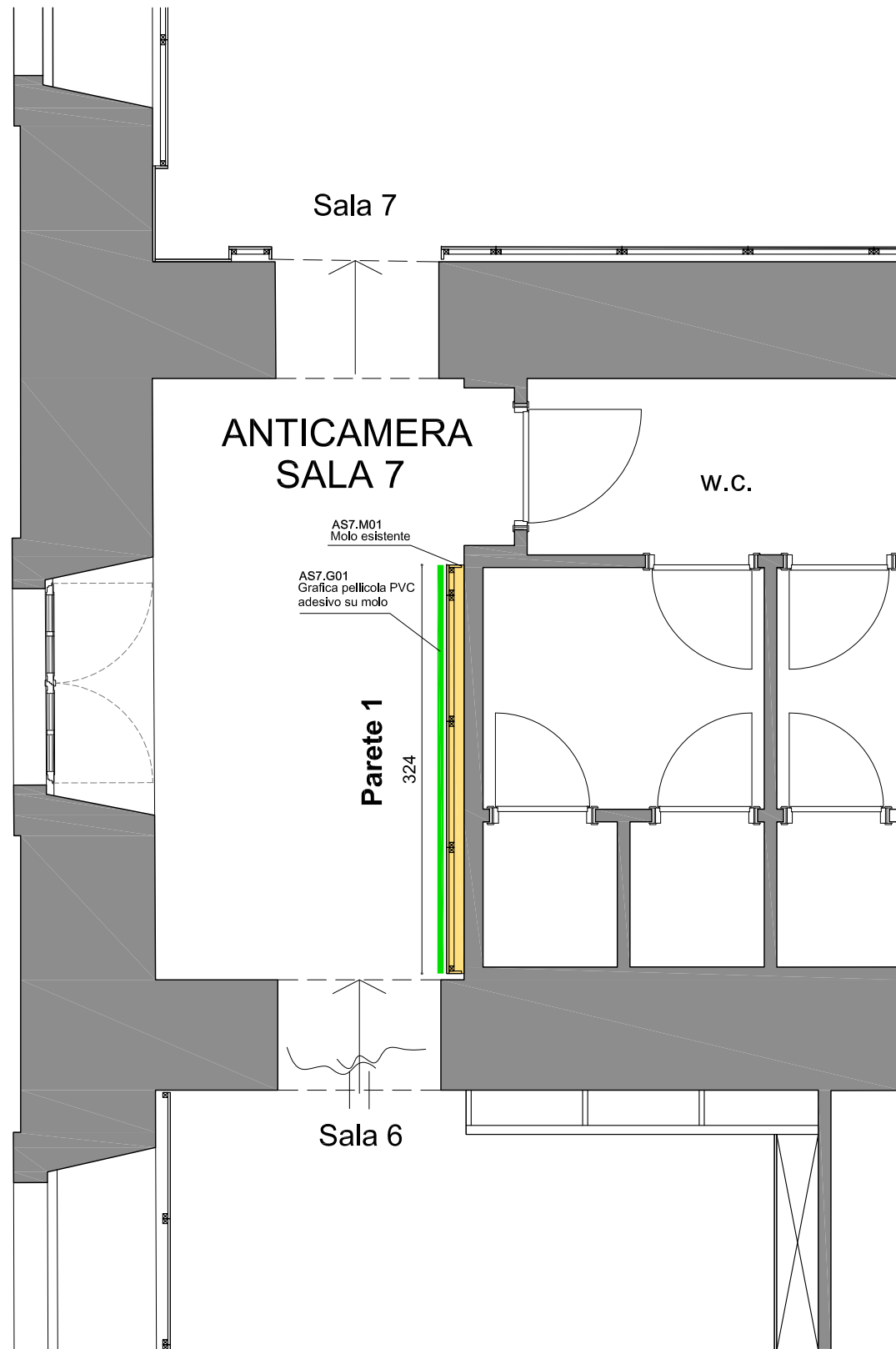

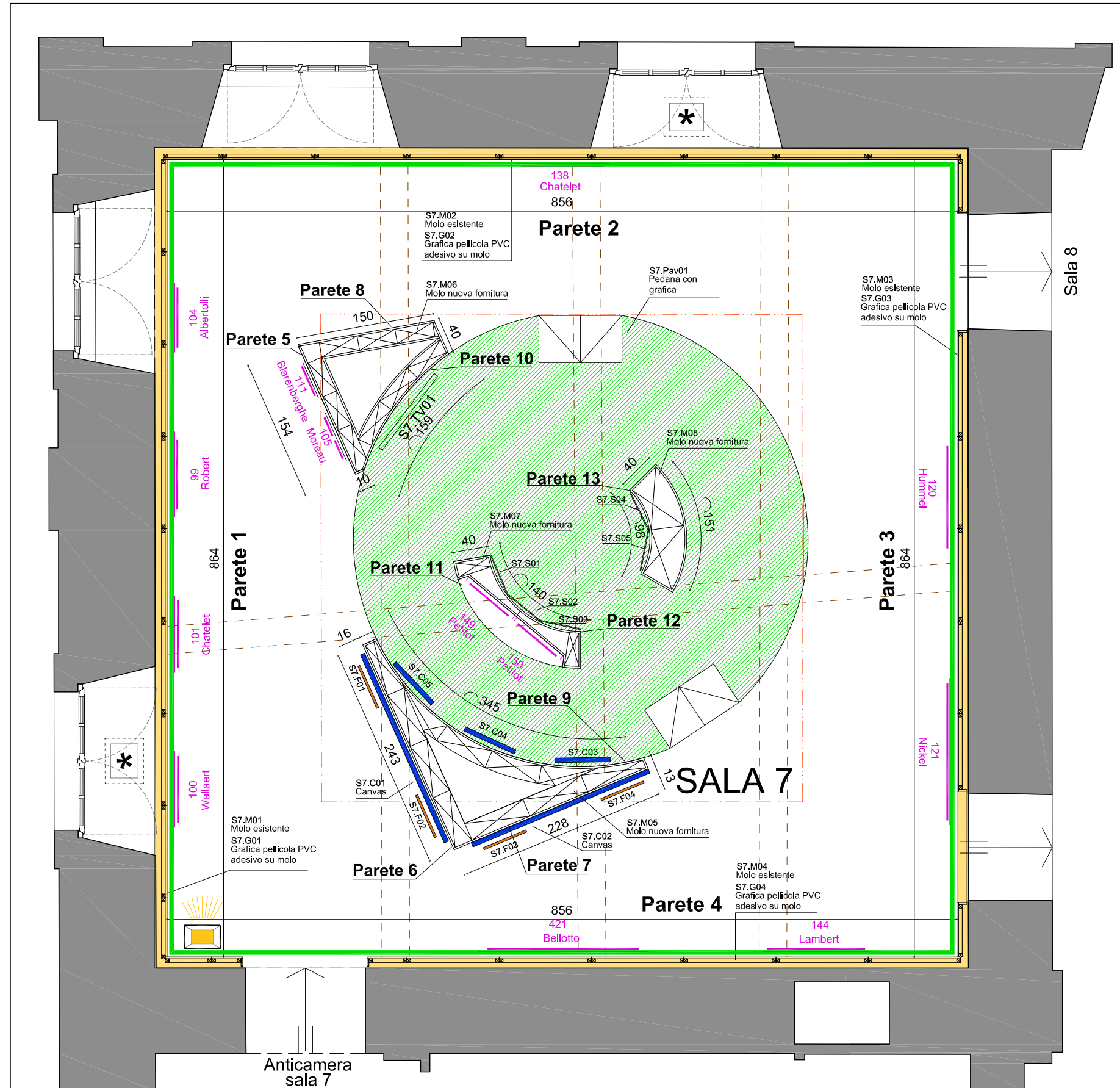

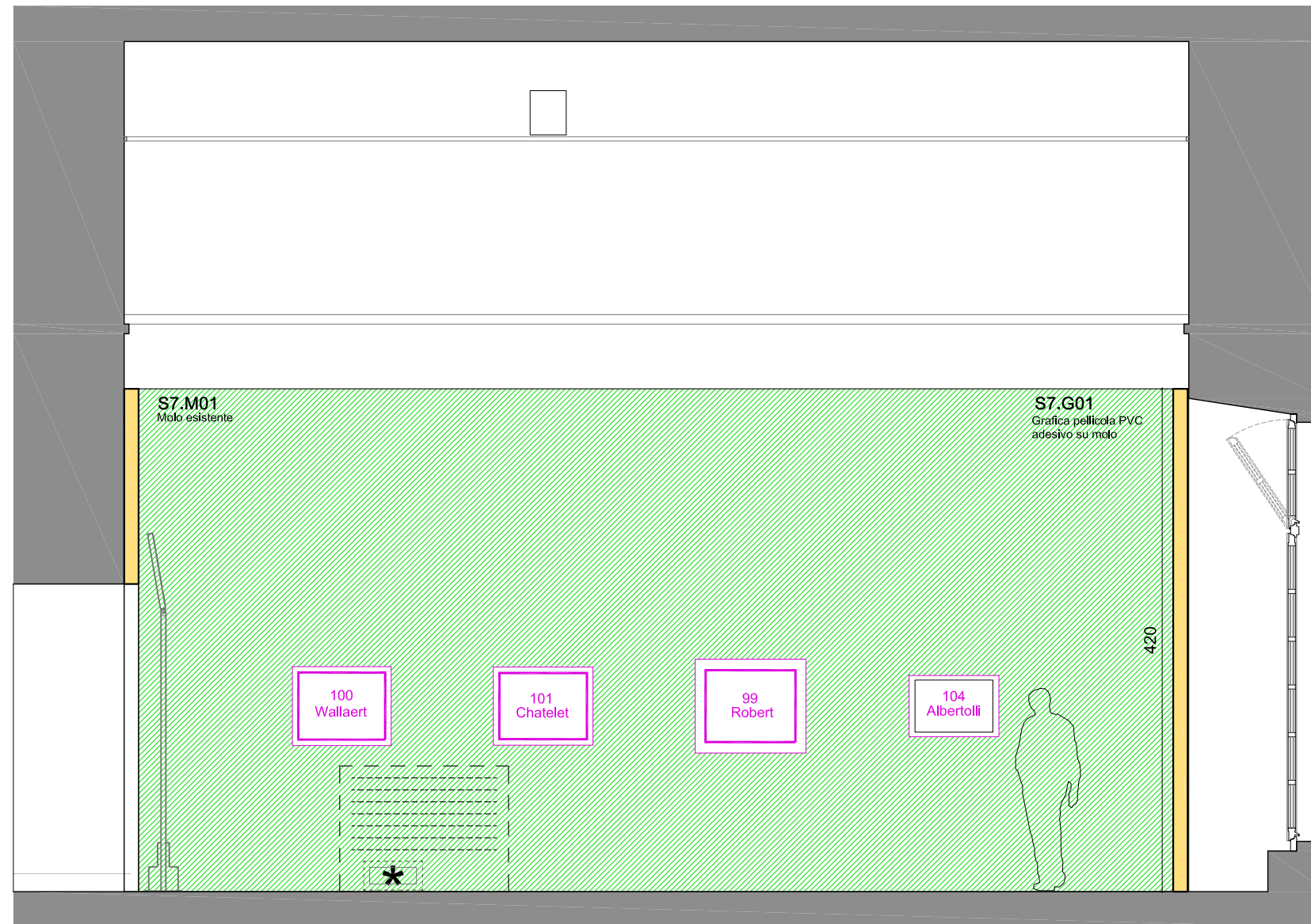

Parete 1

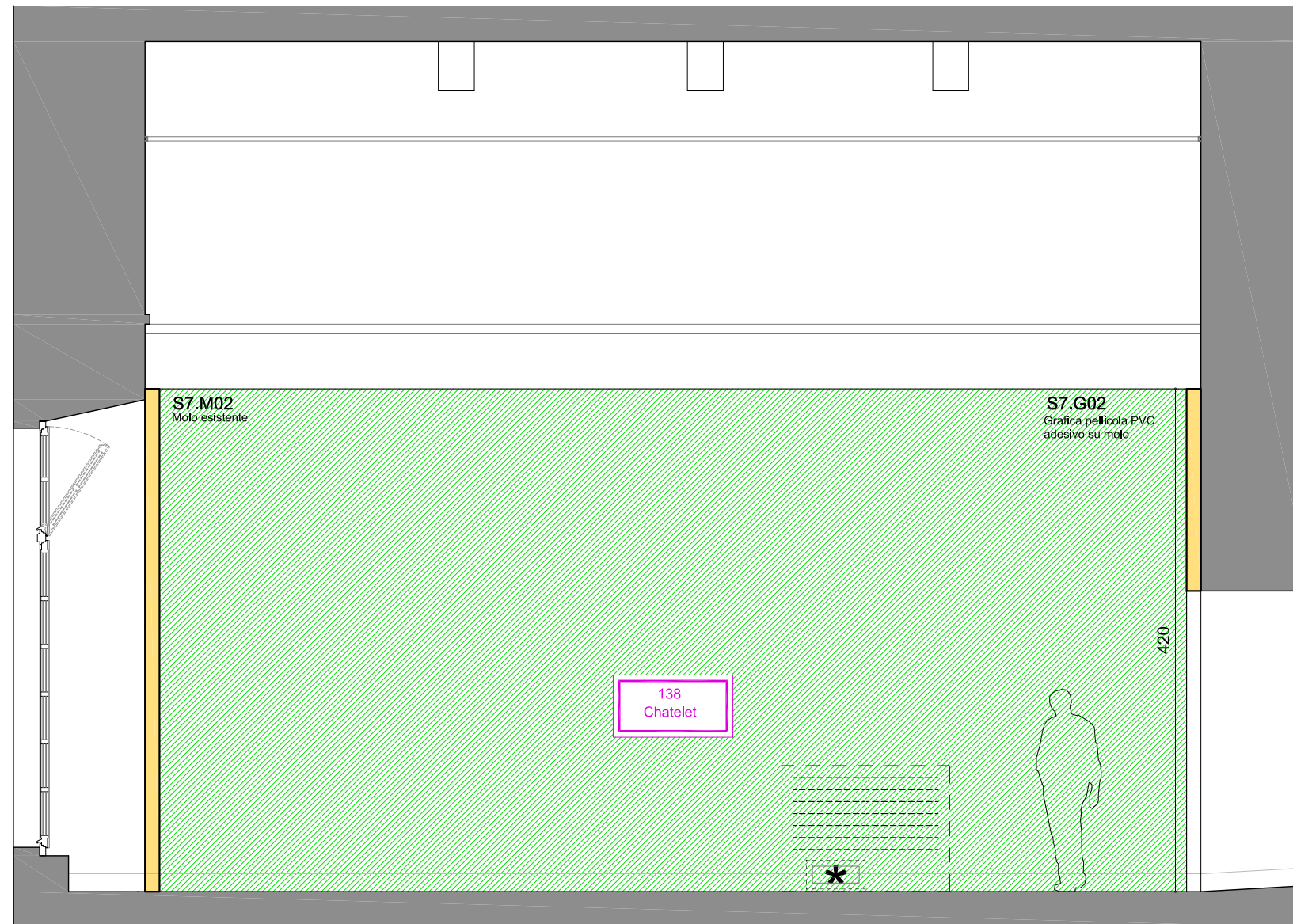

Parete 2

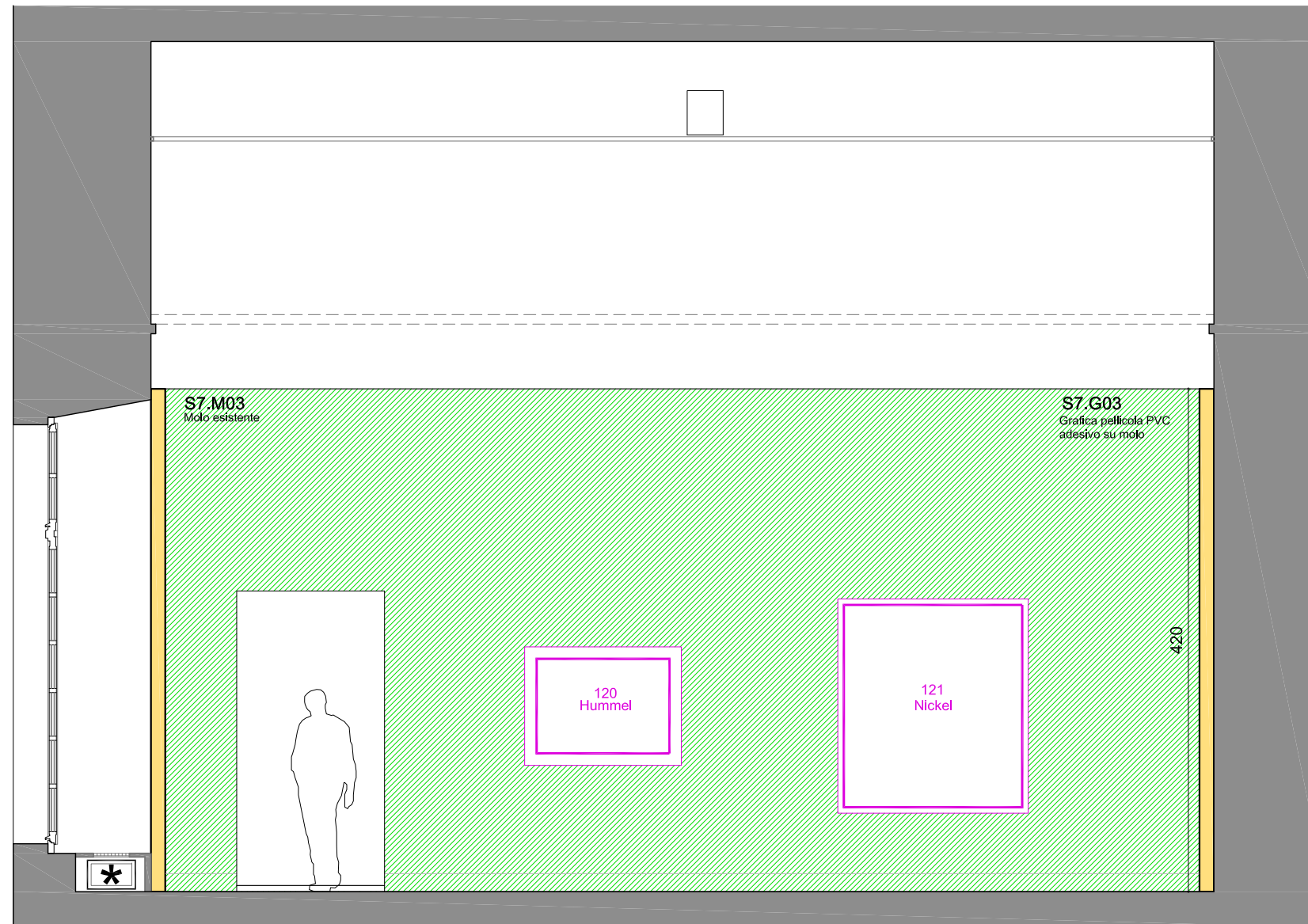

Parete 3

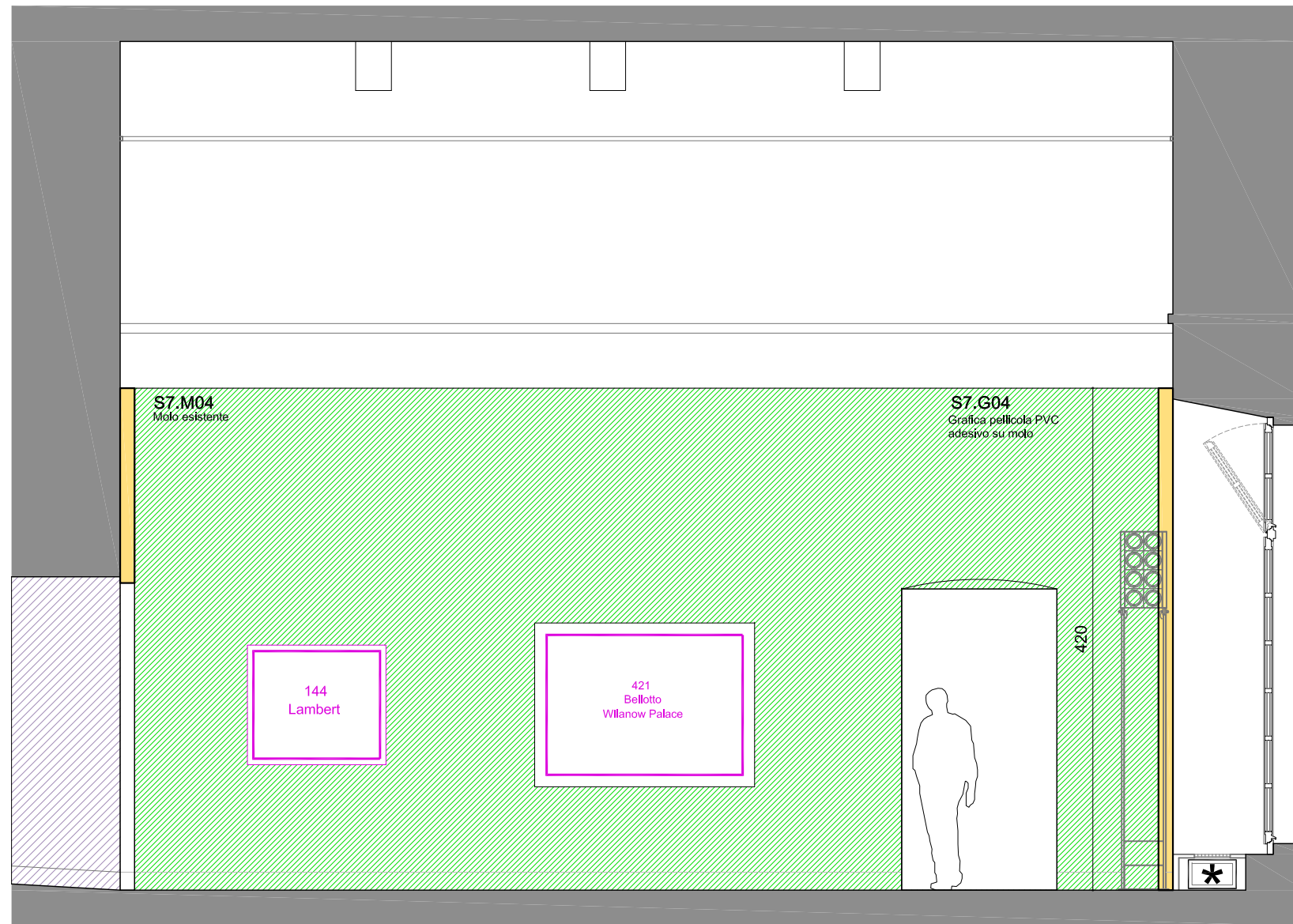

Parete 4

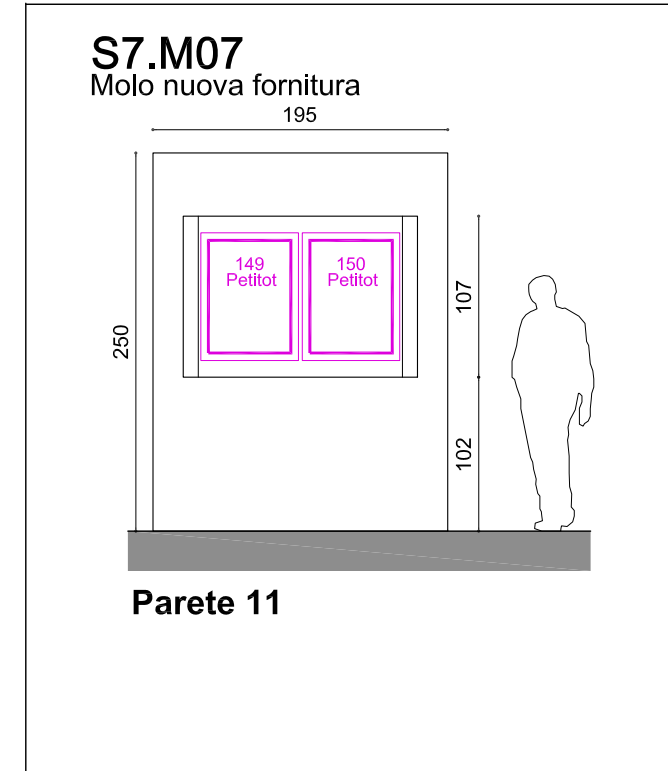
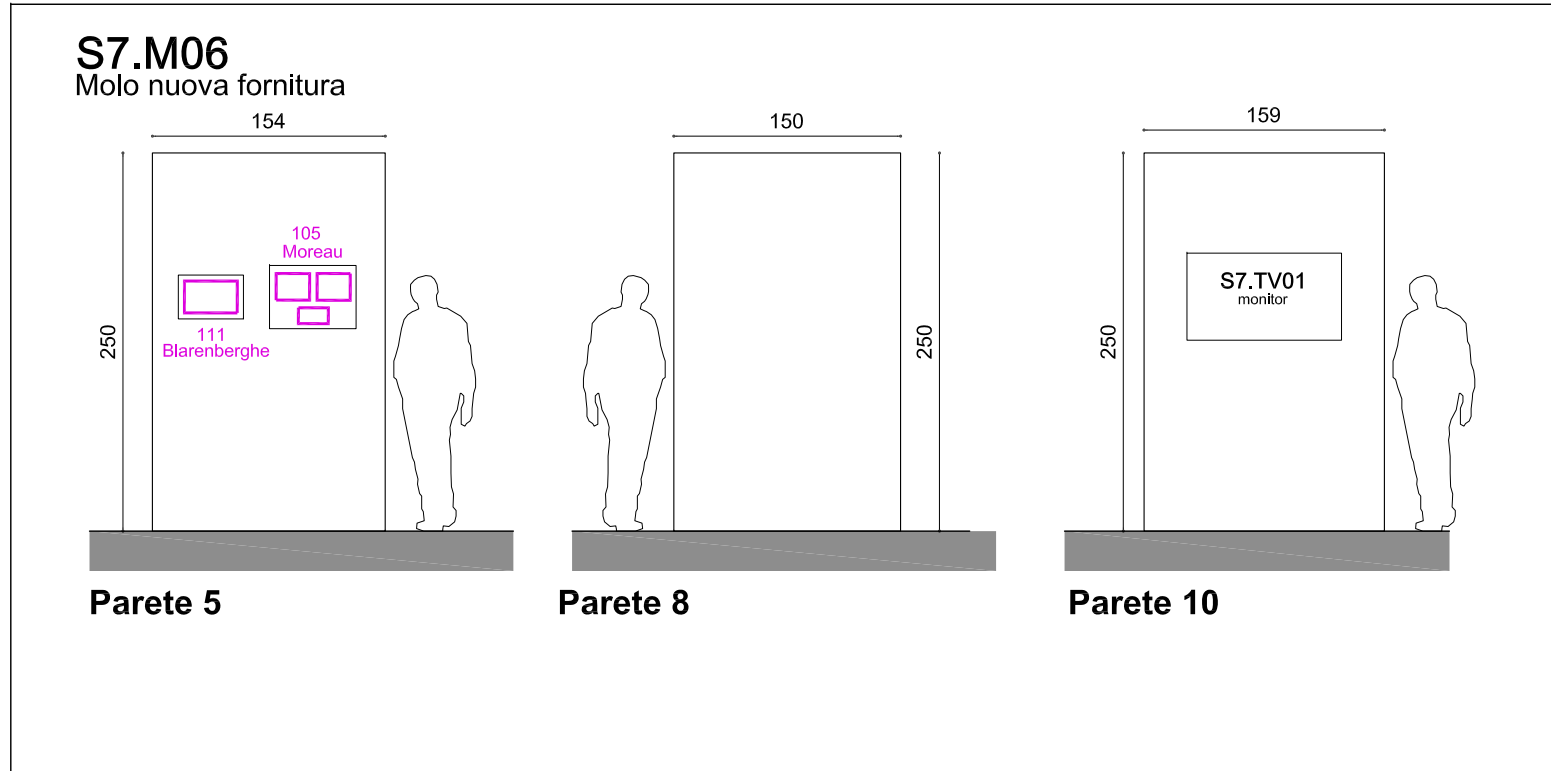
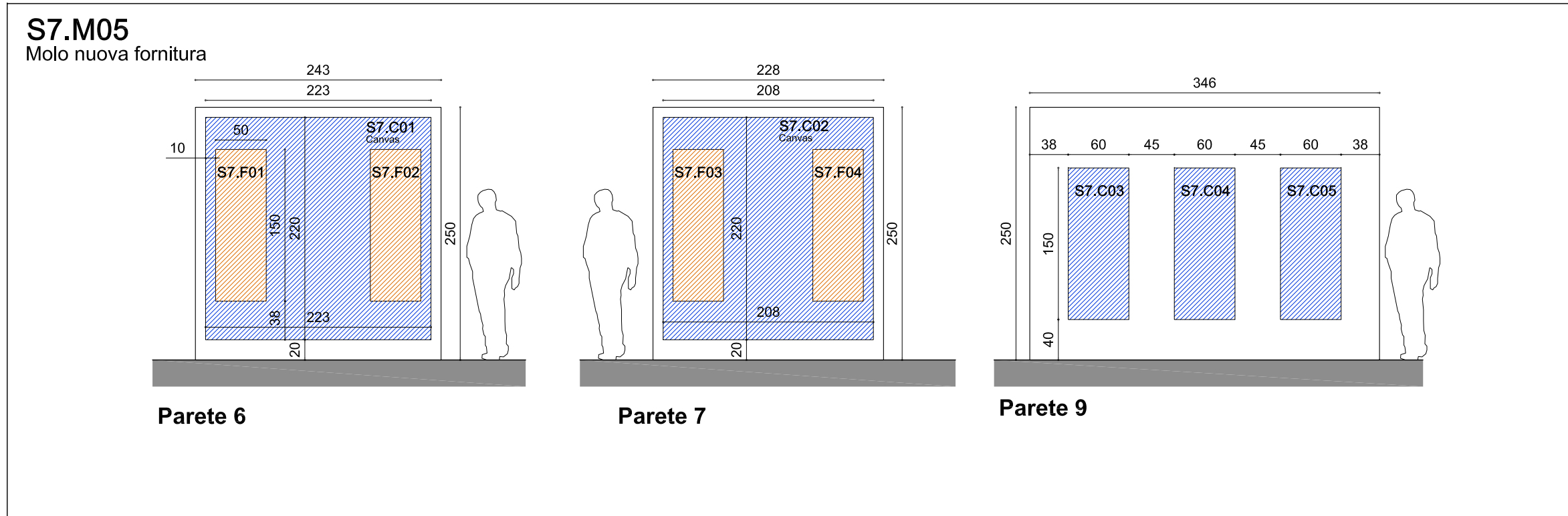

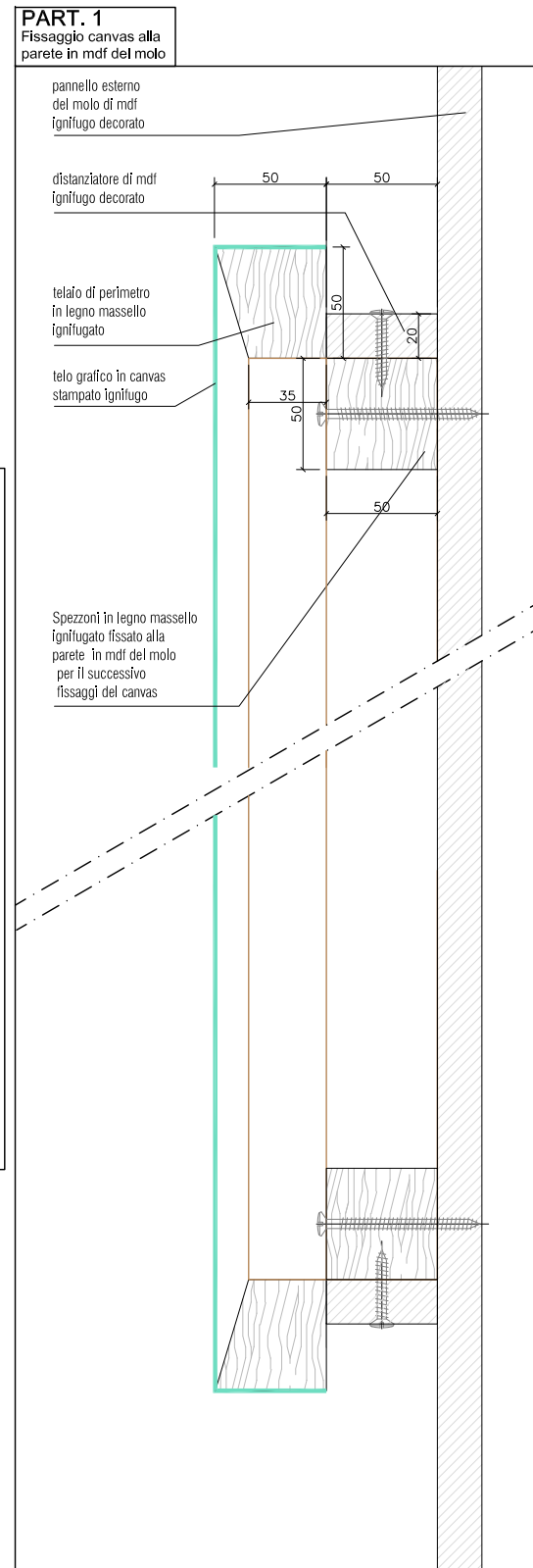
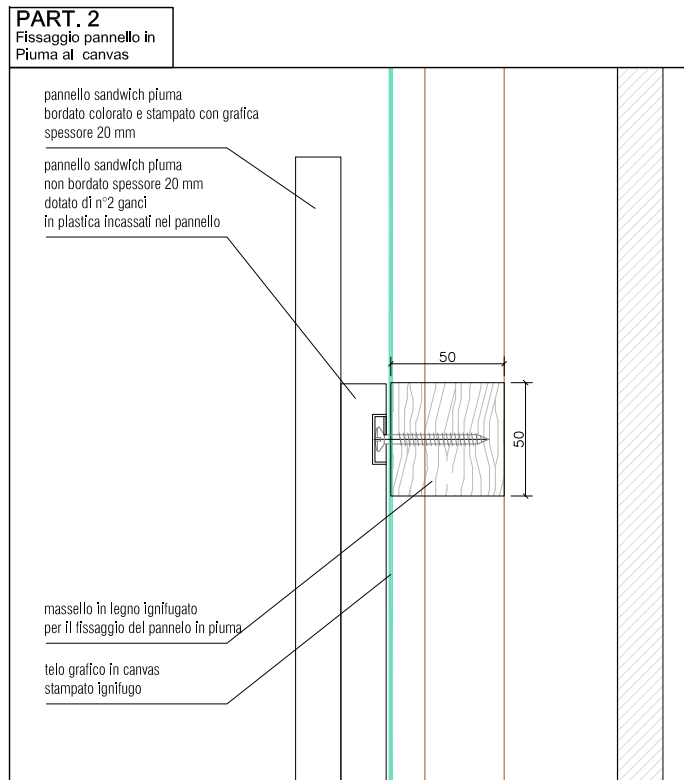

S7.C01
Telaio ligneo sparapuntato con telo grafico realizzato in masselli di legno ignifugato

S7.F01/F02
Doppio pannello in piuma spessore 20 mm

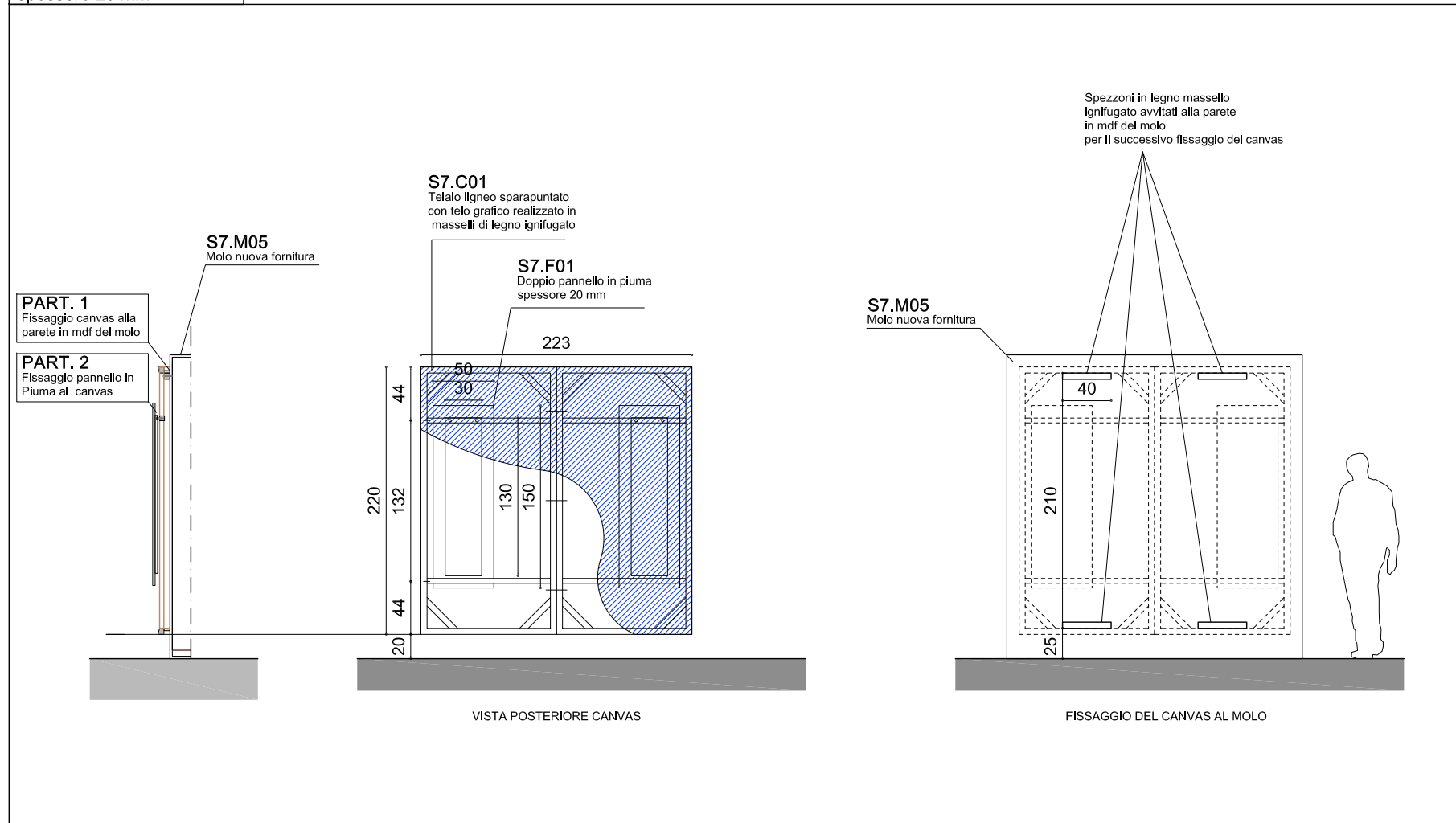

PART. 2
Fissaggio pannello in Piuma al canvas

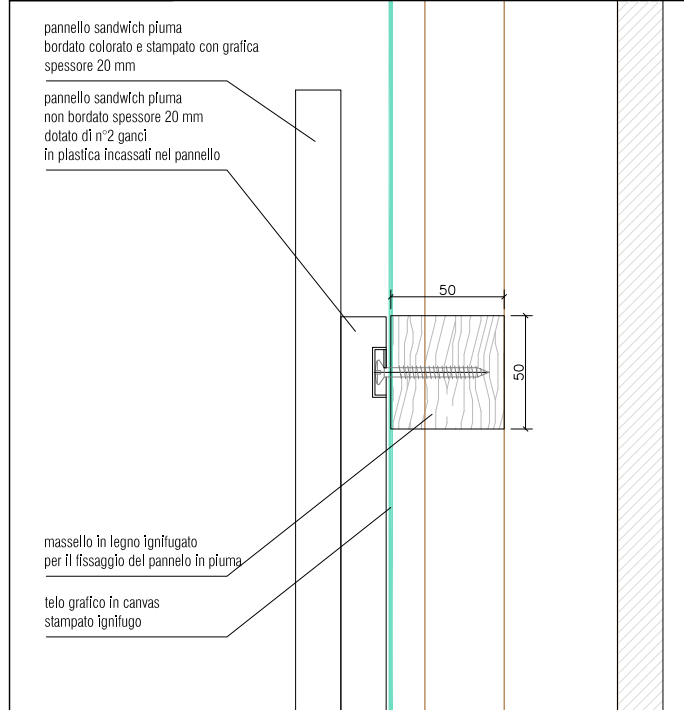

PART. 1
Fissaggio canvas alla parete in mdf del molo

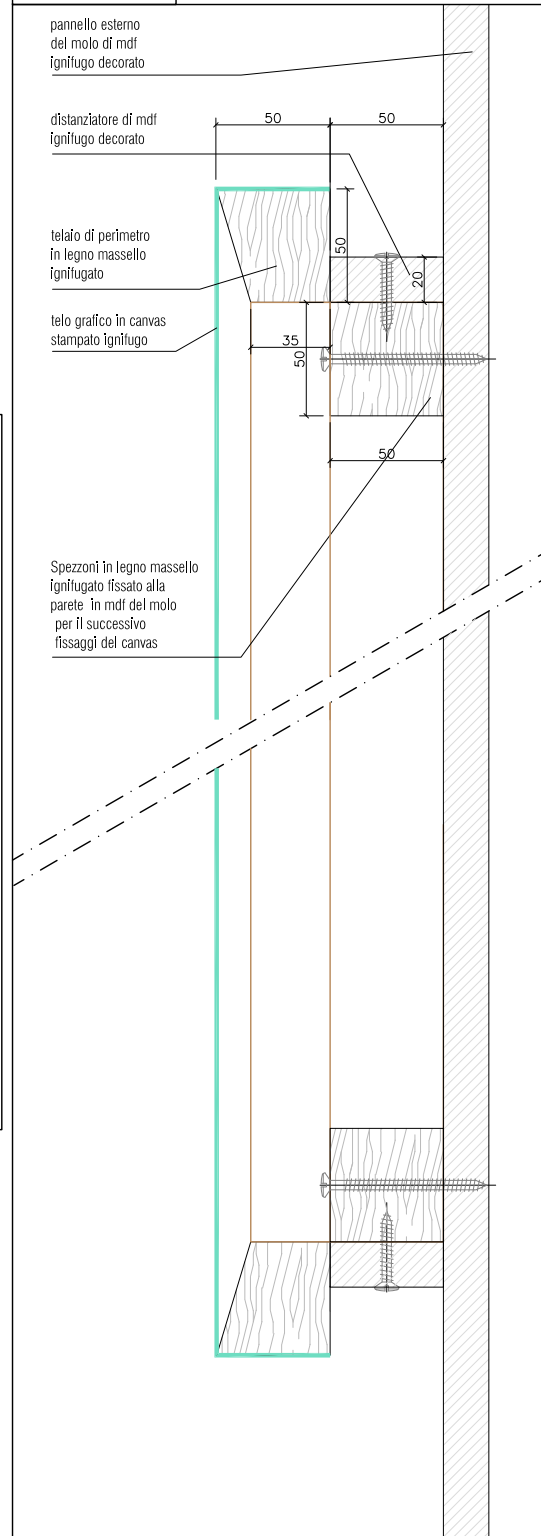

S7.C02
Telaio ligneo sparapuntato con telo grafico realizzato in masselli di legno ignifugato

S7.F03/F04
Doppio pannello in piuma spessore 20 mm

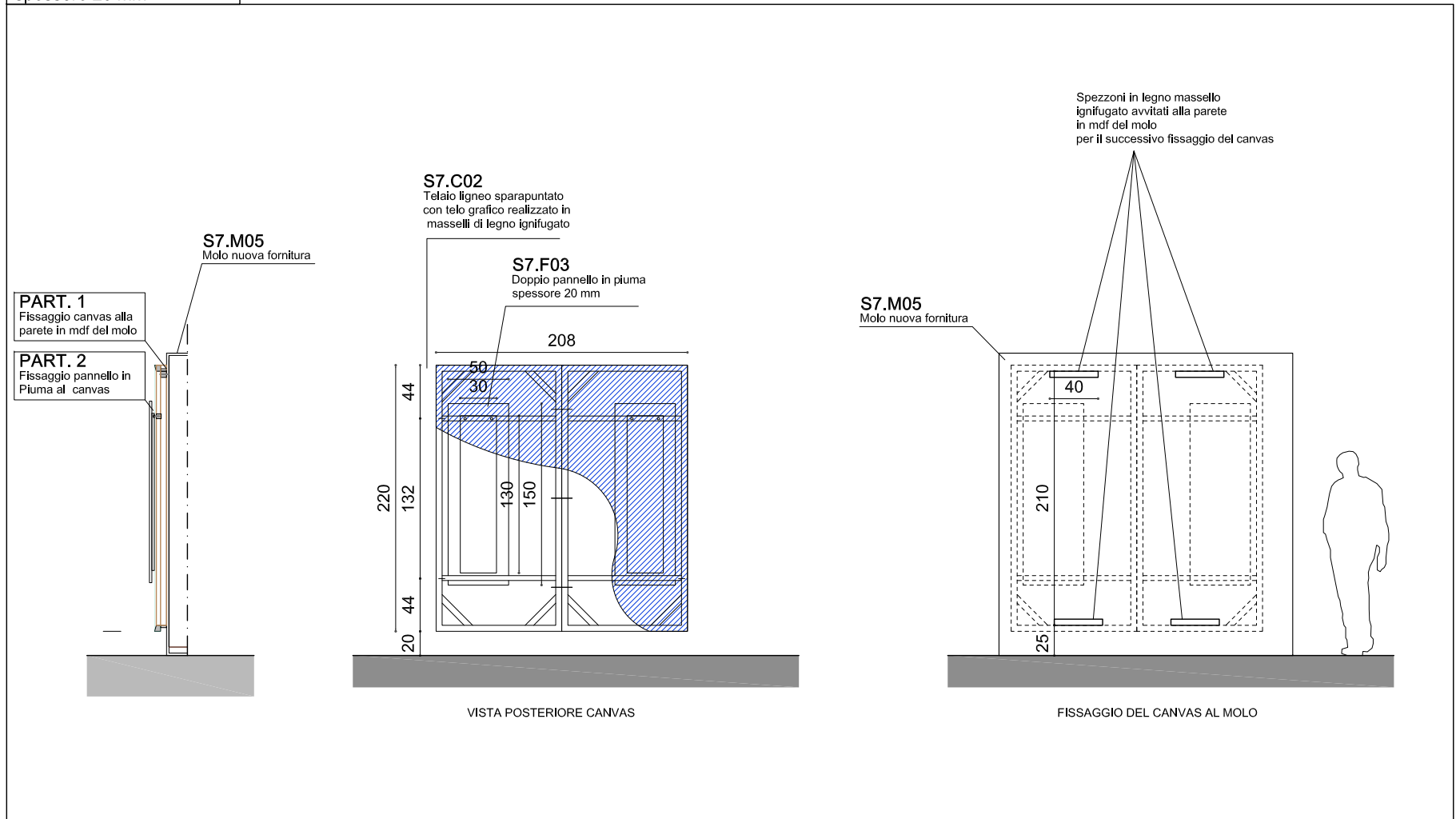

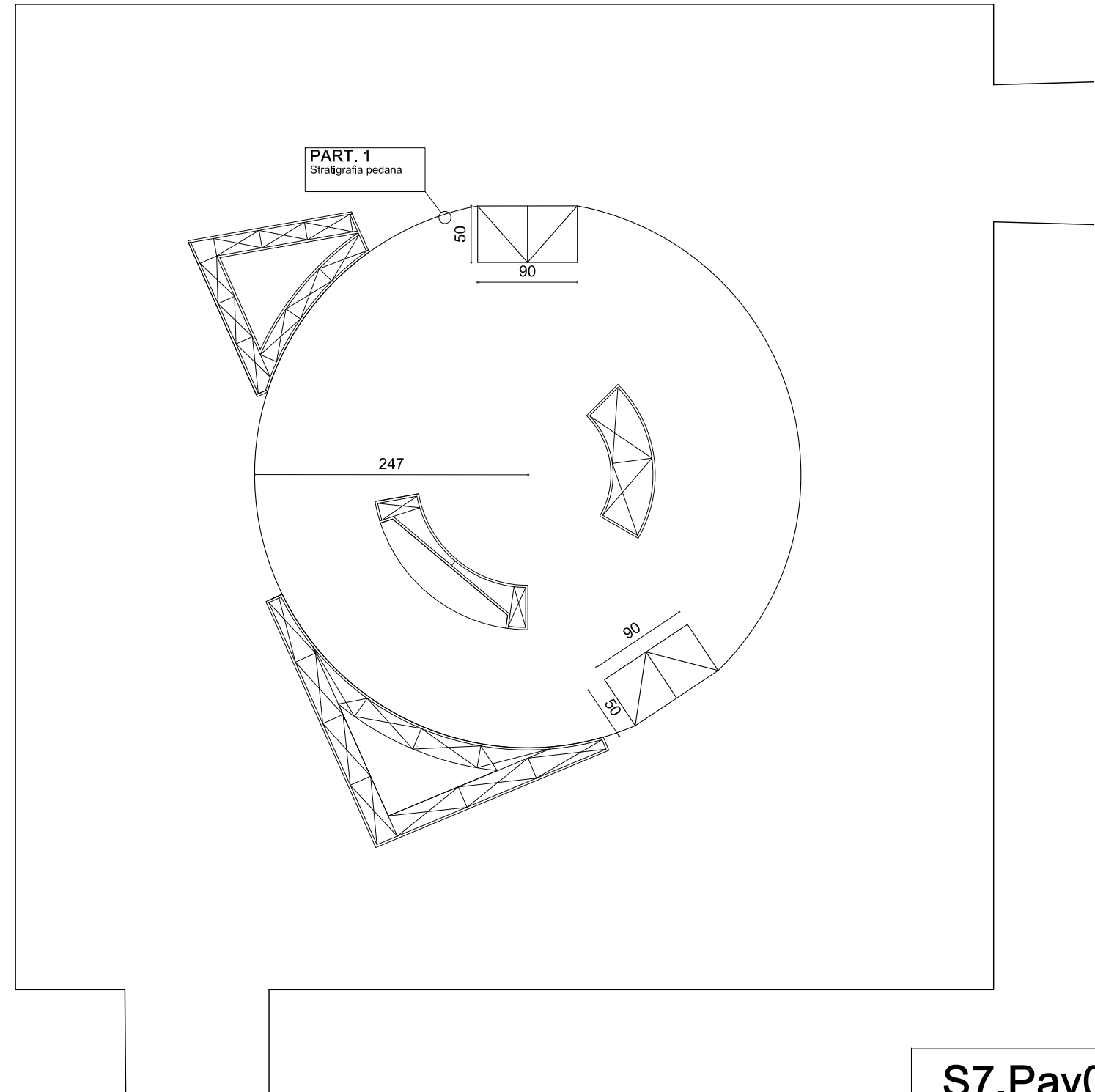
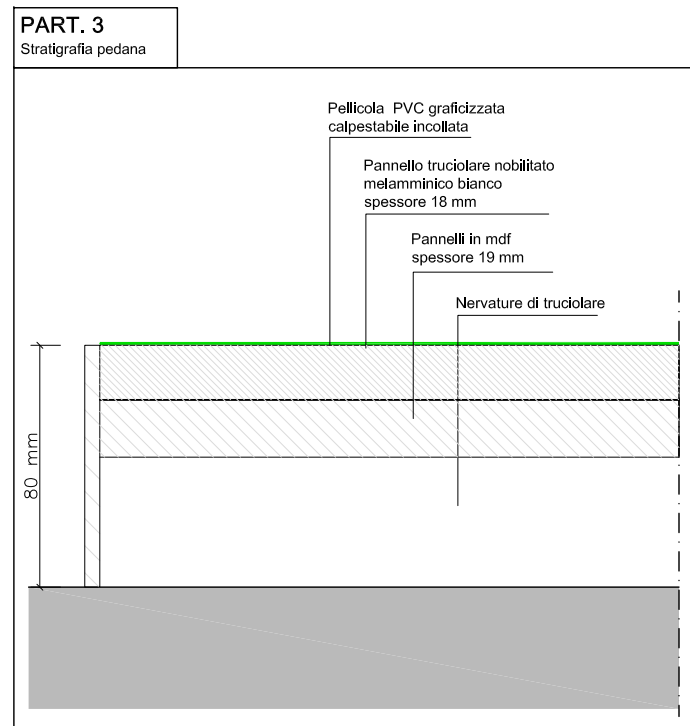

S7.Pav01
Pedana con grafica

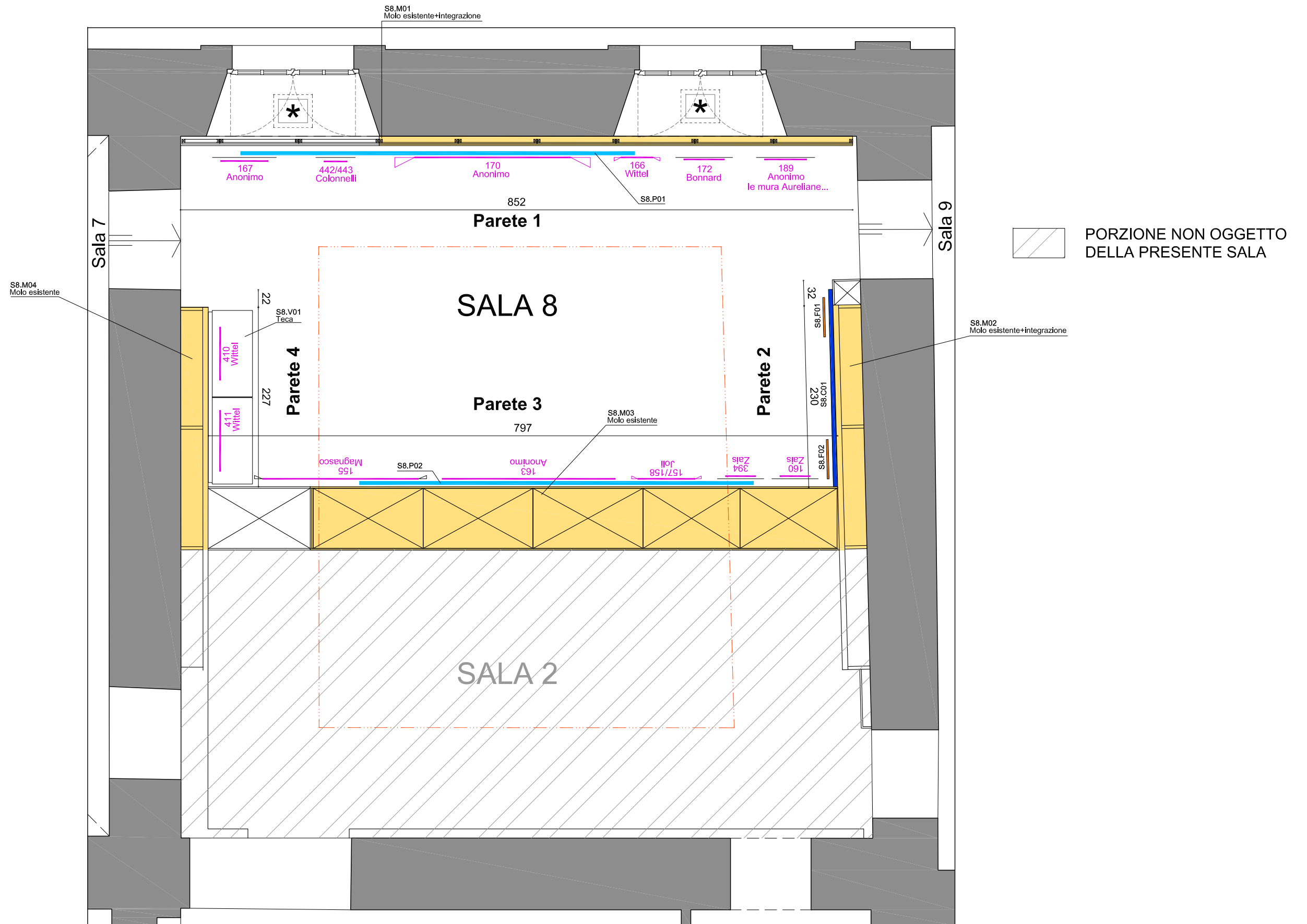

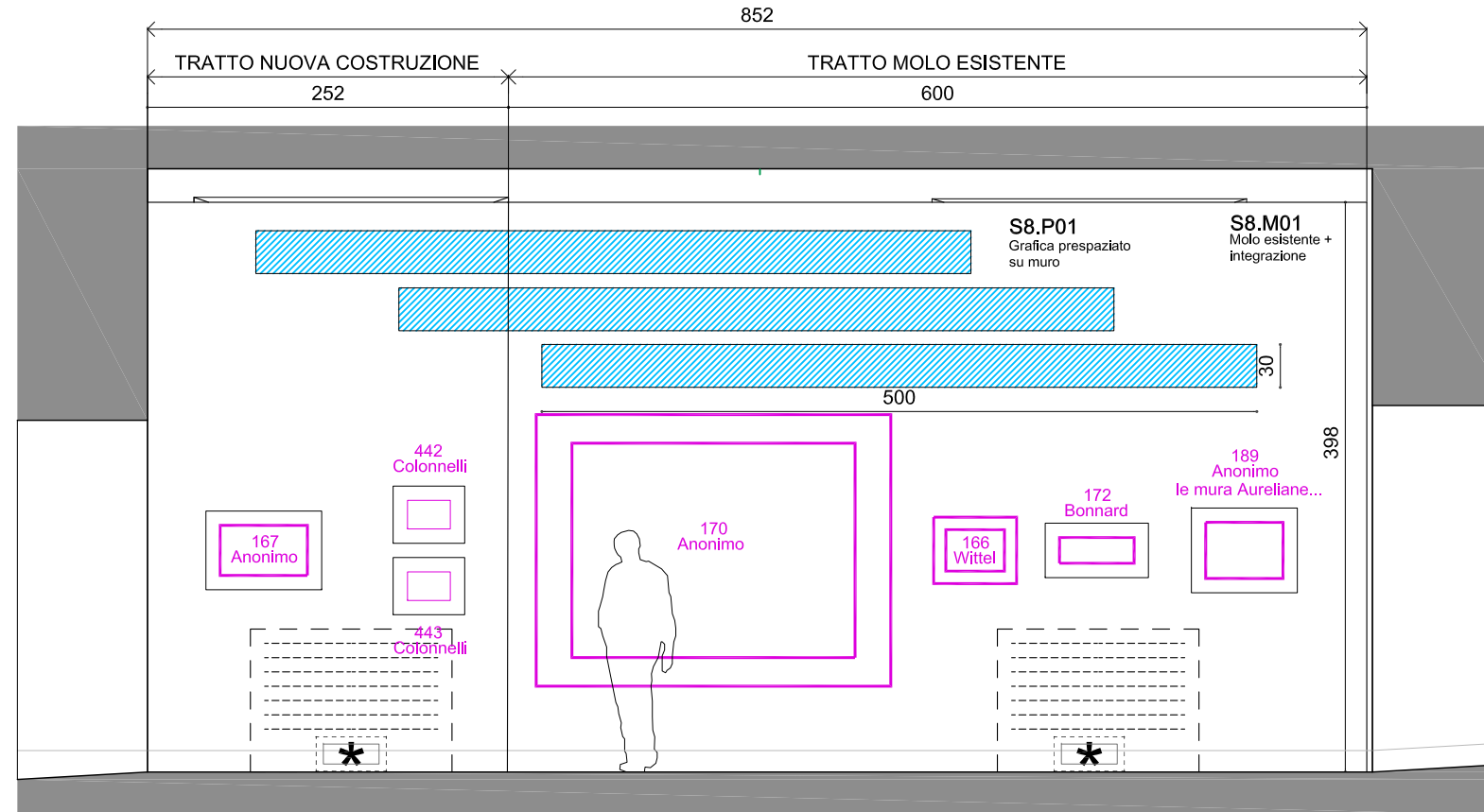

 PORZIONE NON OGGETTO DELLA PRESENTE SALA

Parete 1 TRATTO NUOVA COSTRUZIONE TRATTO MOLO ESISTENTE

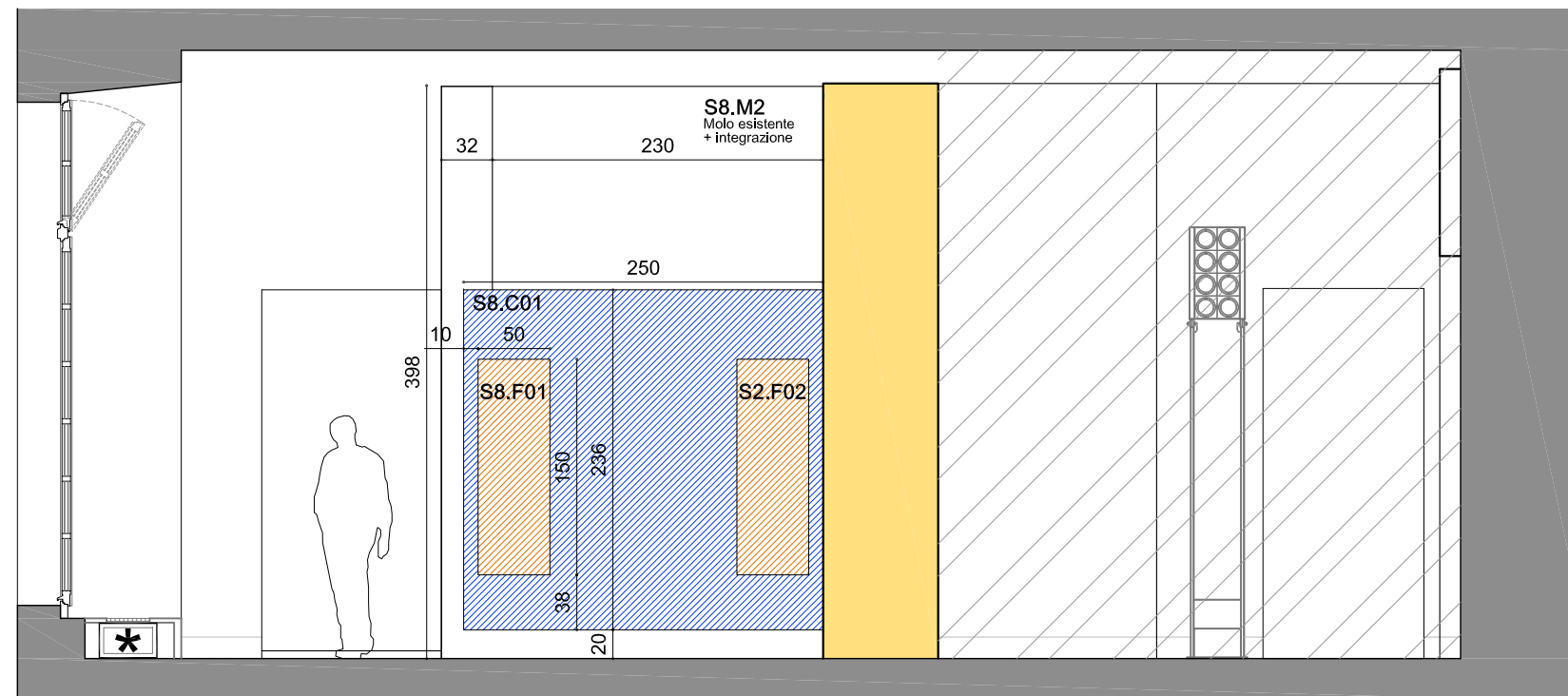

Parete 2

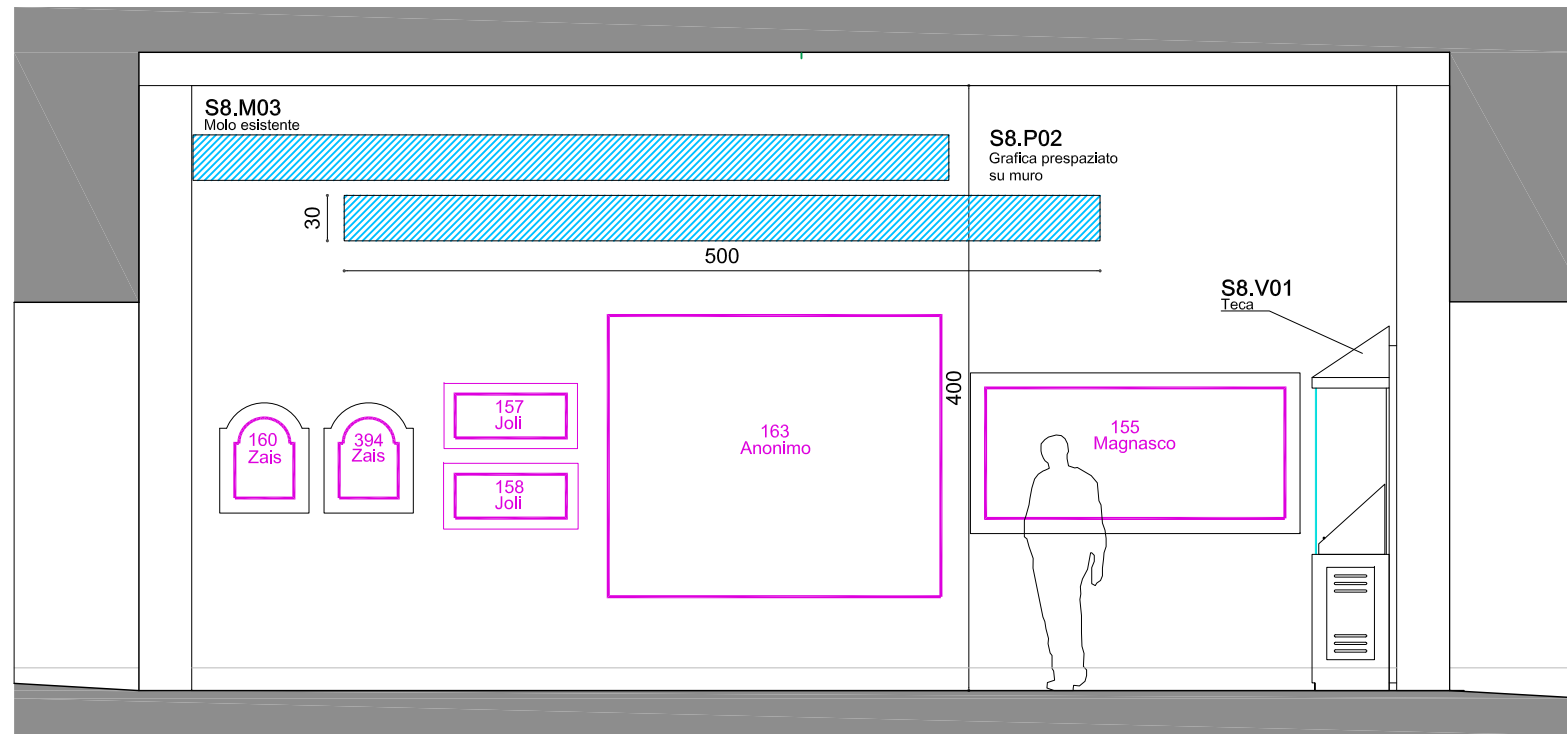

Parete 3

 PORZIONE NON OGGETTO DELLA PRESENTE SALA

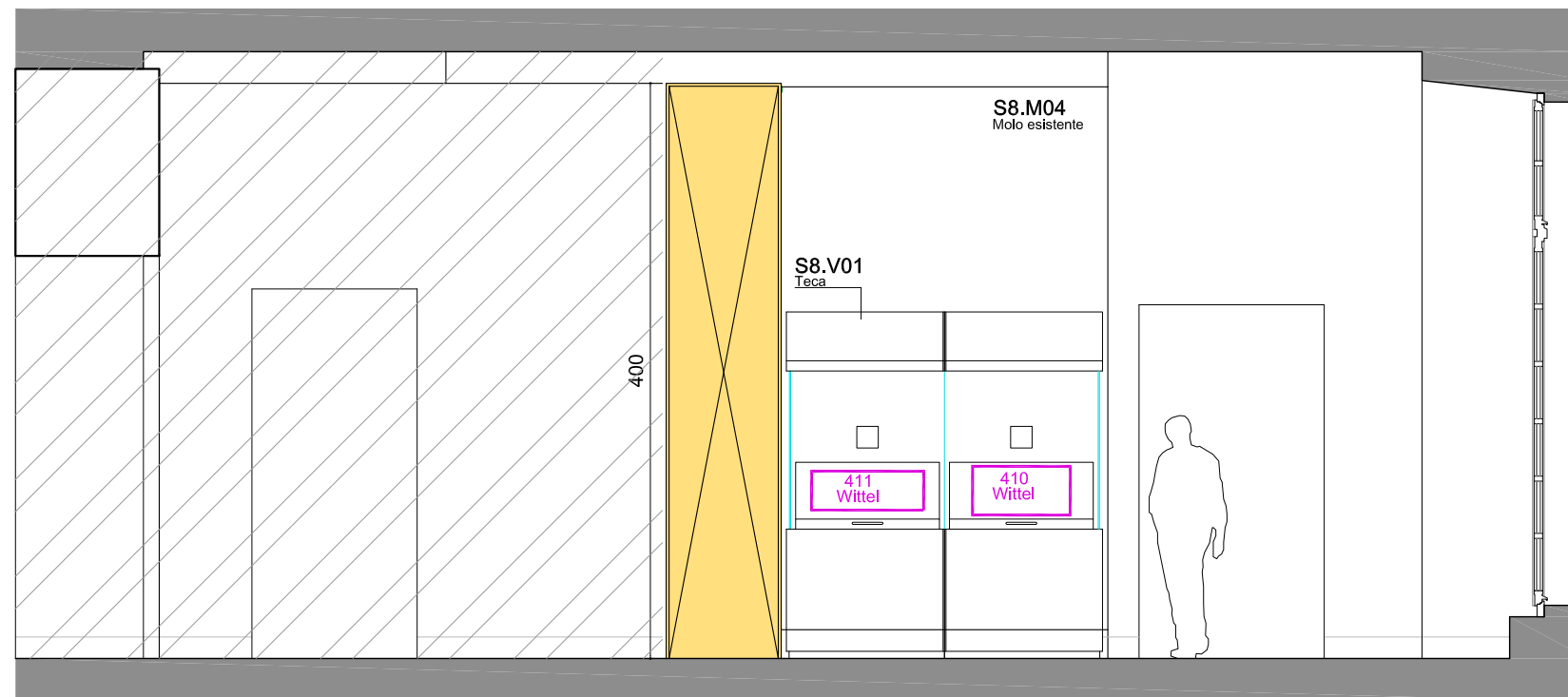

Parete 4

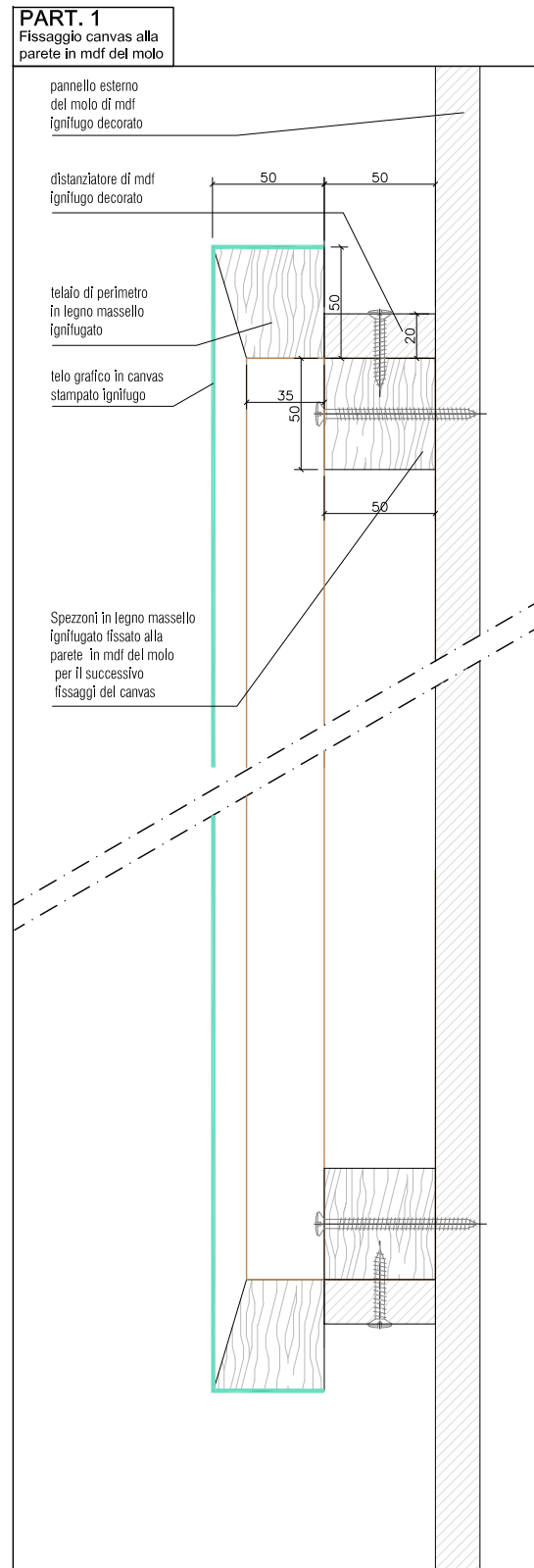
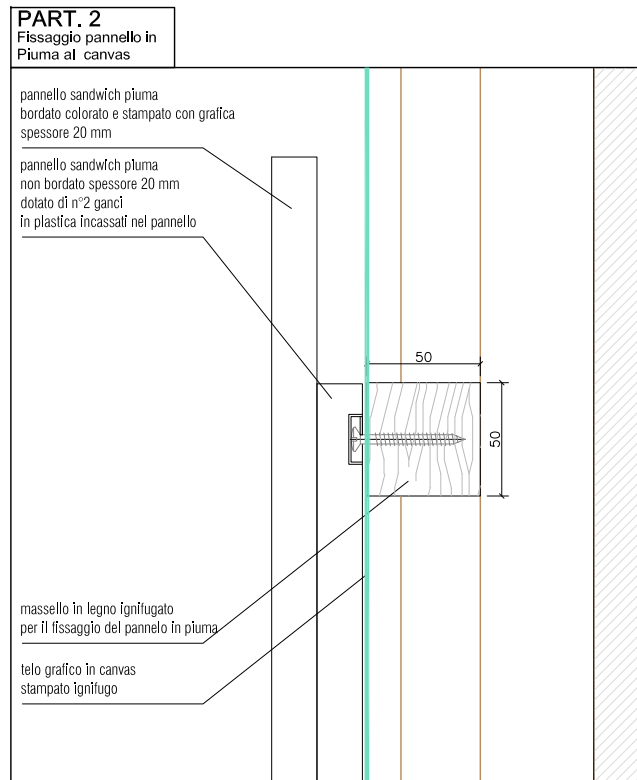

S8.C01
Telaio ligneo sparapuntato con telo grafico realizzato in masselli di legno ignifugato

S8.F01/F02
Doppio pannello in piuma spessore 20 mm

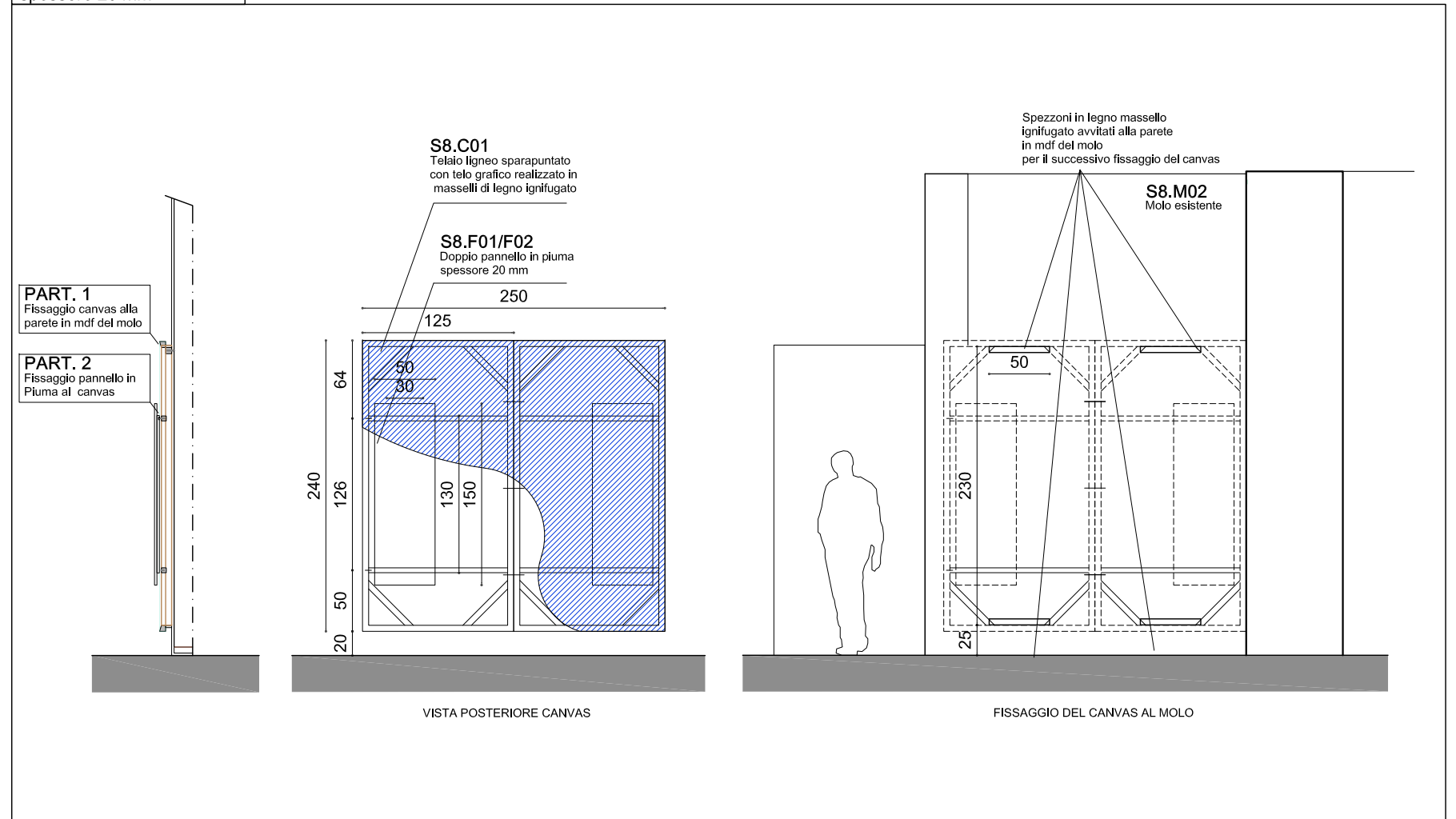

PIANTA C

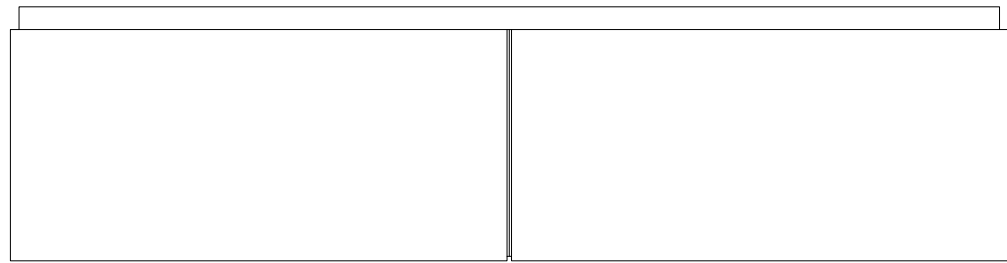

PIANTA B

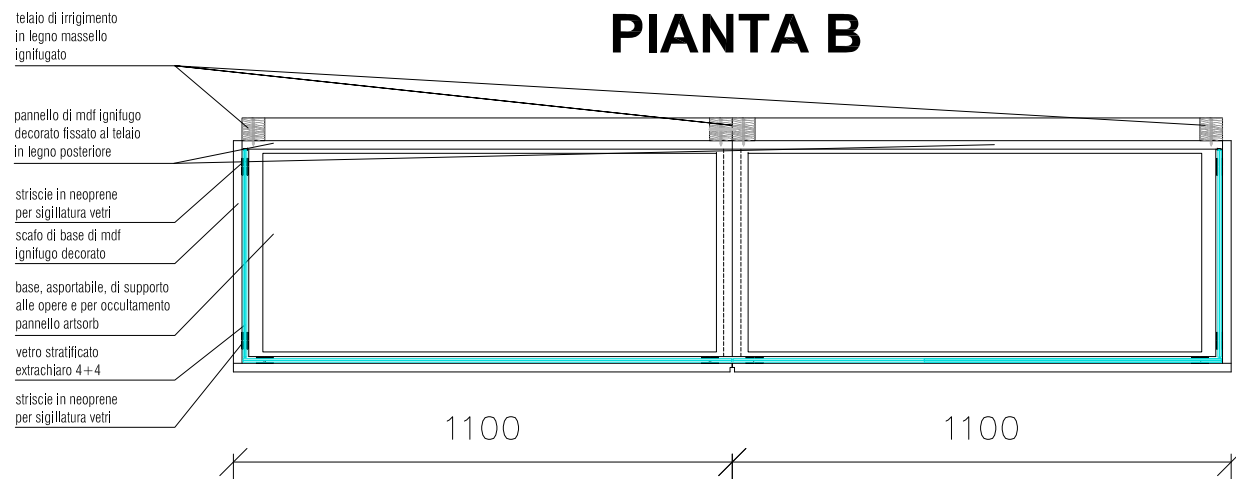

PIANTA A

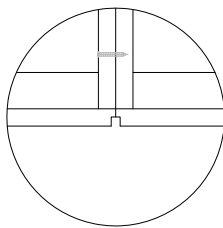
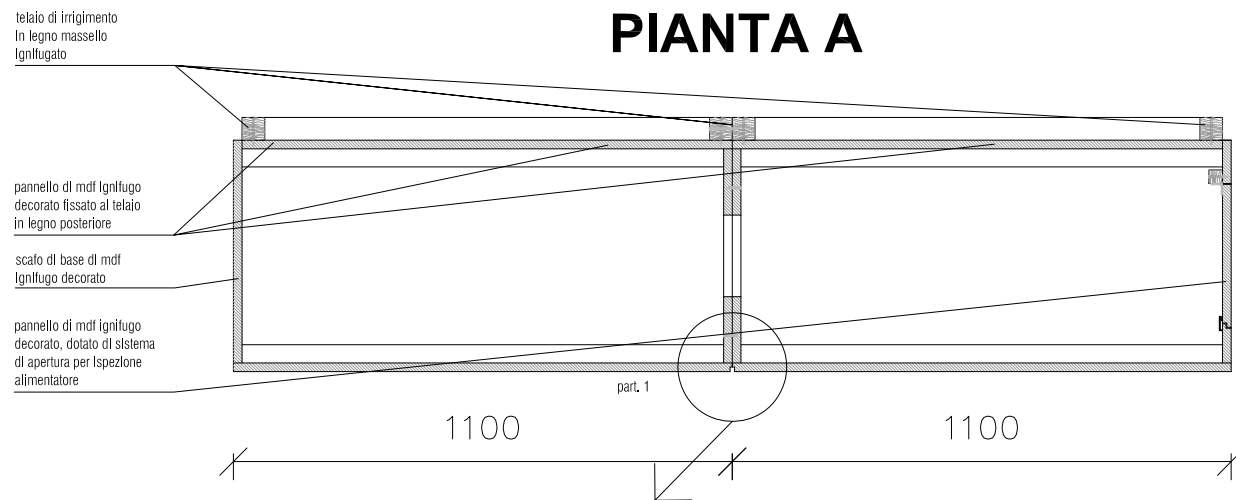

D

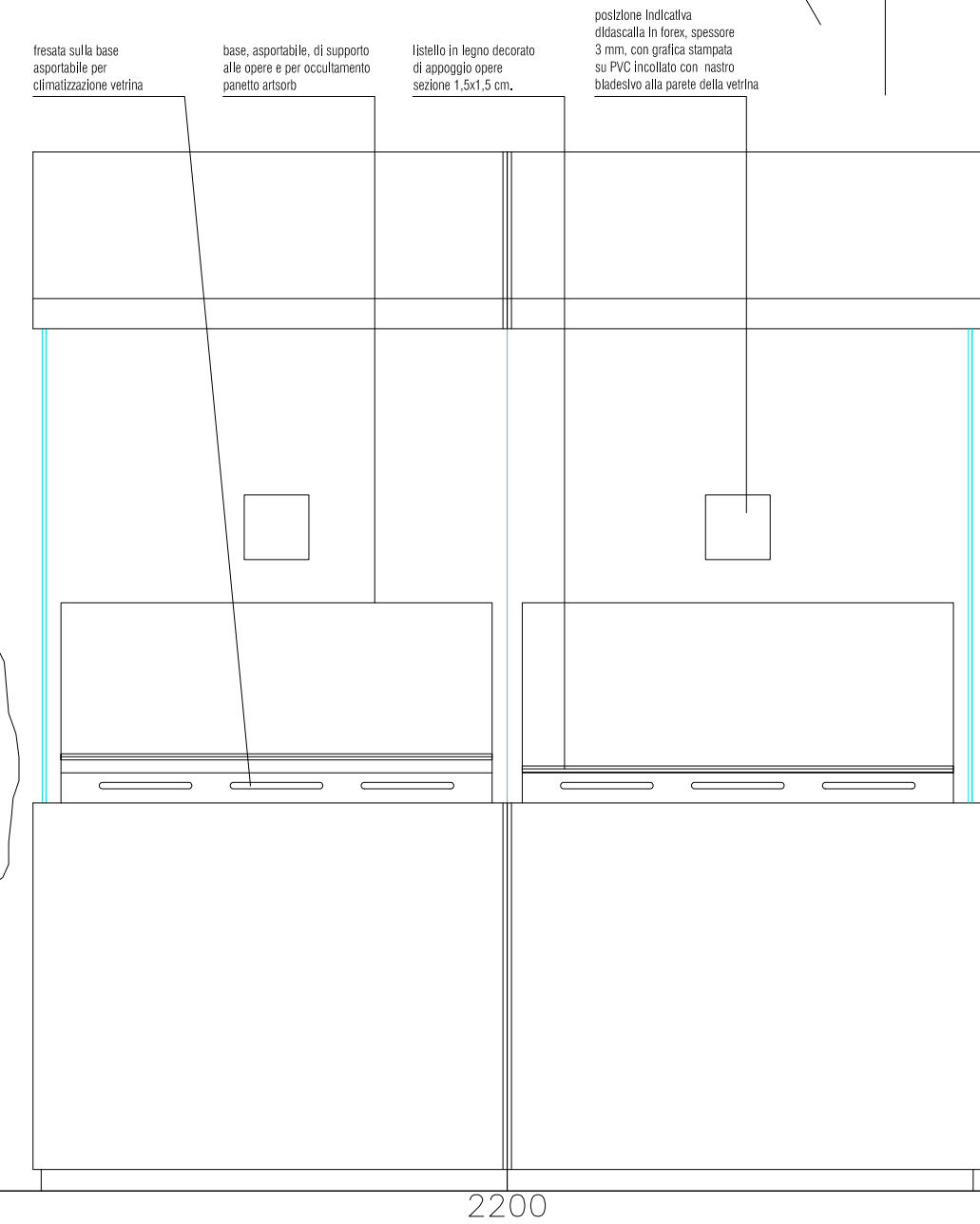

PROSPETTO FRONTALE

S8.V01
Teca

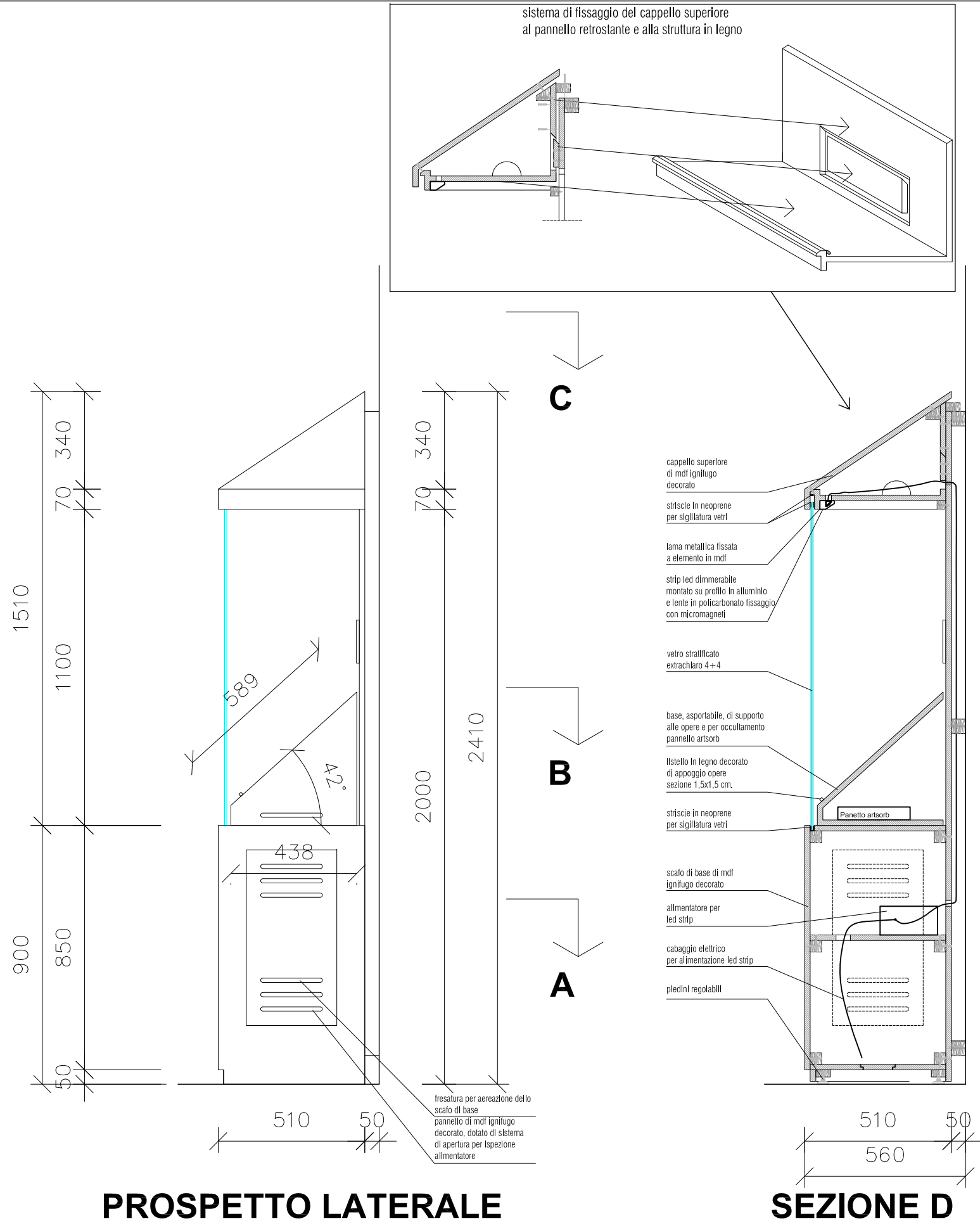

PROSPETTO LATERALE

SEZIONE D

DETTAGLIO SIGILLATURA VETRI

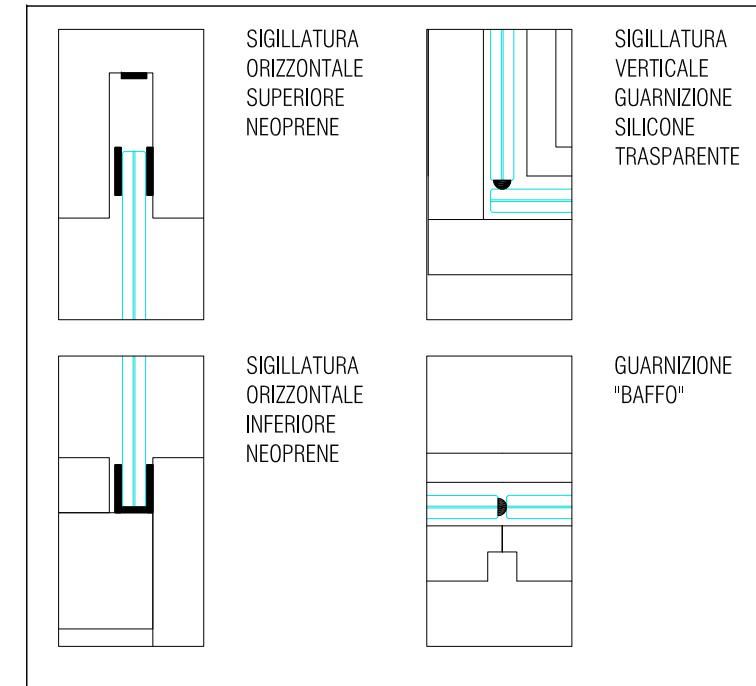

S8.V01
Teca

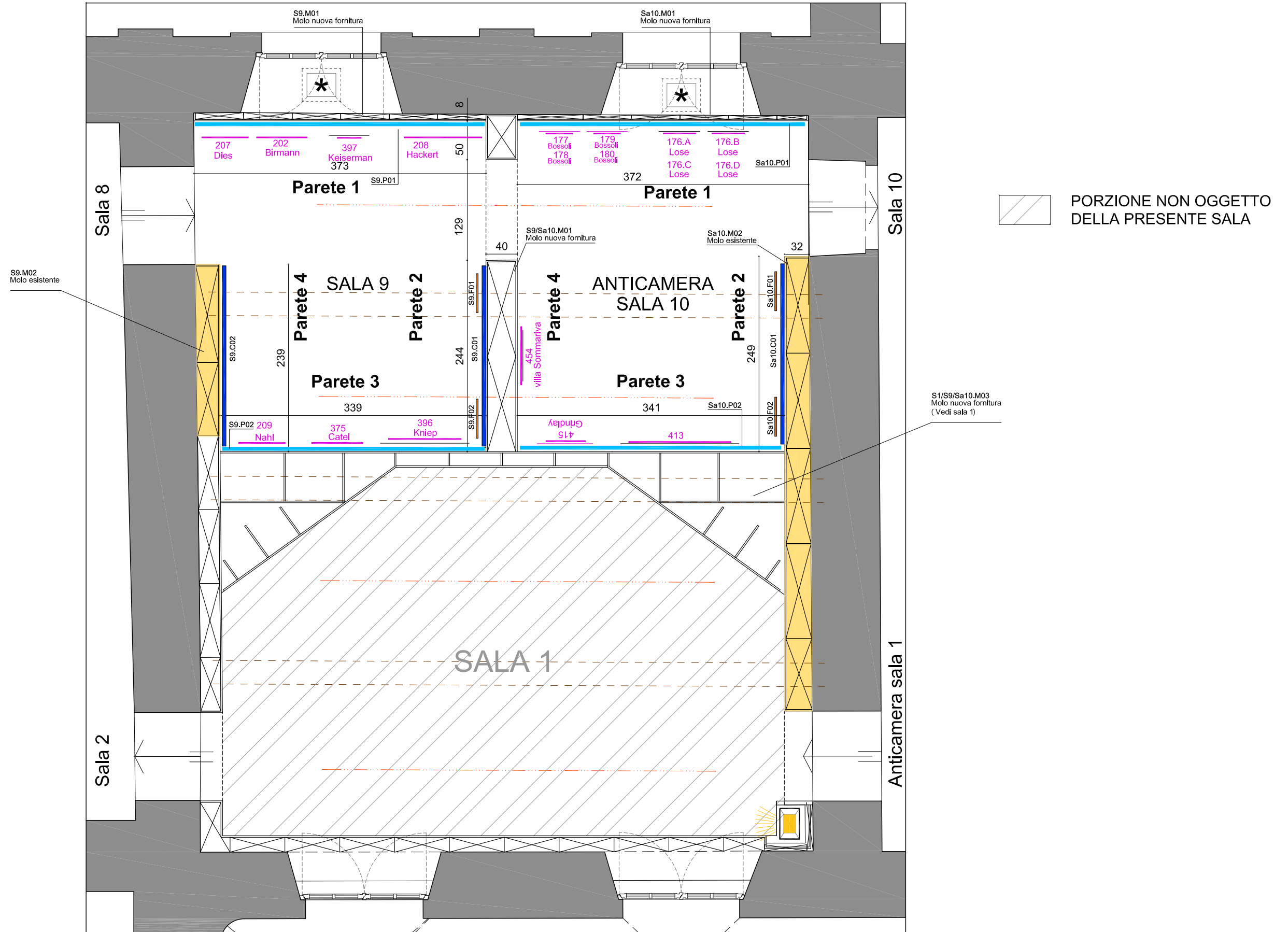

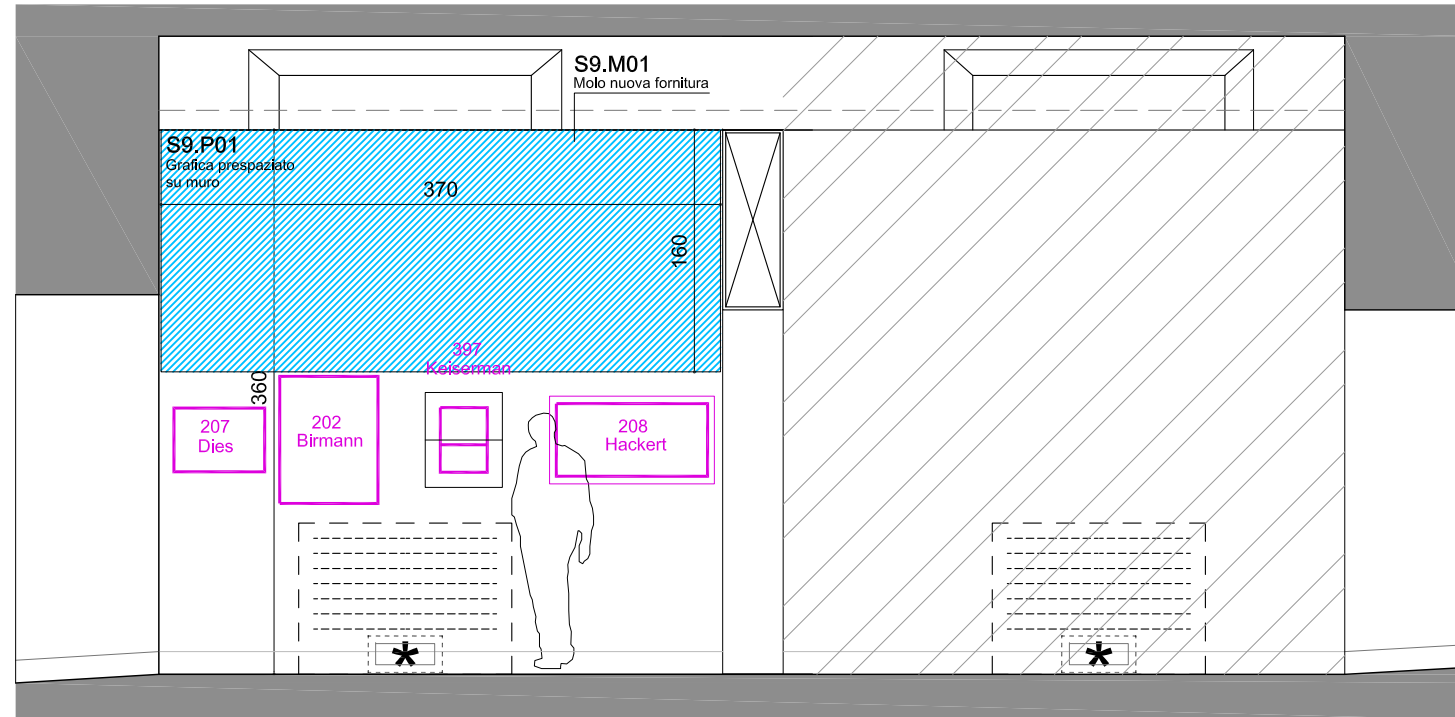

 PORZIONE NON OGGETTO DELLA PRESENTE SALA

Parete 1

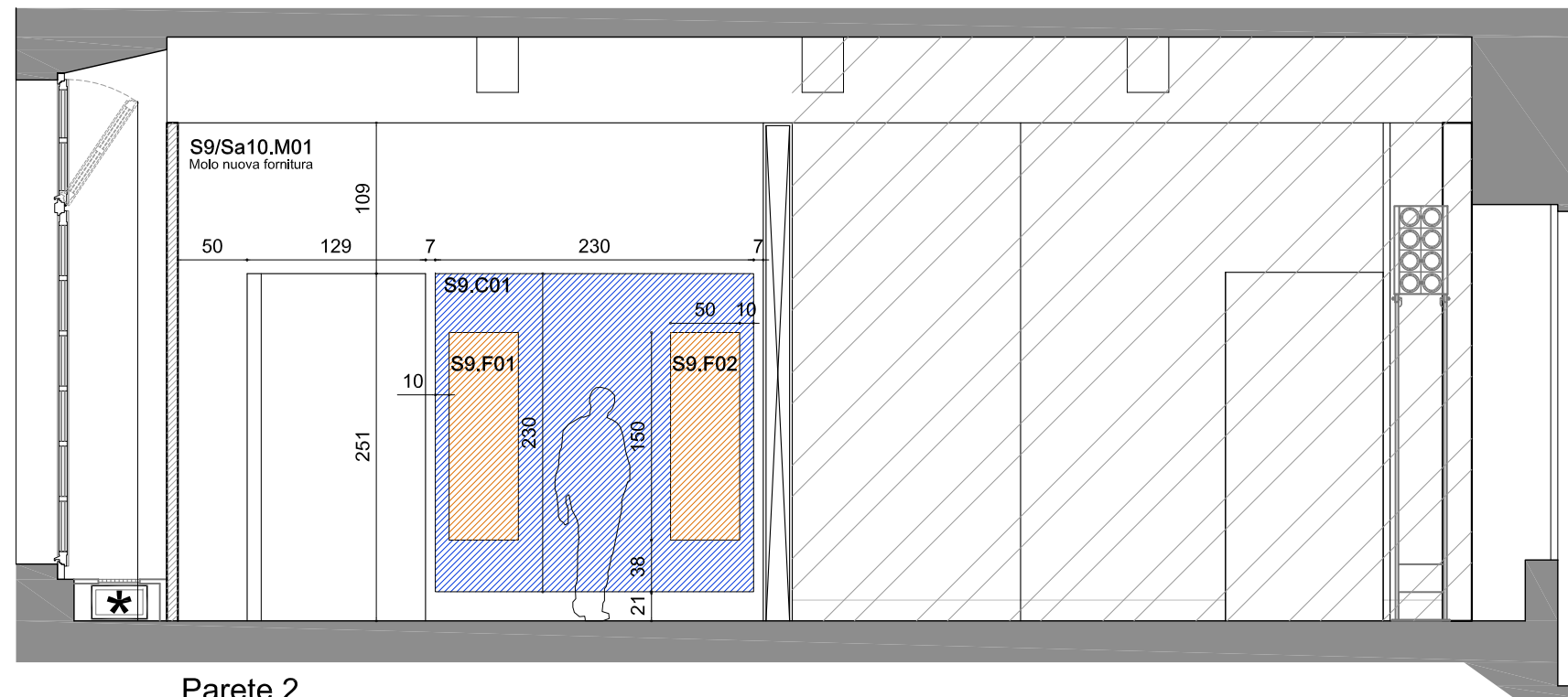

Parete 2

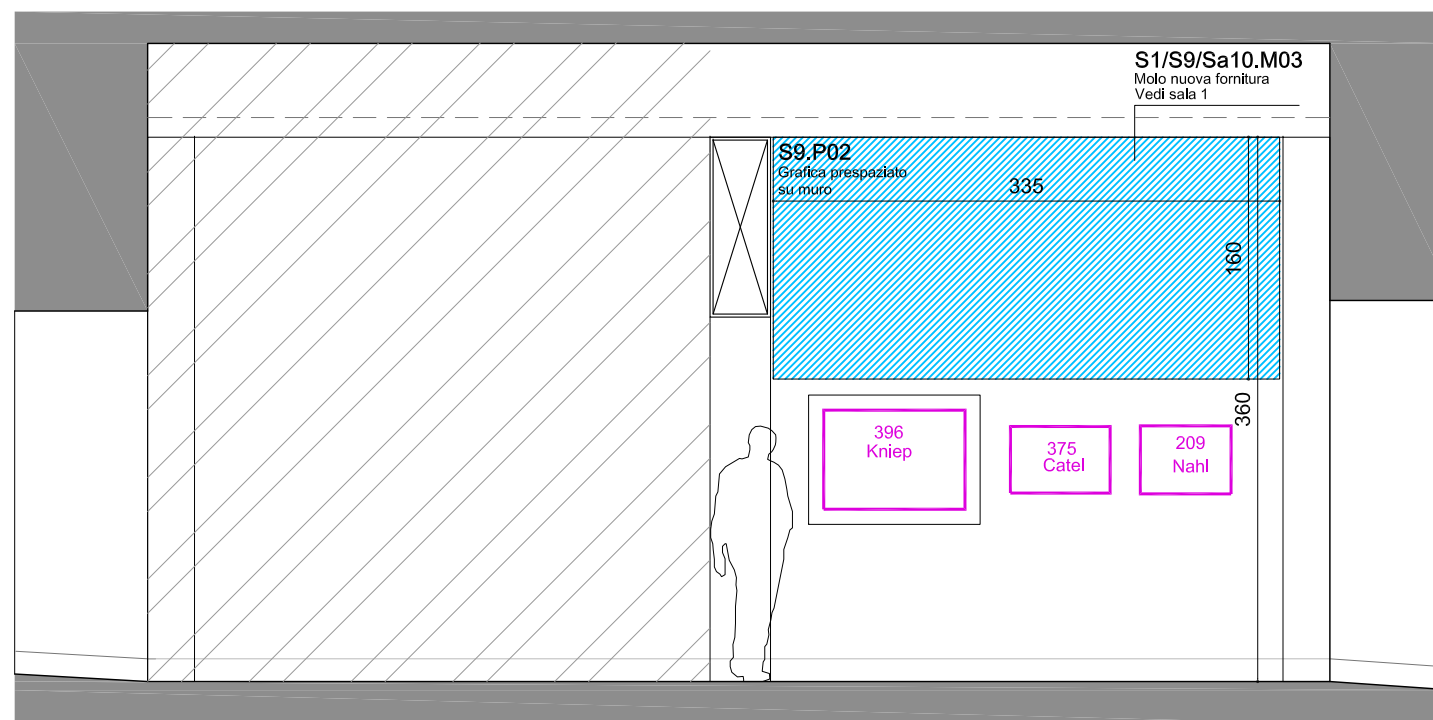

 PORZIONE NON OGGETTO DELLA PRESENTE SALA

Parete 3

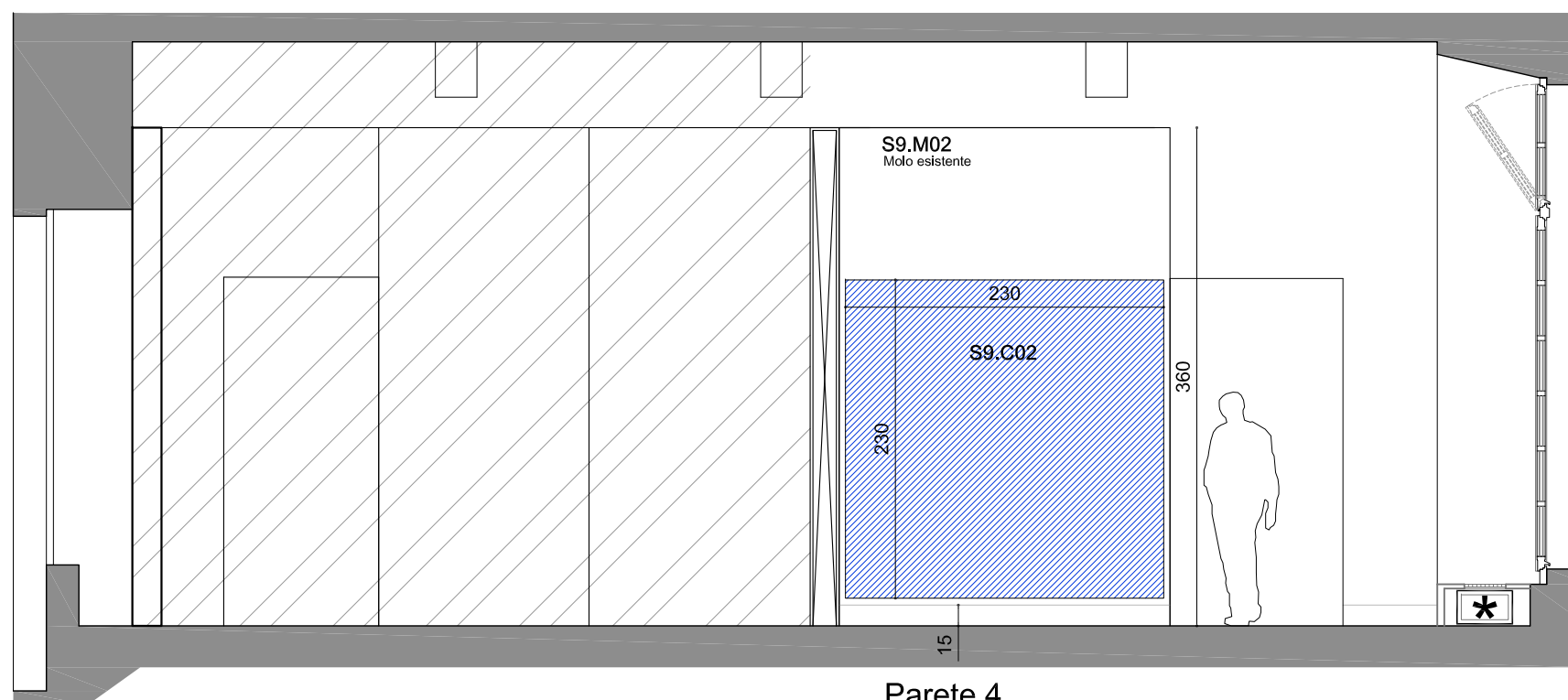

Parete 4

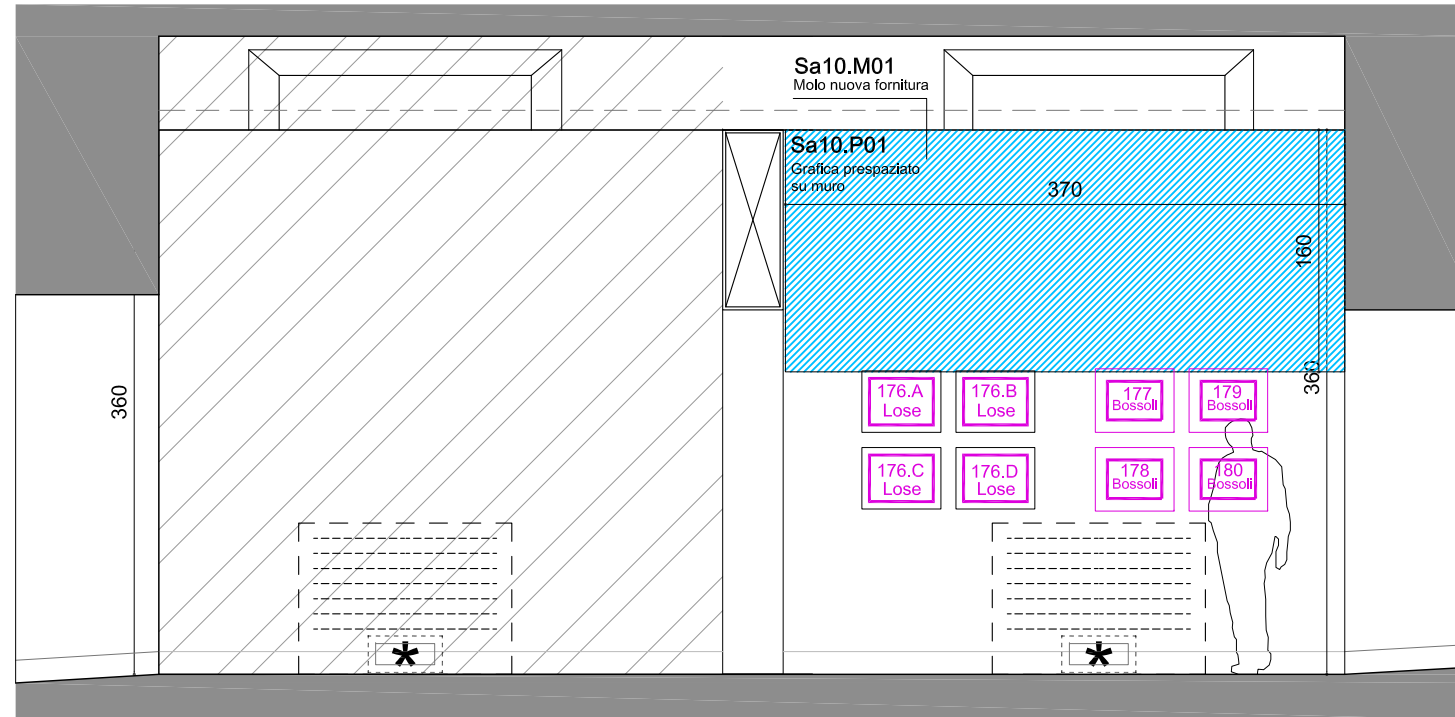

 PORZIONE NON OGGETTO DELLA PRESENTE SALA

Parete 1

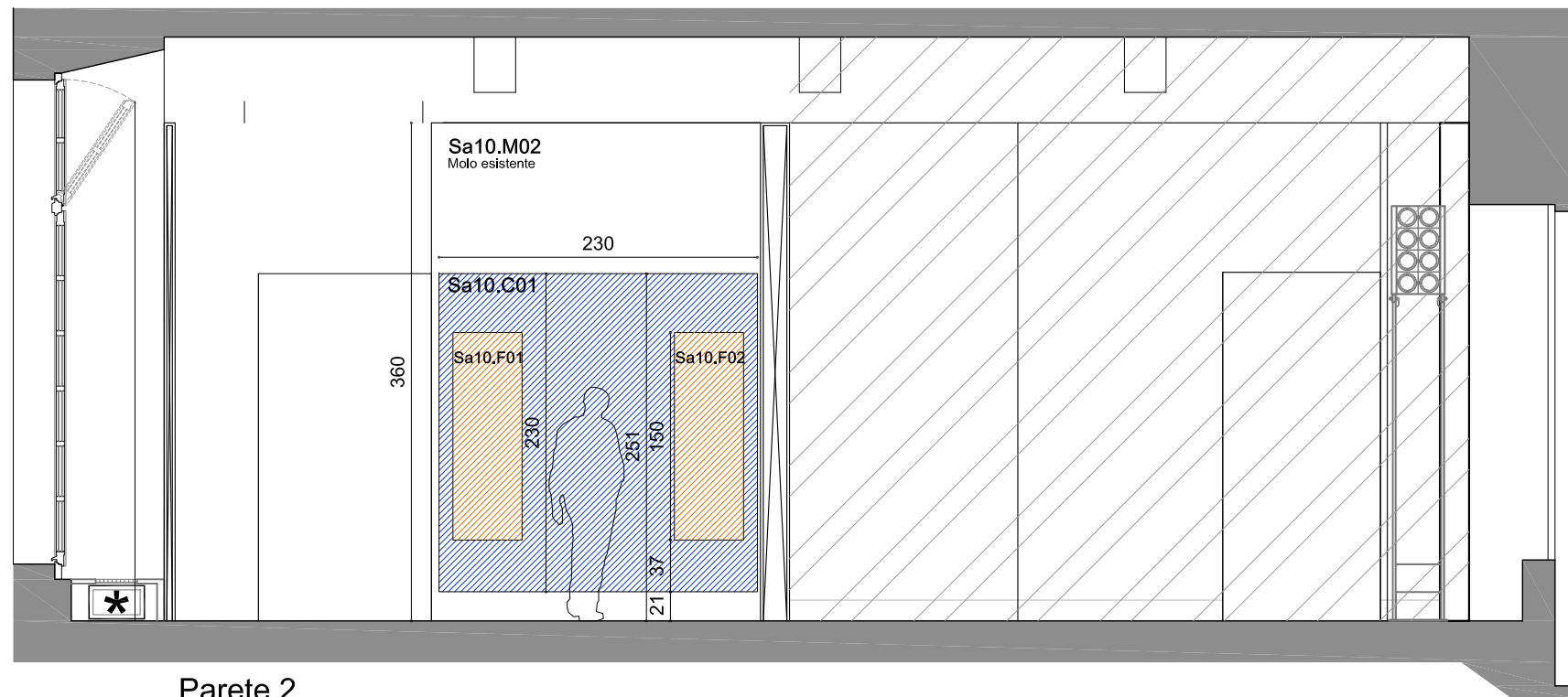

Parete 2

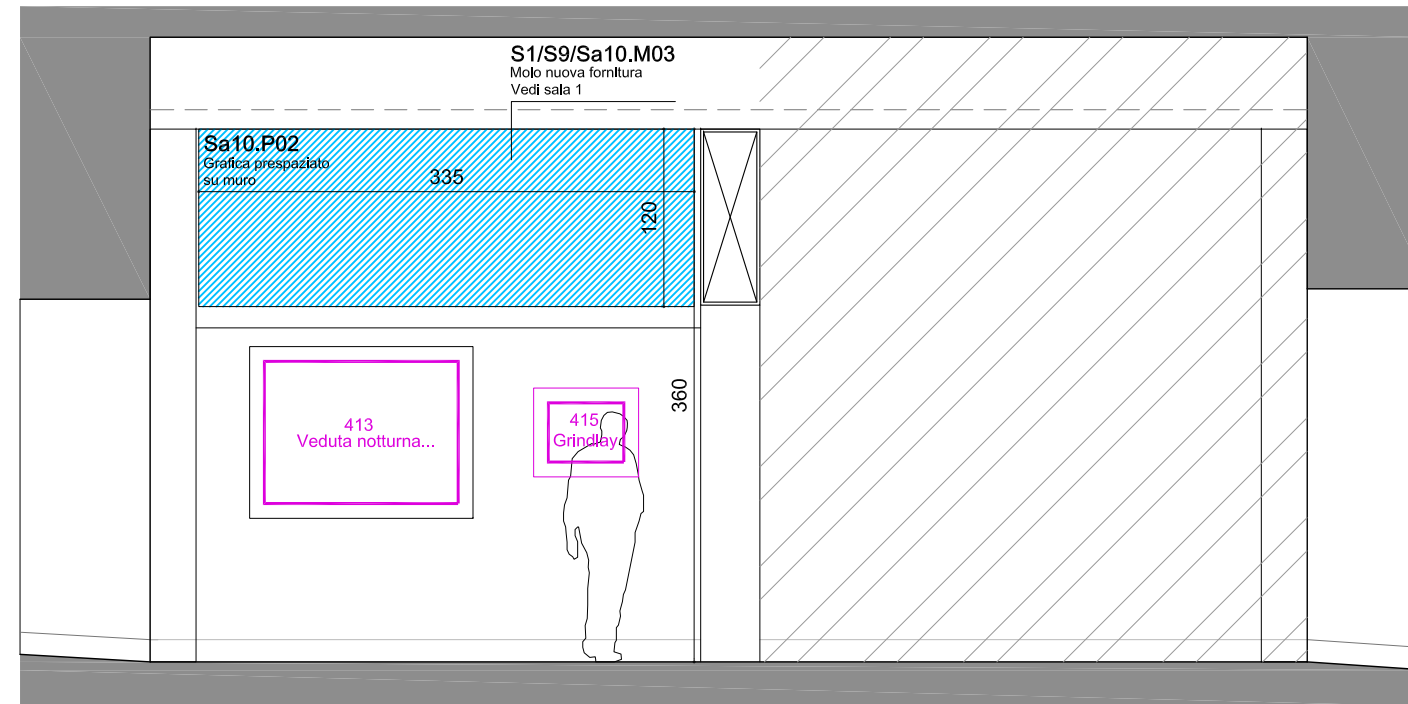

 PORZIONE NON OGGETTO DELLA PRESENTE SALA

Parete 3

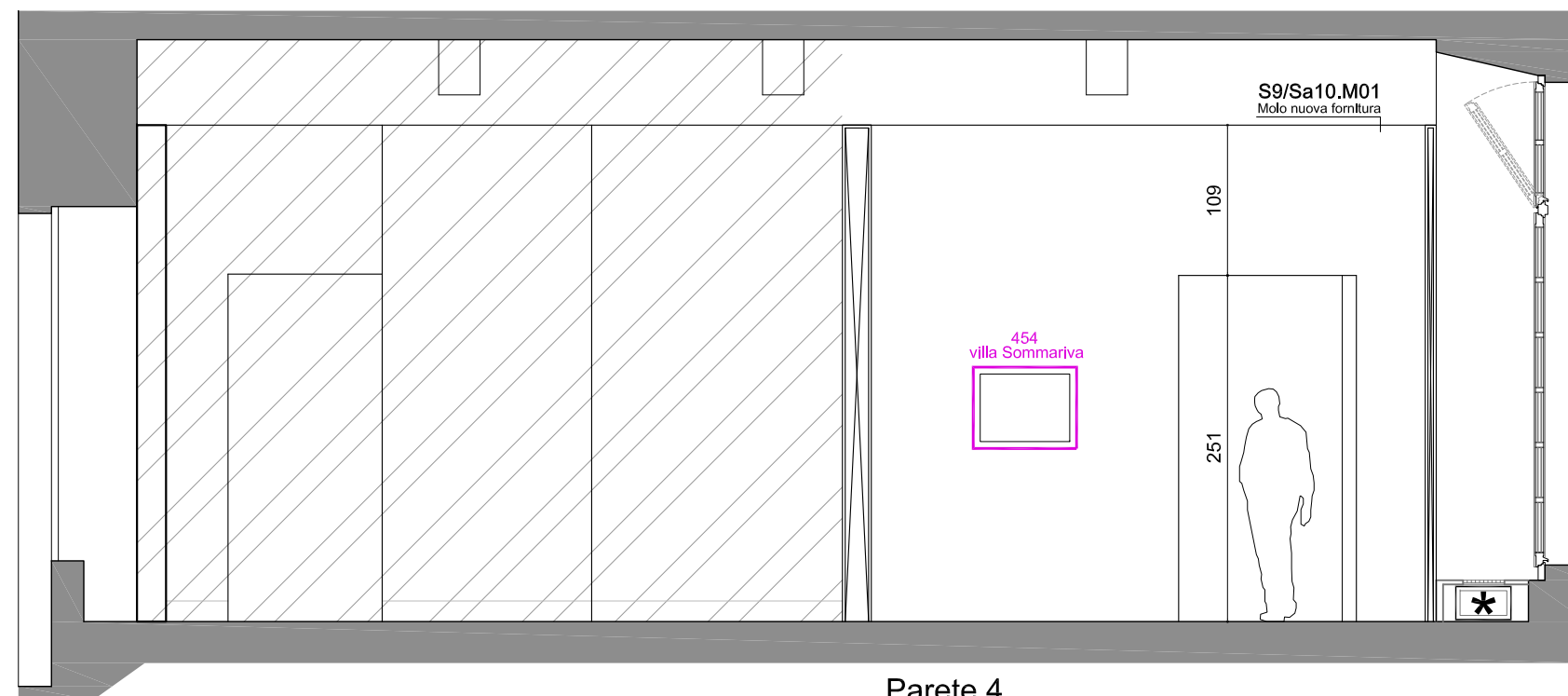

Parete 4

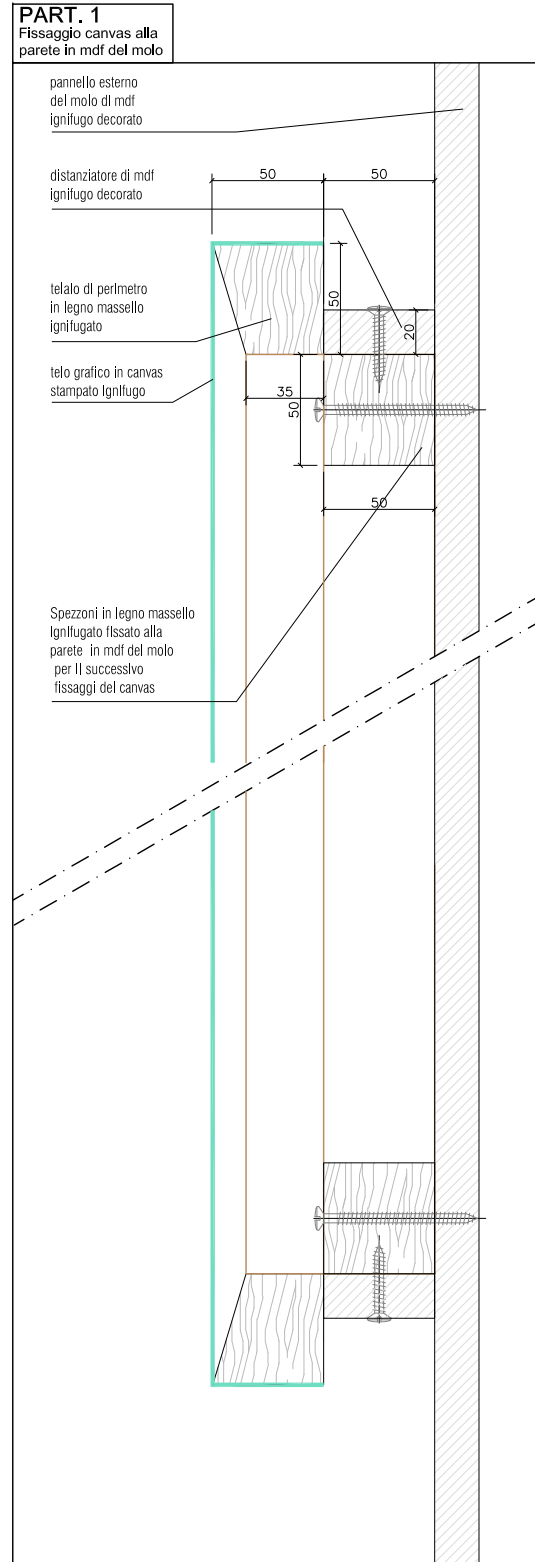

S9.C01
Sa10.C01
Telaio ligneo sparapuntato con telo grafico realizzato in masselli di legno ignifugato

S9.F01/F02
Sa10.F01/F02
Doppio pannello in piuma spessore 20 mm

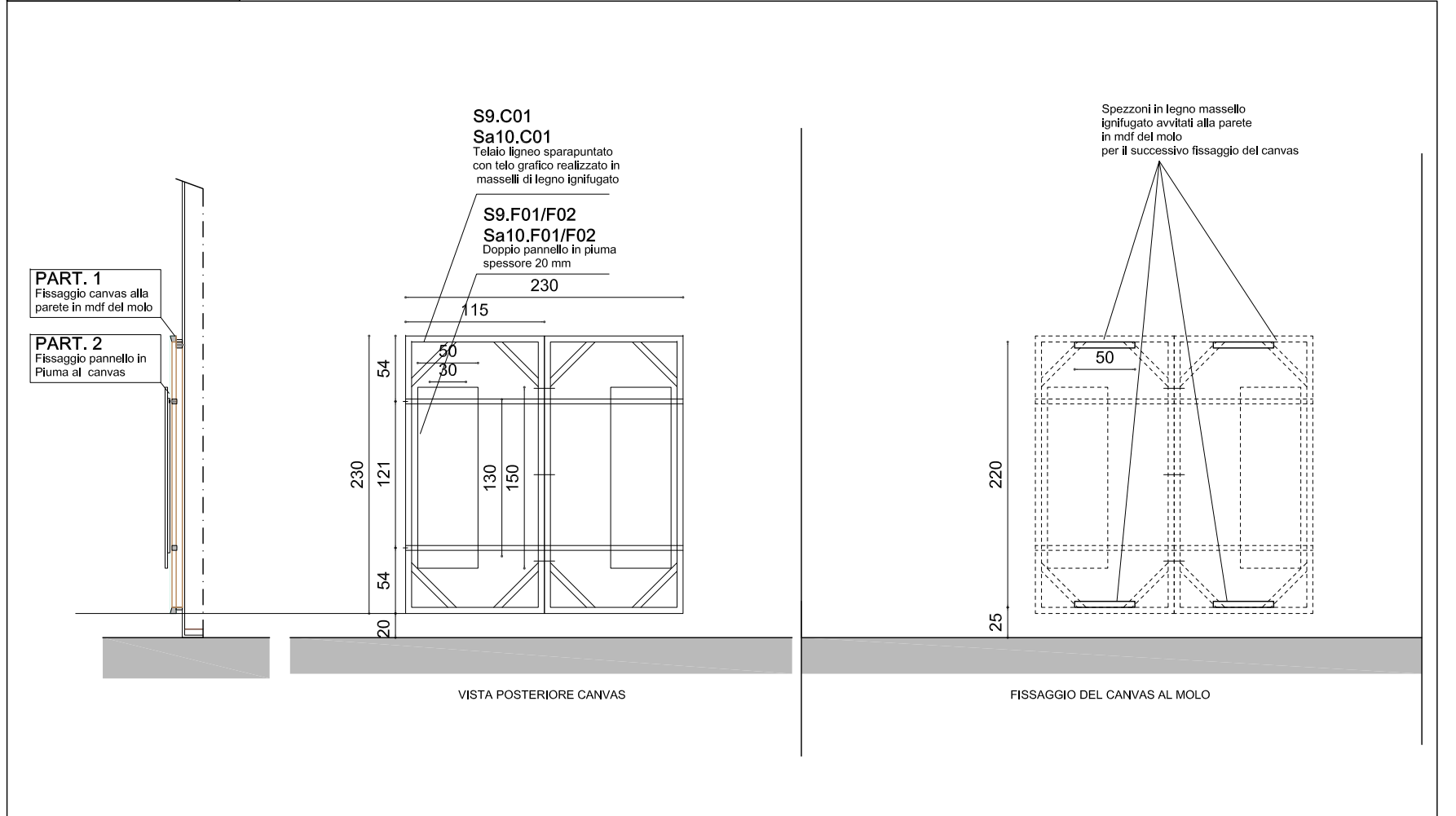
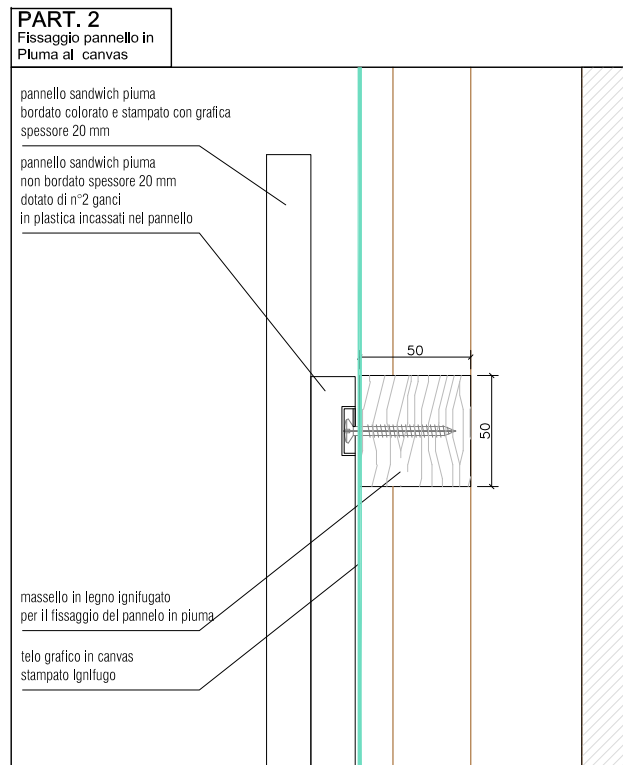

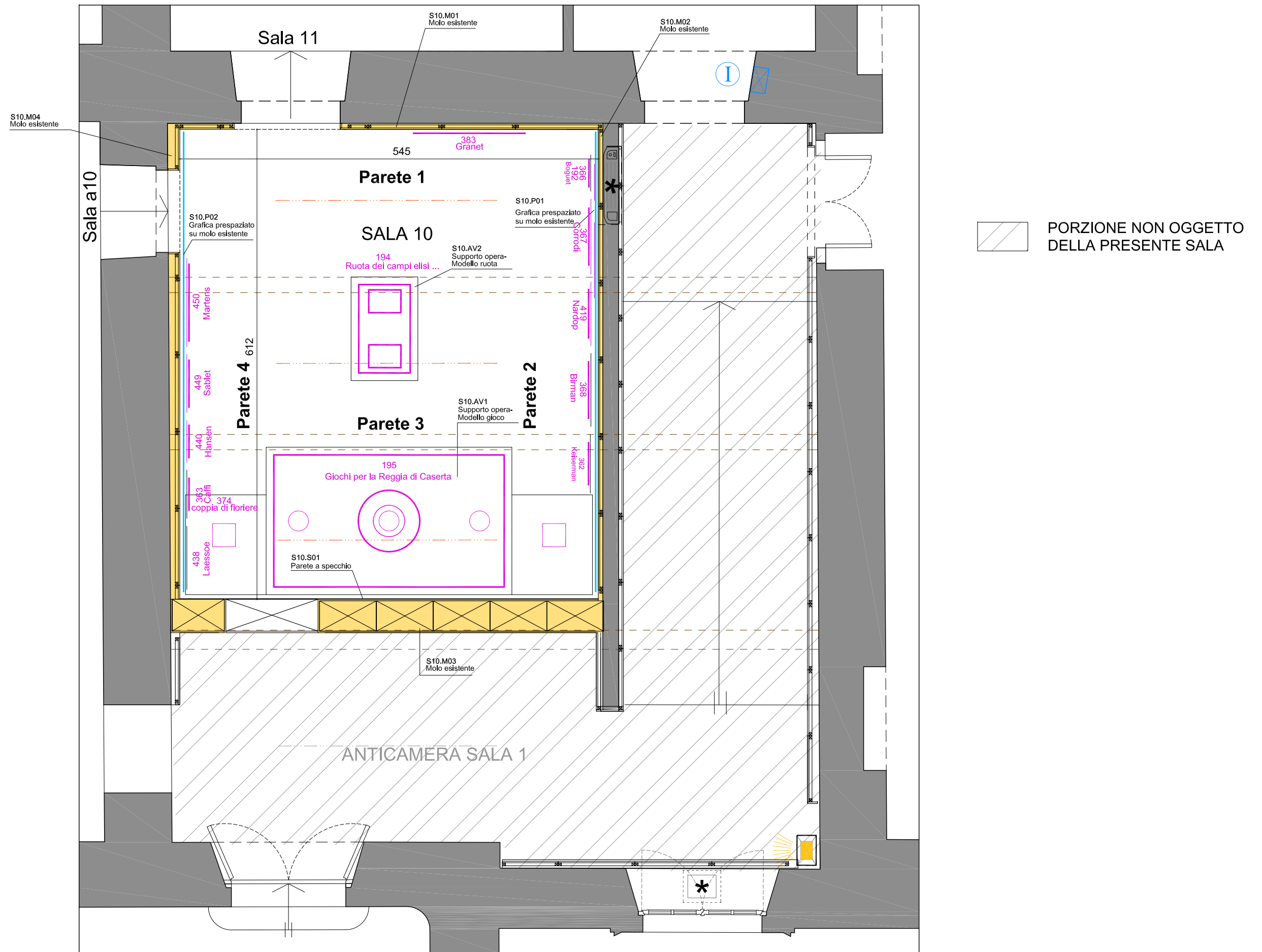

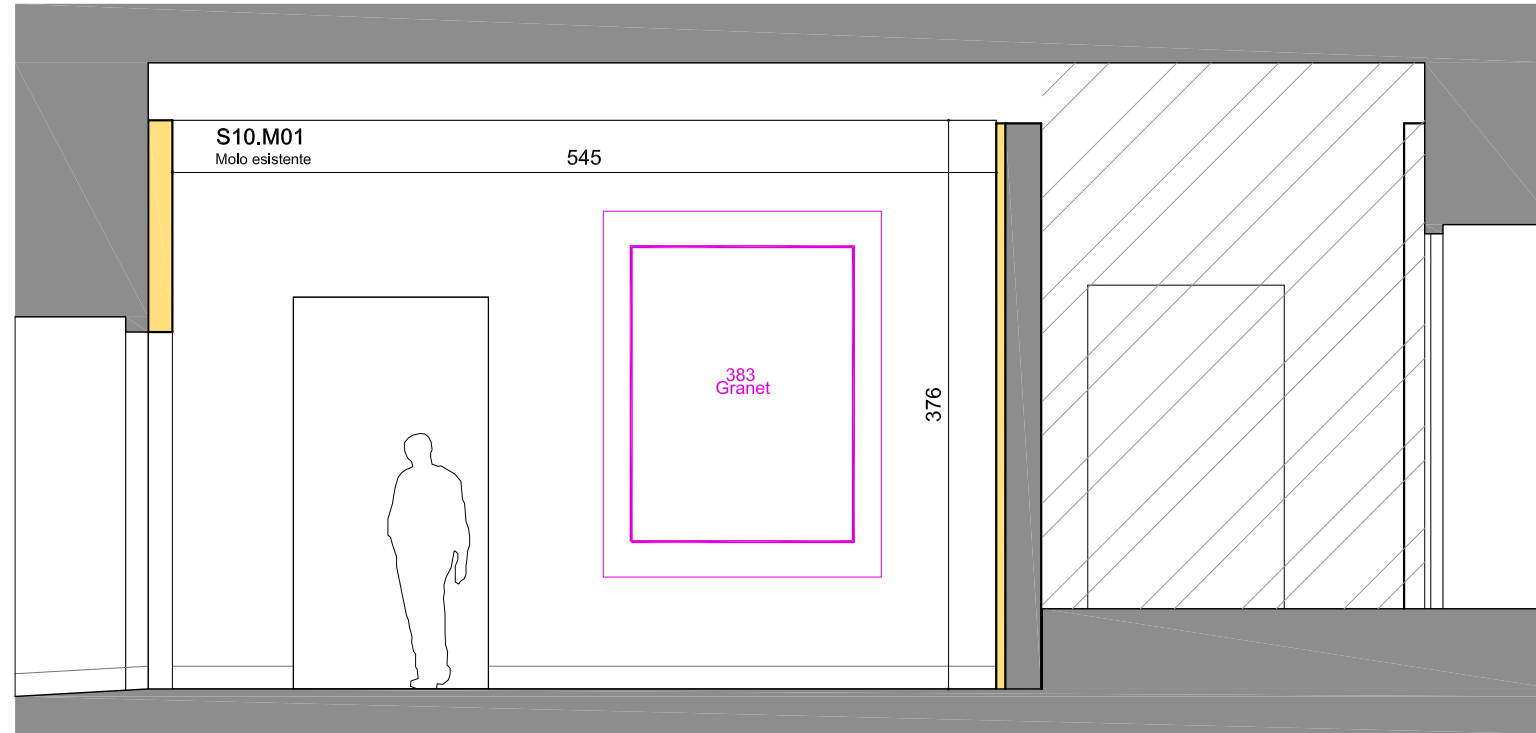

Parete 1

 PORZIONE NON OGGETTO DELLA PRESENTE SALA

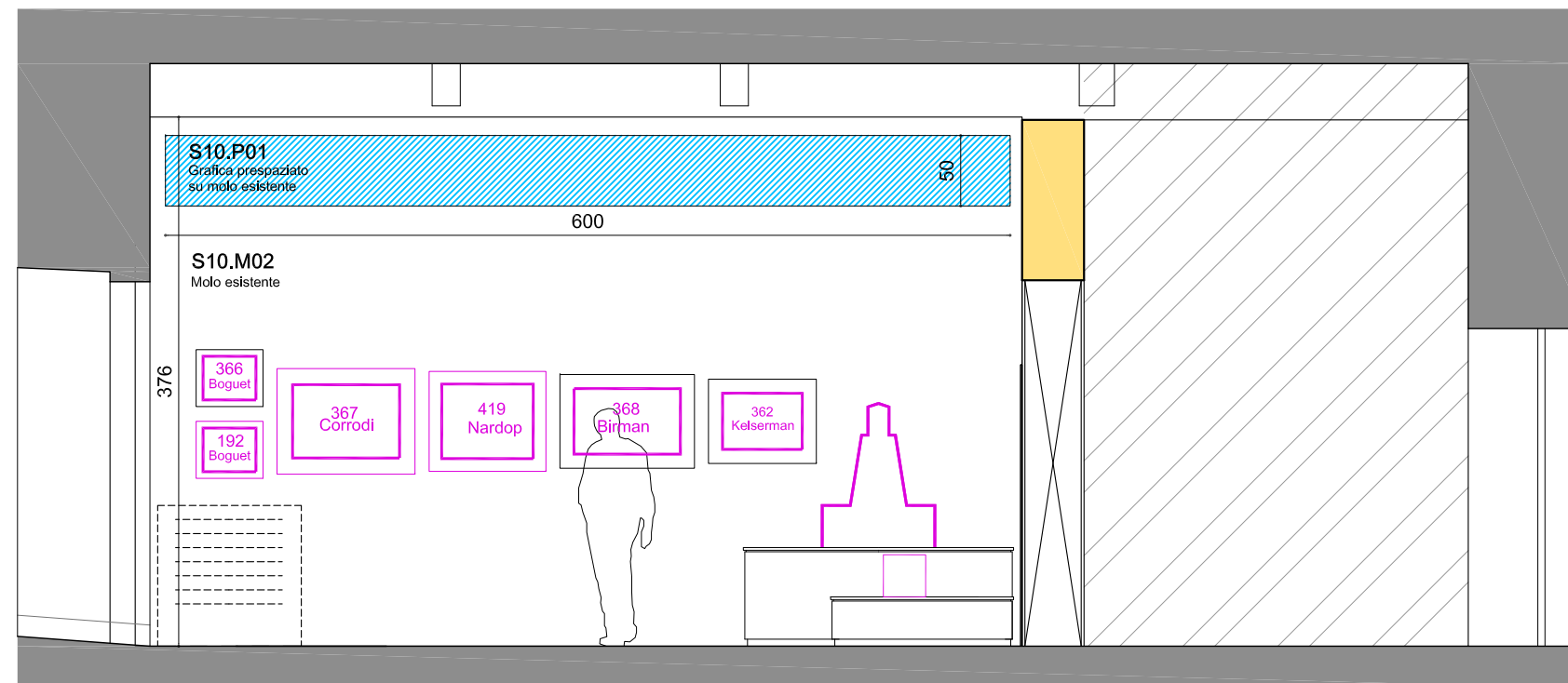

Parete 2

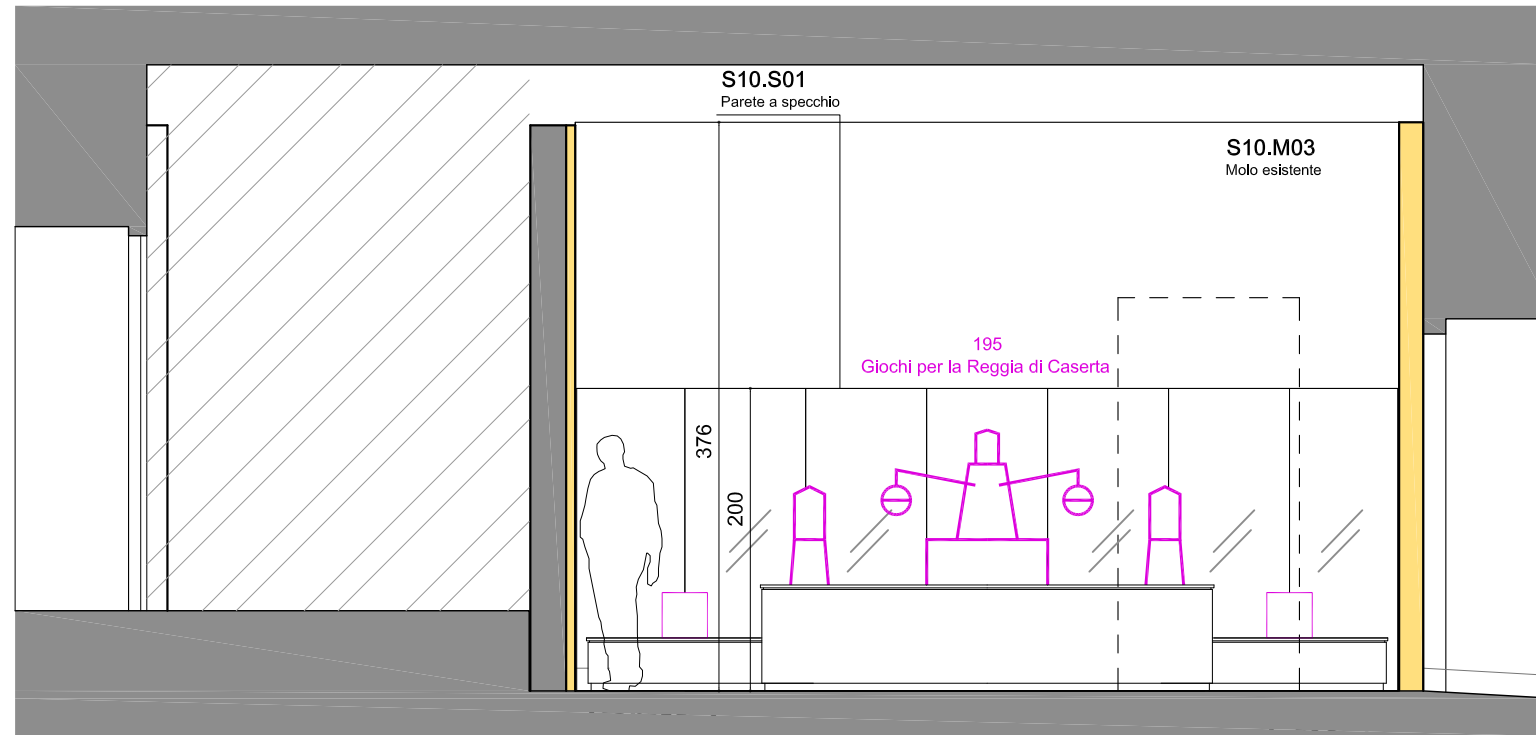

Parete 3

 PORZIONE NON OGGETTO DELLA PRESENTE SALA

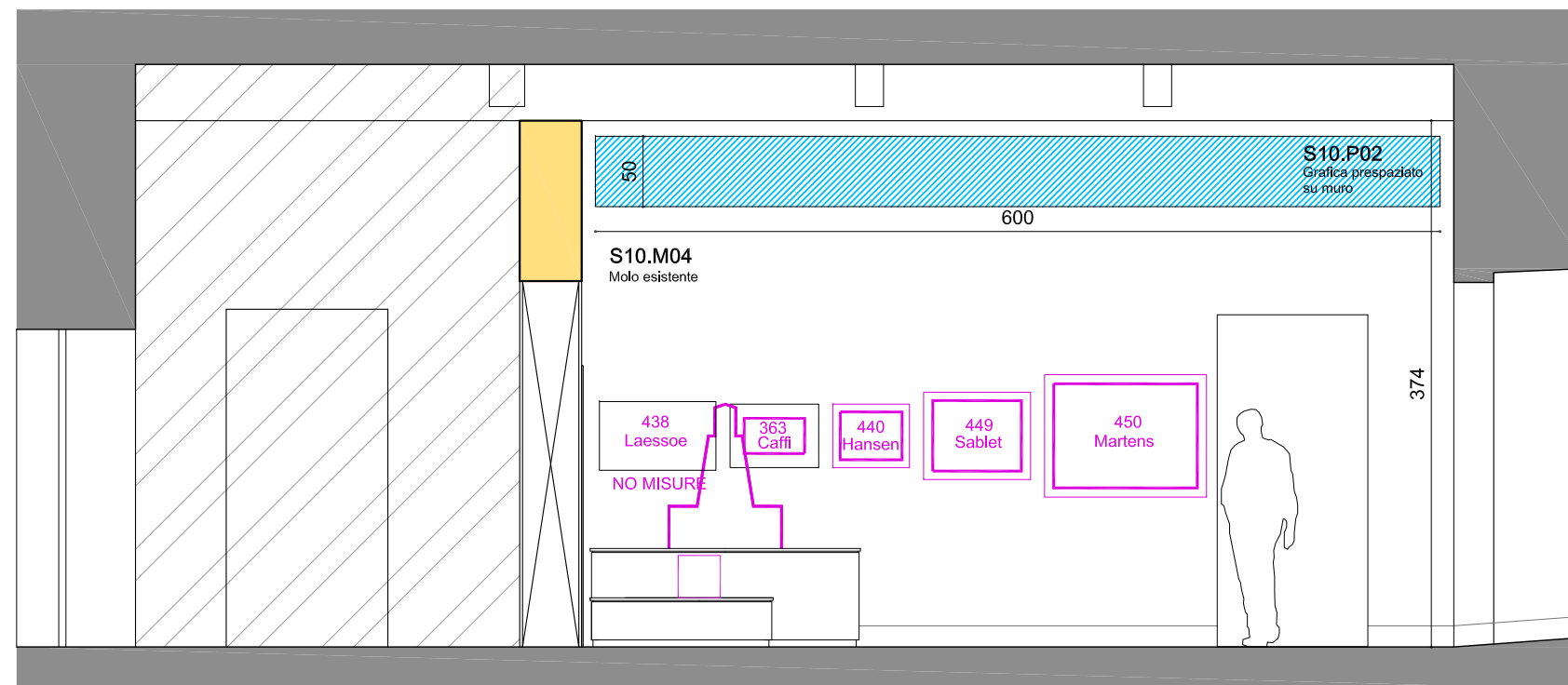

Parete 4

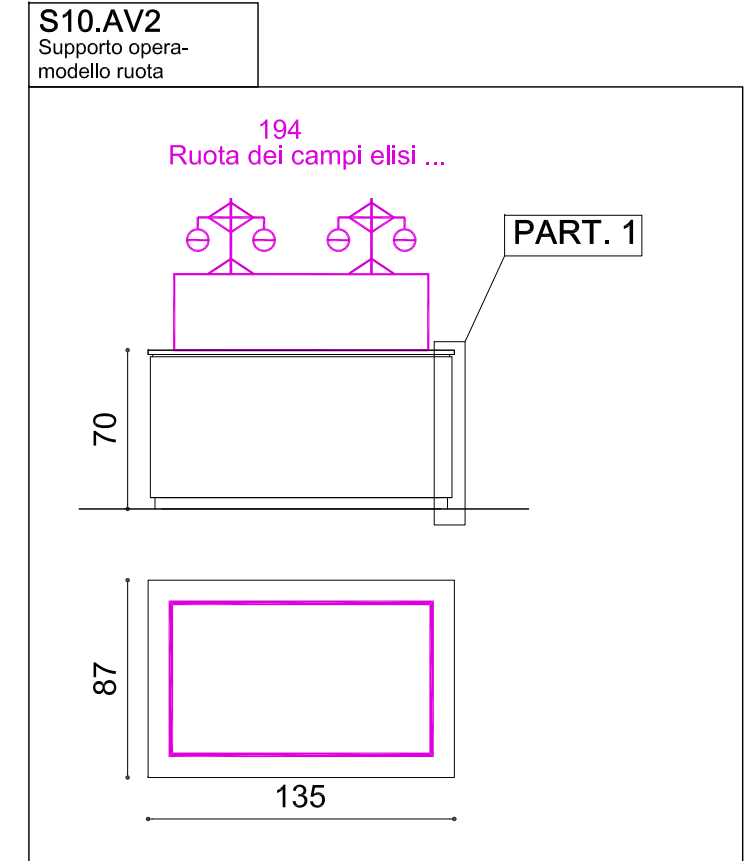
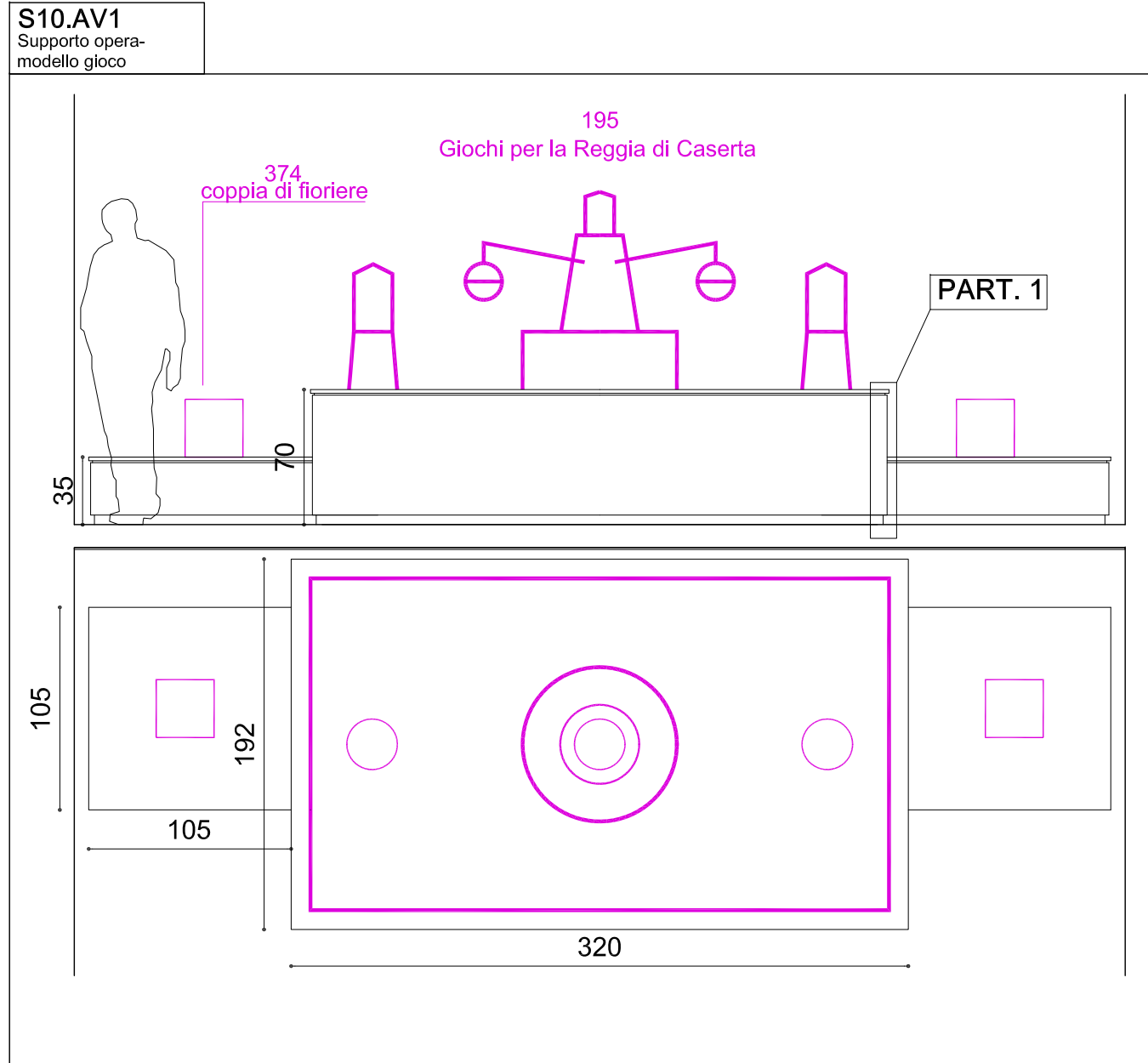
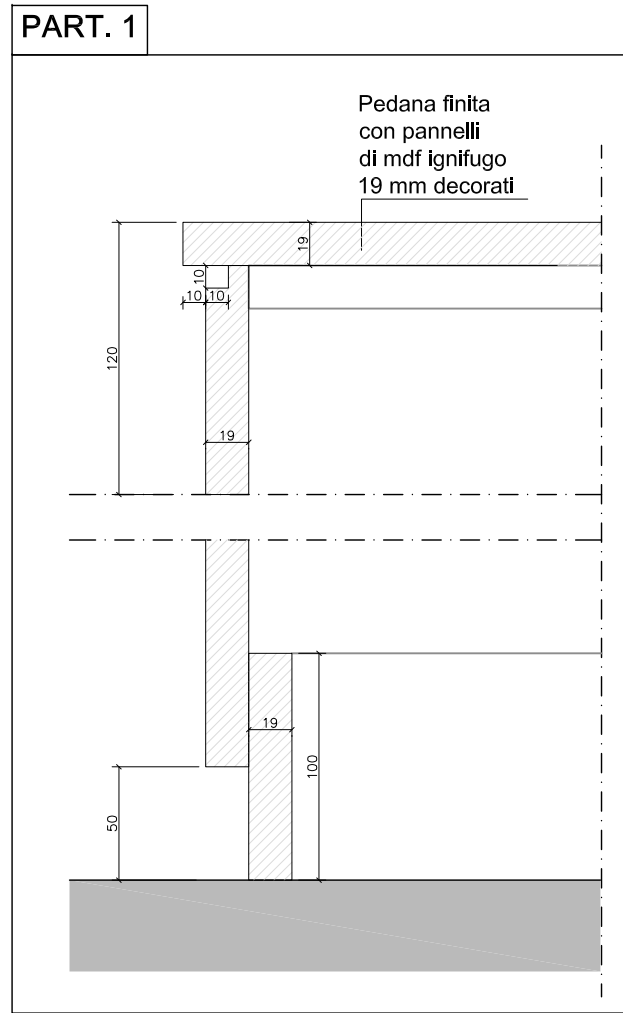

S10.S01
parete a specchio

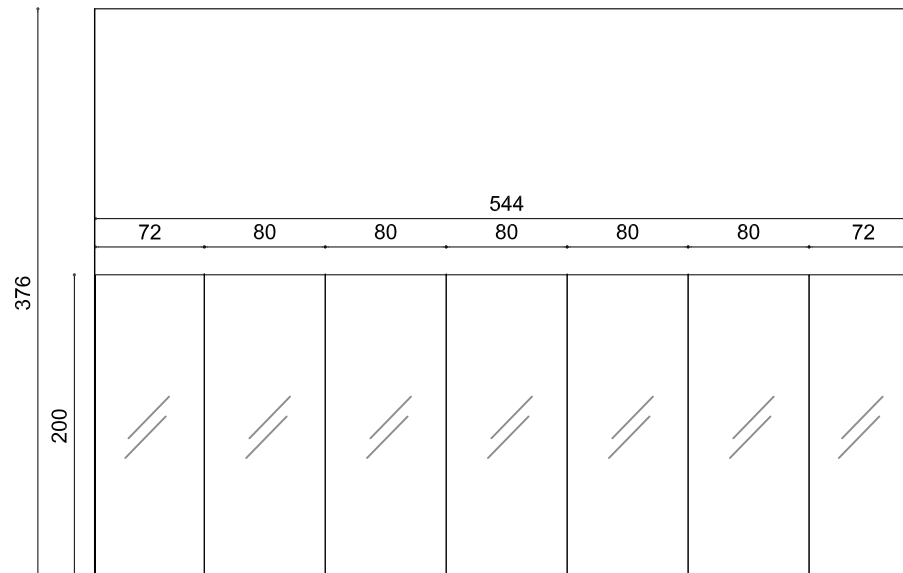

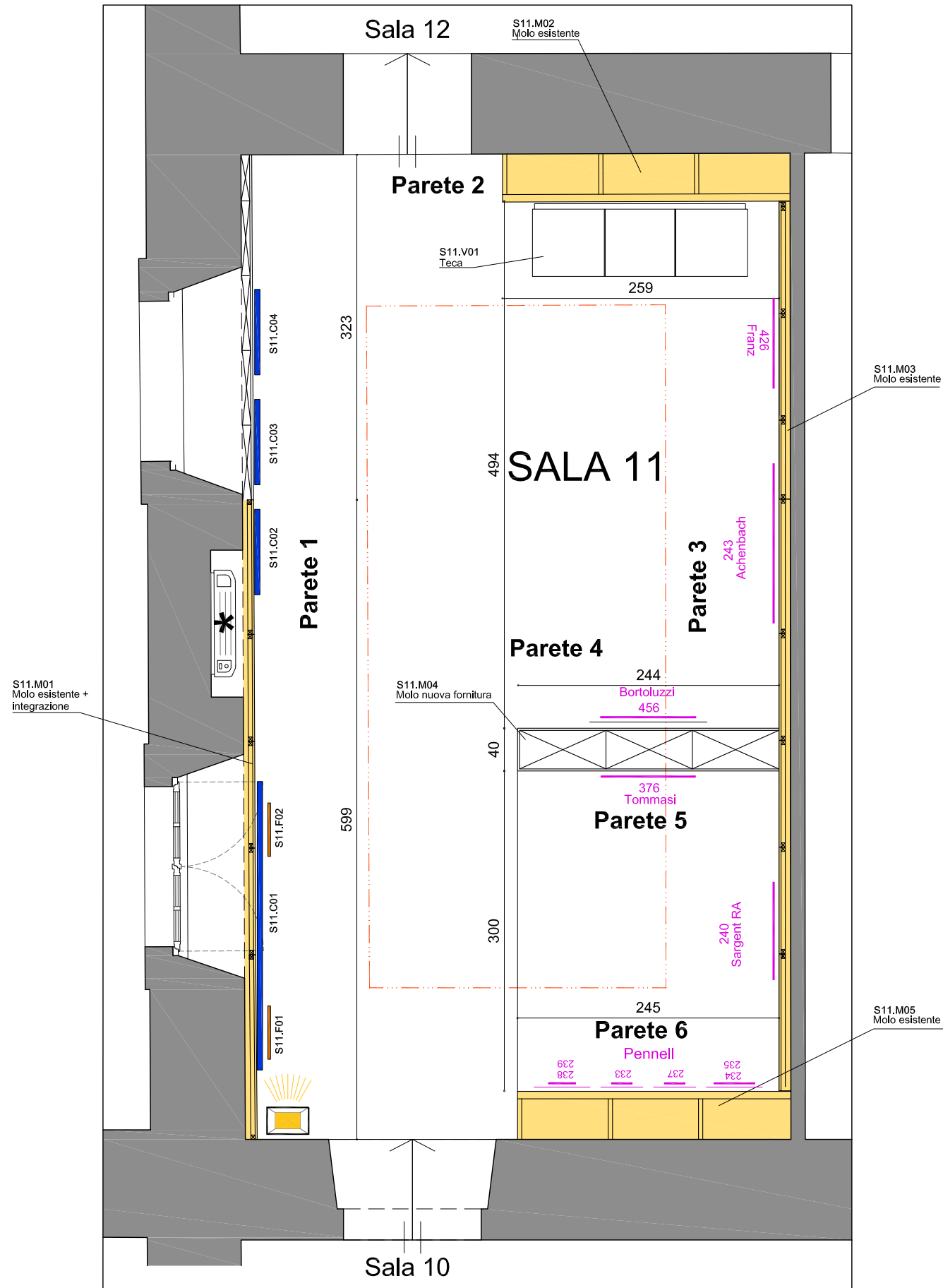

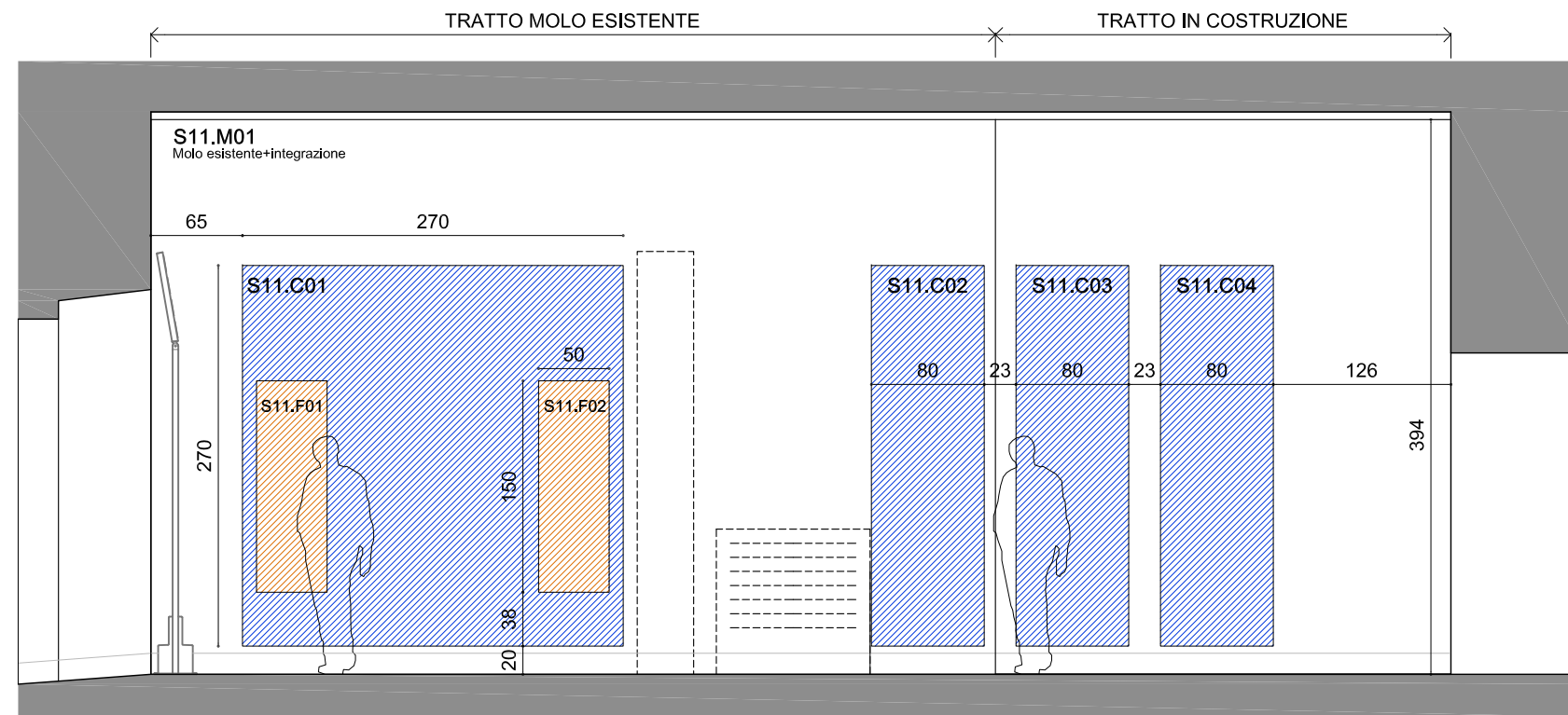

Parete 1

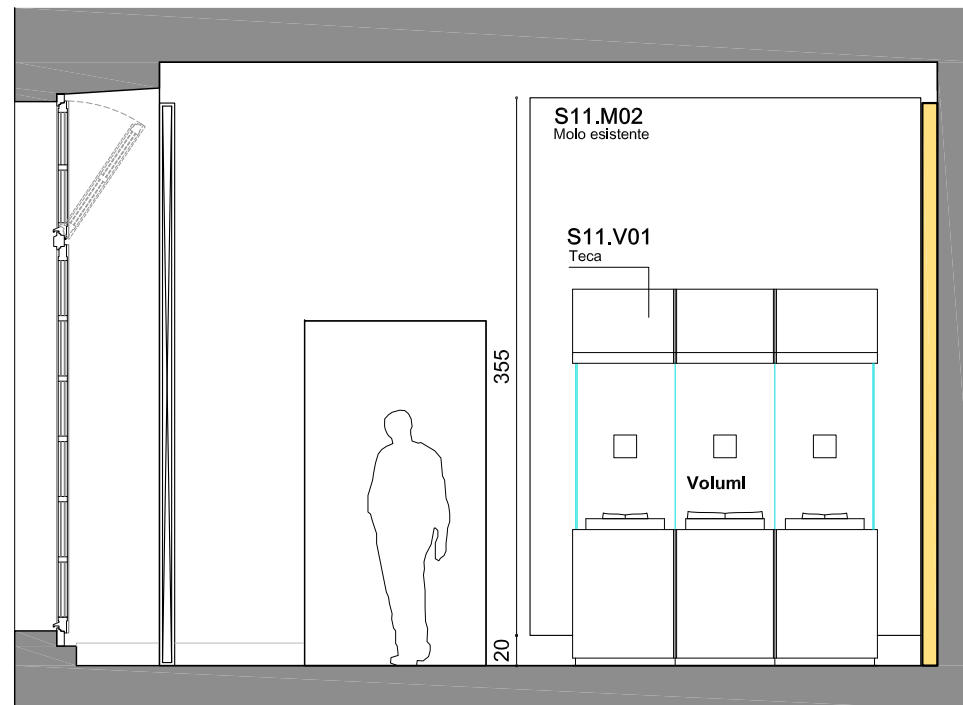

Parete 2

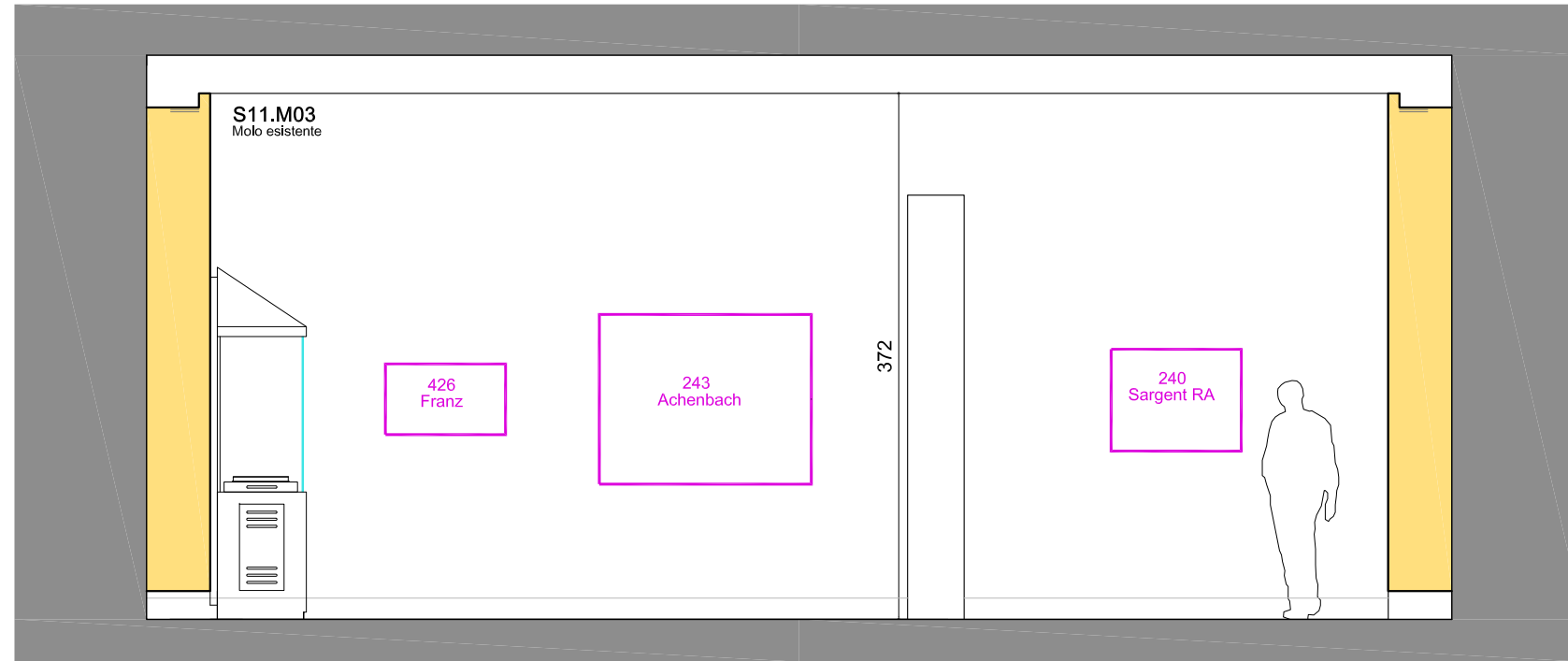

Parete 3



Parete 4



Parete 5

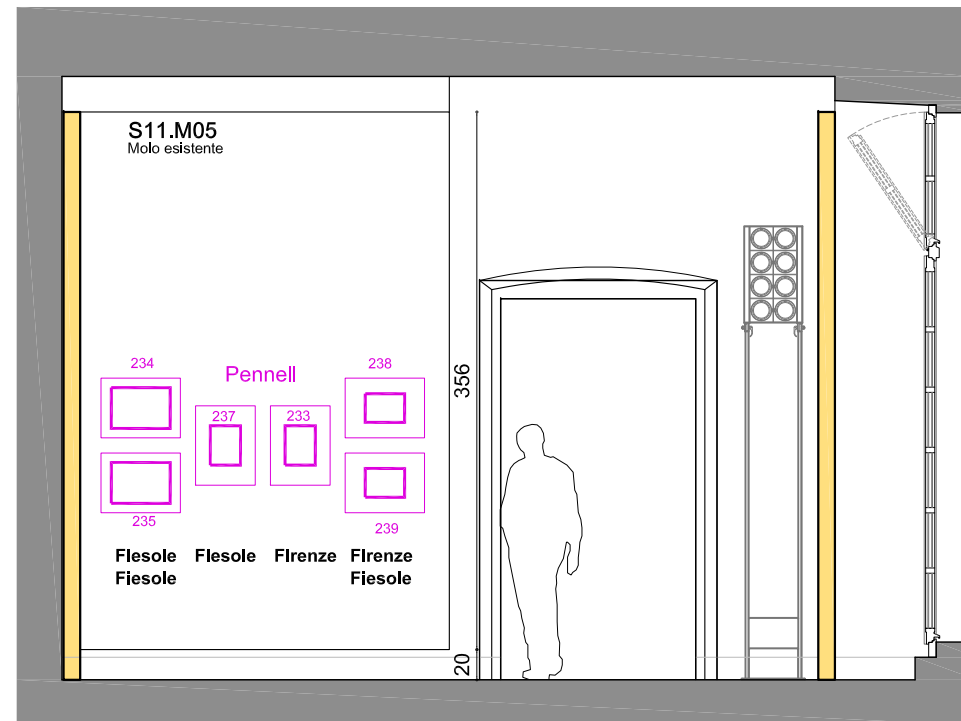

Parete 6

PIANTA C

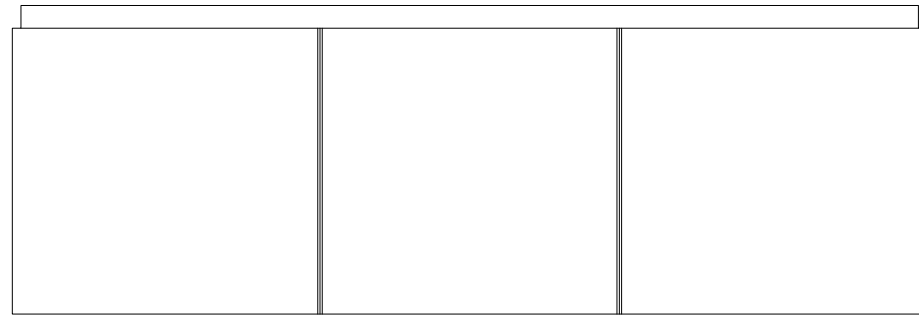

PIANTA B

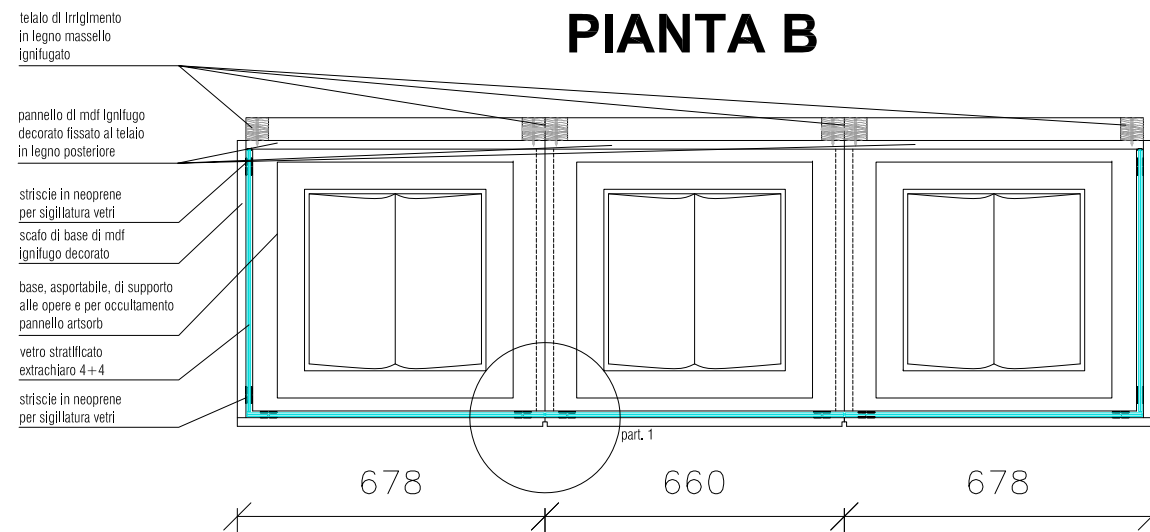

PIANTA A

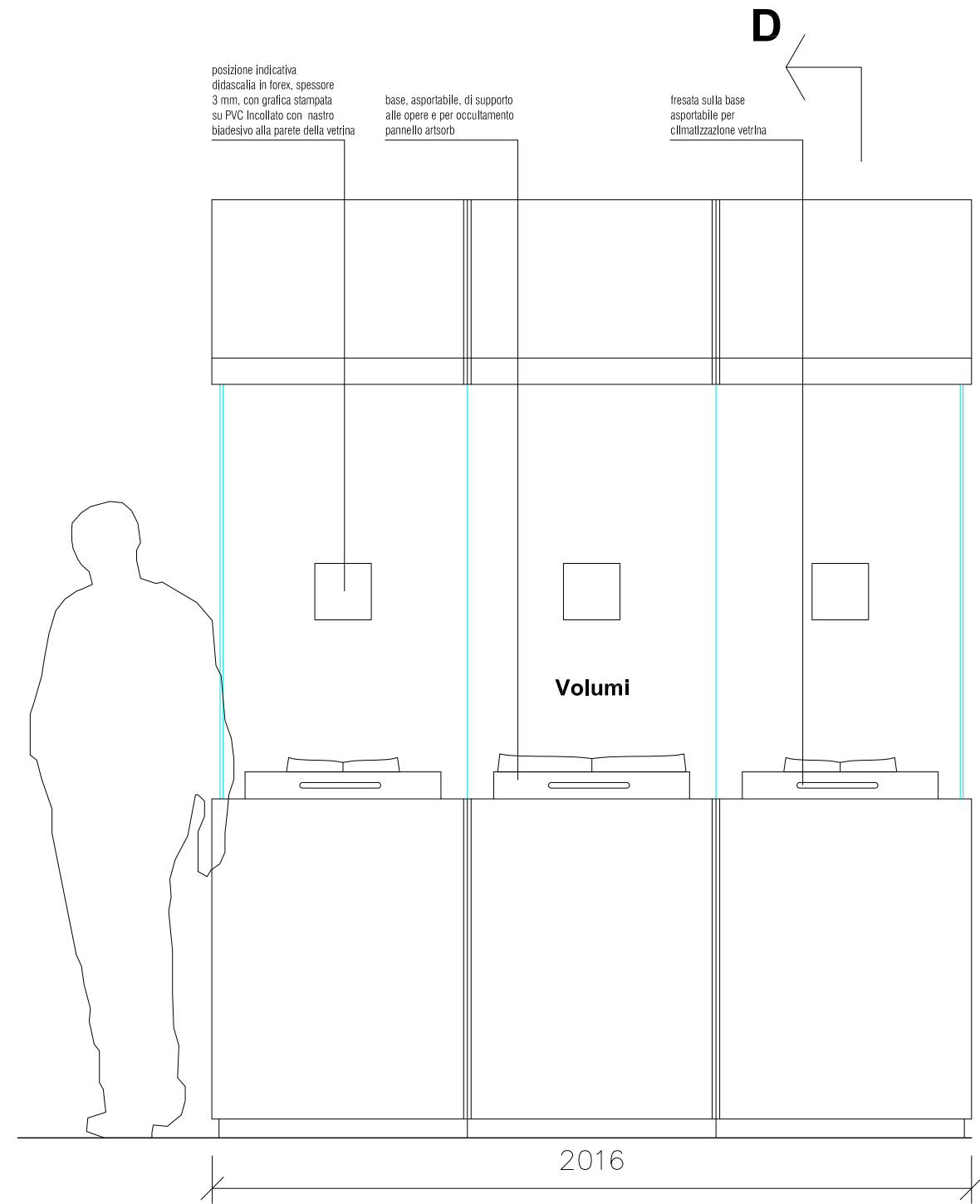
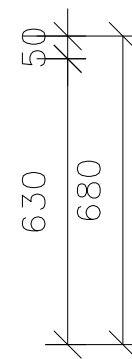
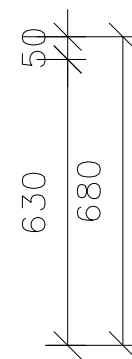
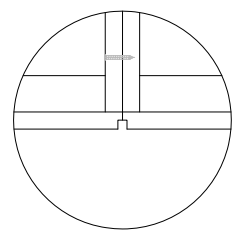
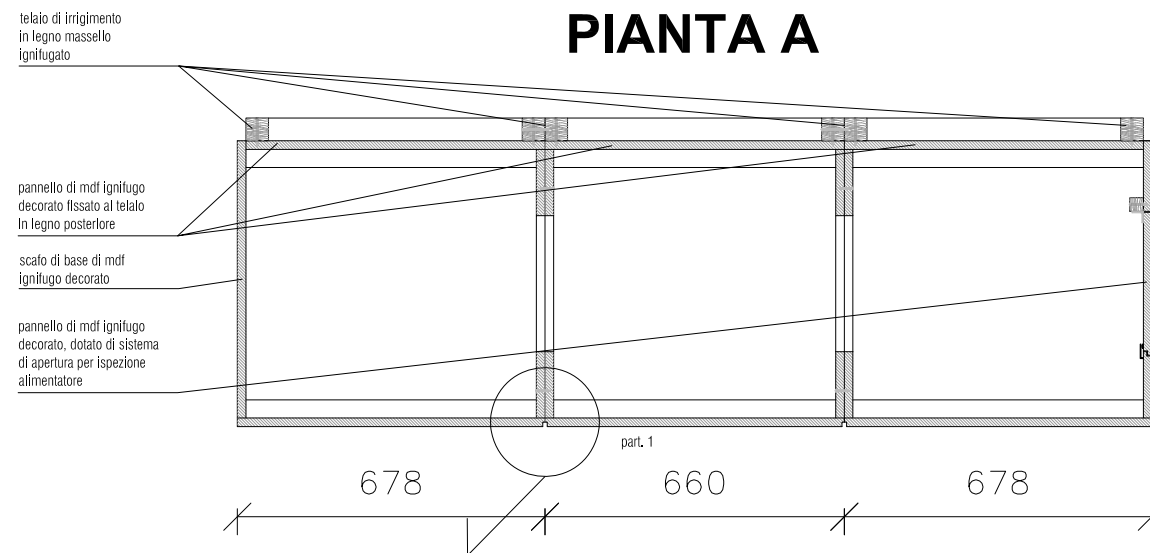

PROSPETTO FRONTALE

S11.V01
Teca

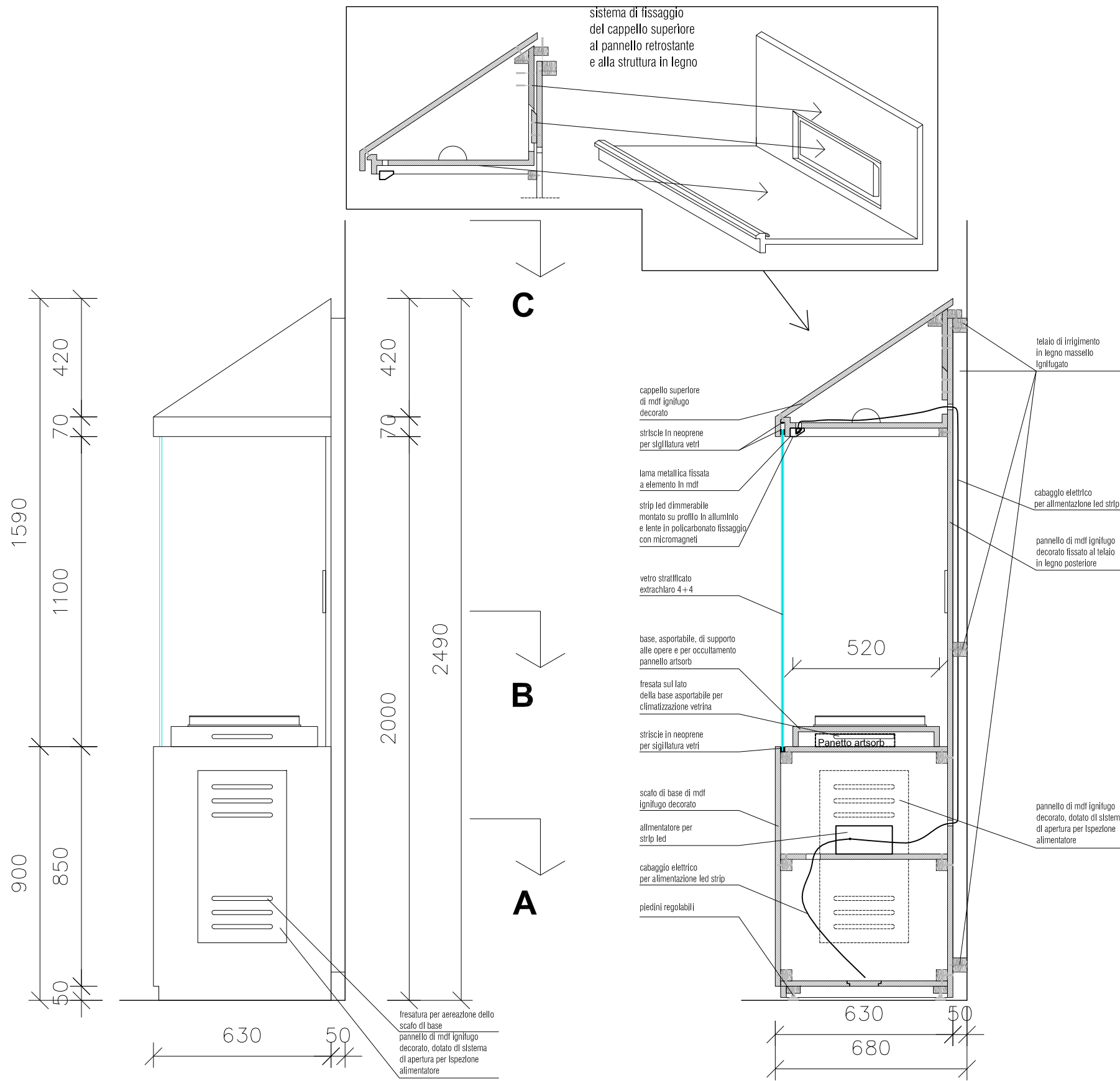

DETTAGLIO SIGILLATURA VETRI

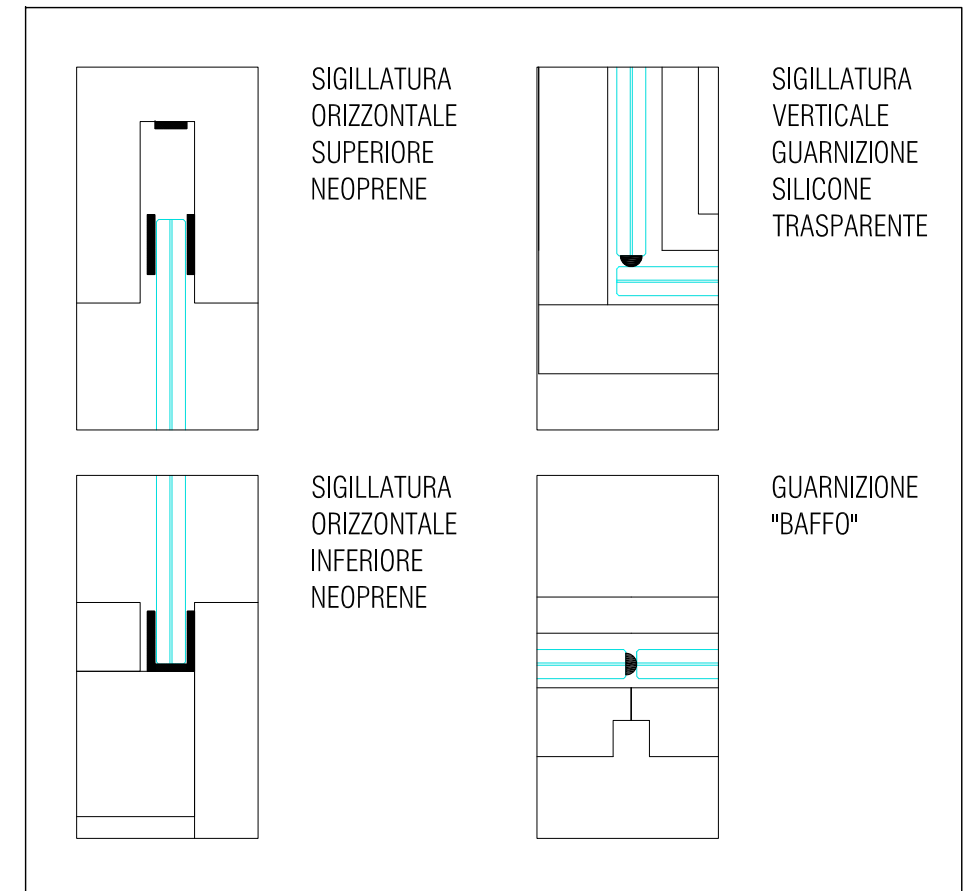

S11.V01
Teca

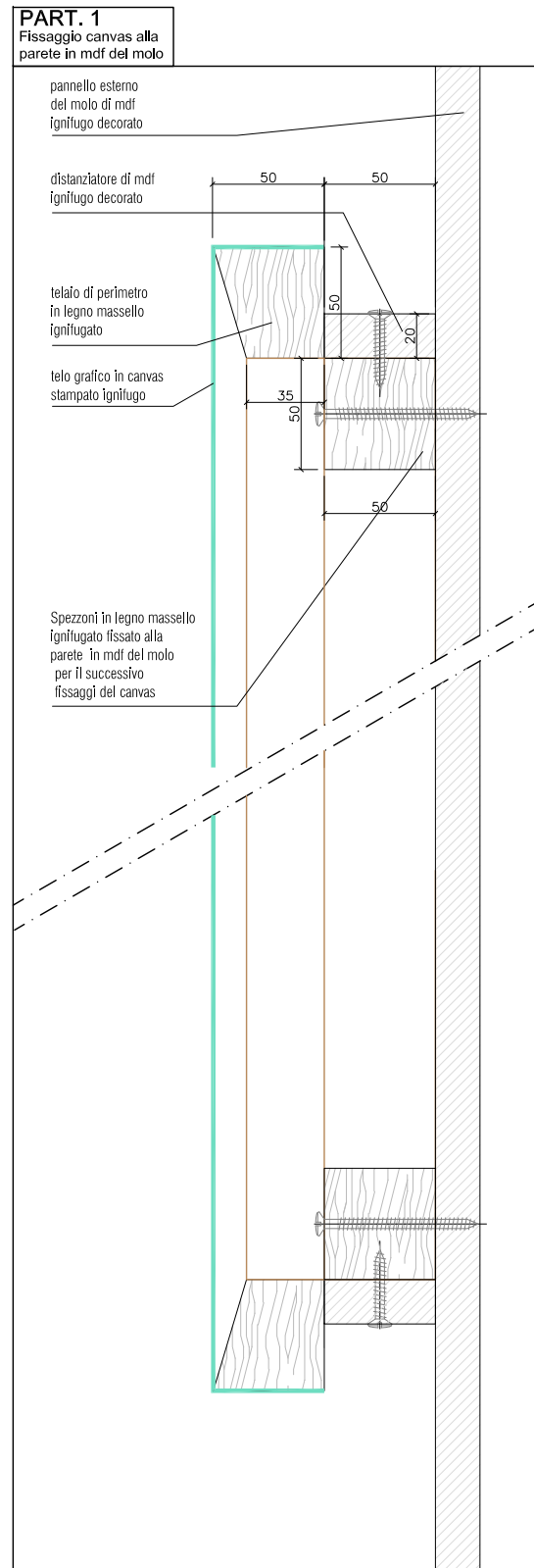
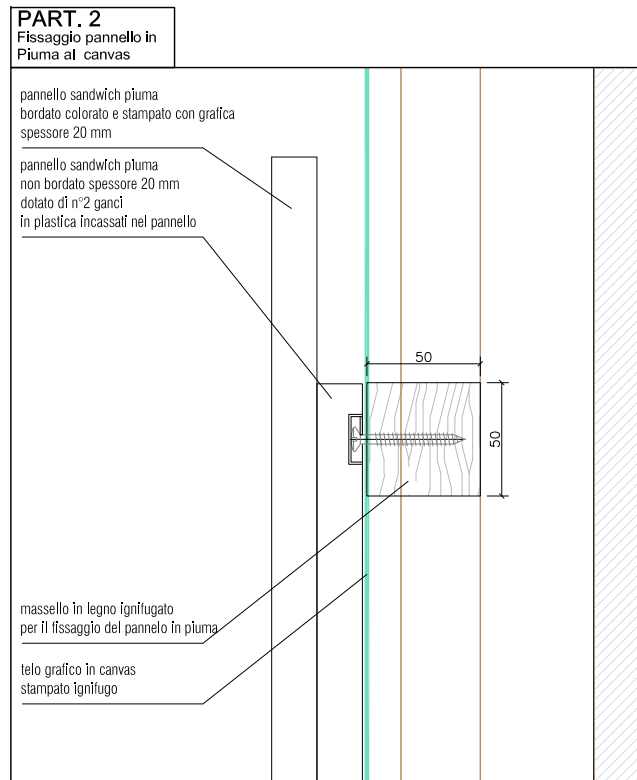

S11.C01
Telaio ligneo sparapuntato con telo grafico realizzato in masselli di legno ignifugato

S11.F01/F02
Doppio pannello in piuma spessore 20 mm

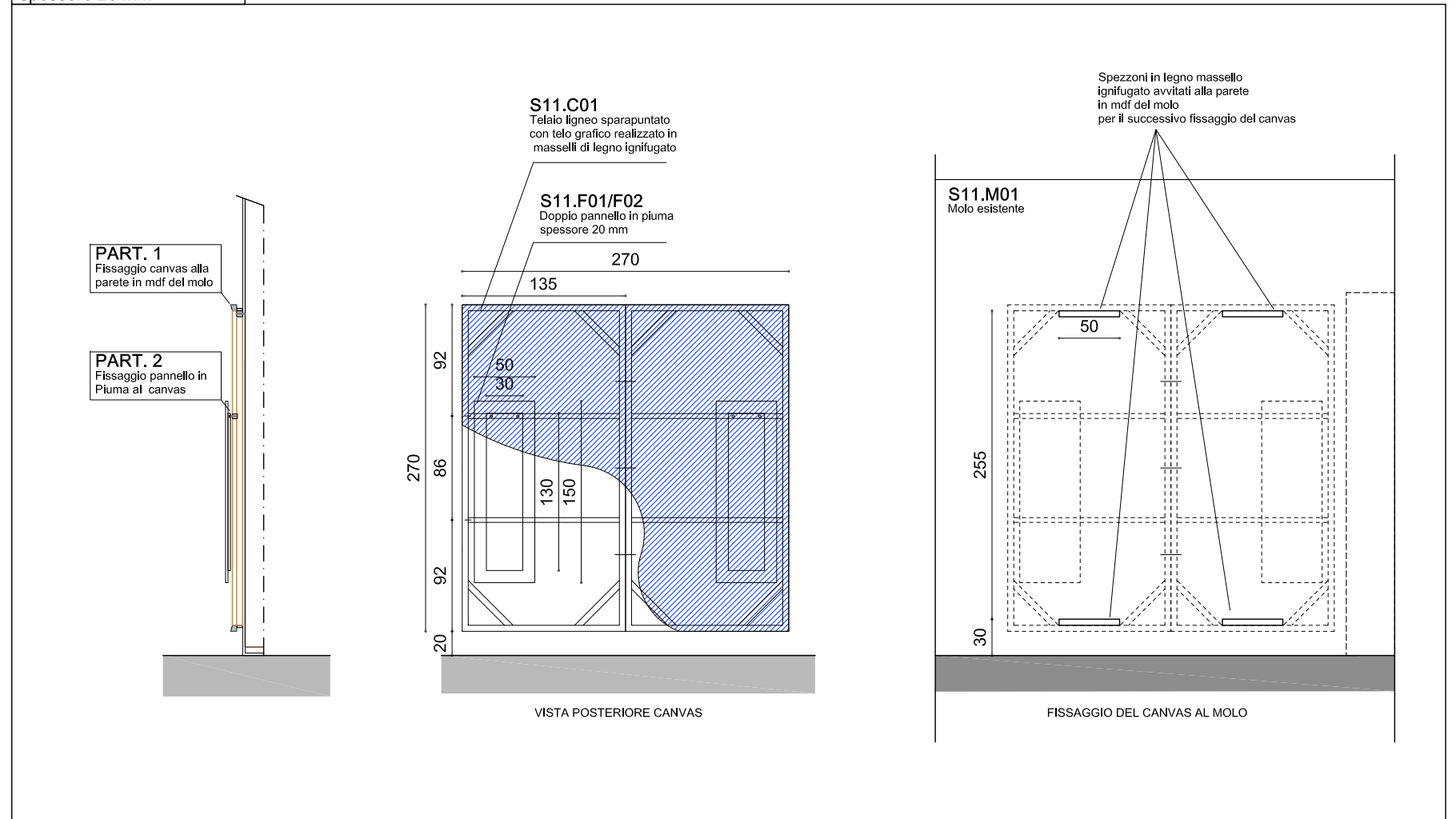

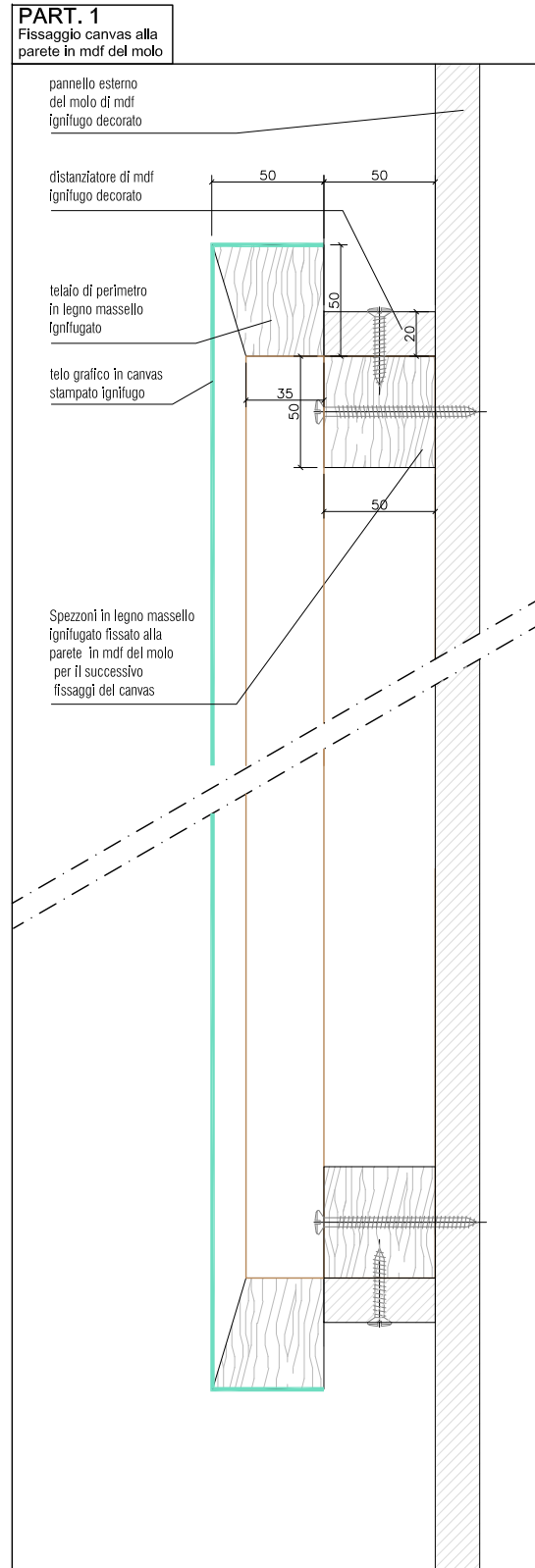

S11.C02/C03/C04
Telaio ligneo sparapuntato con telo grafico realizzato in masselli di legno ignifugato

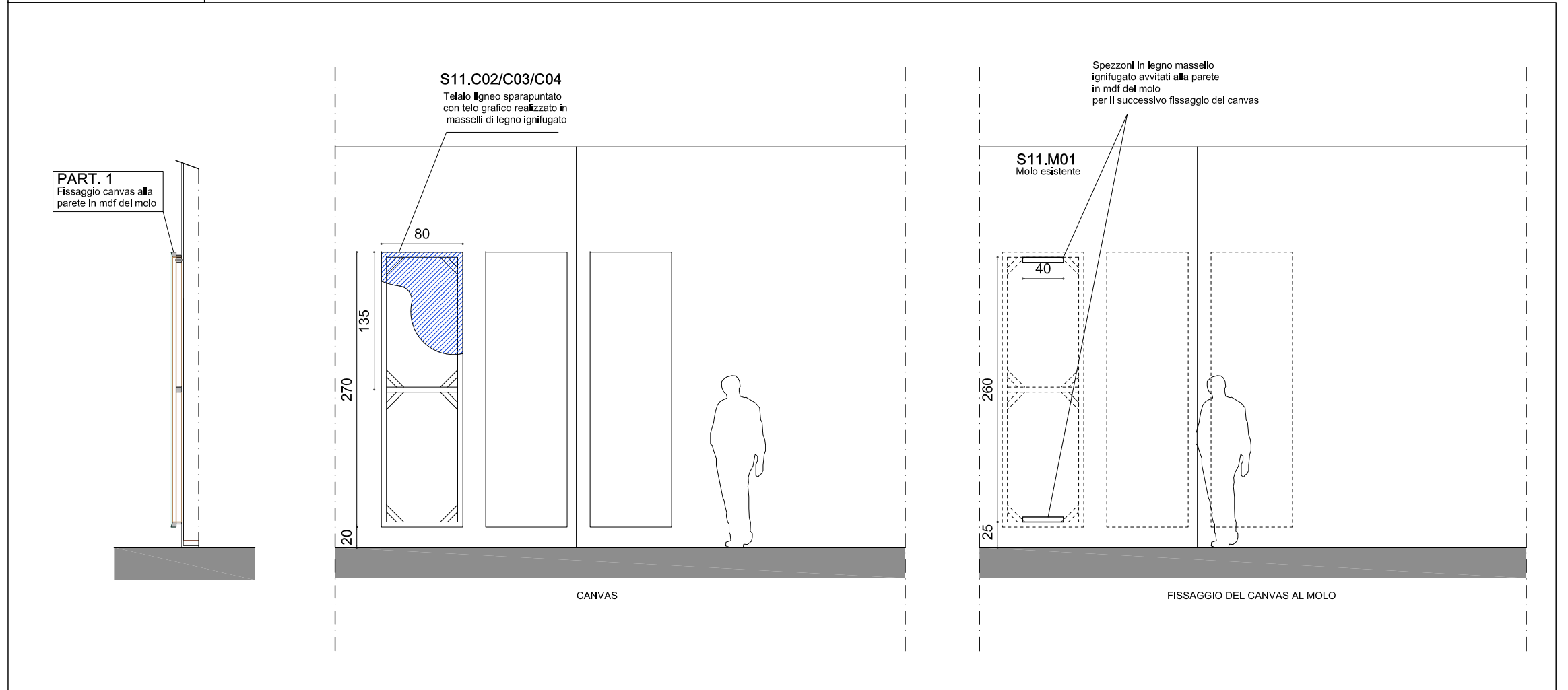

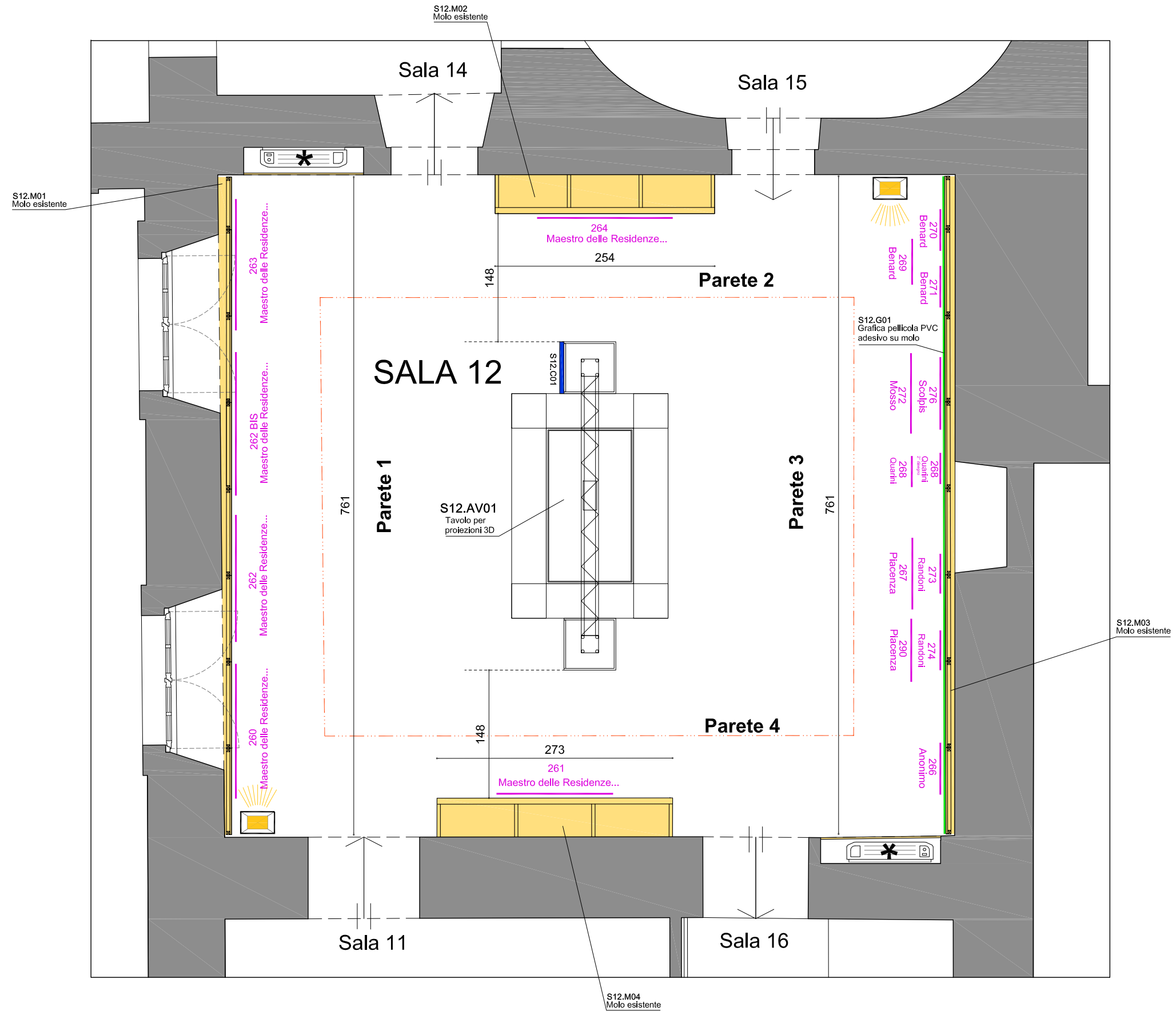

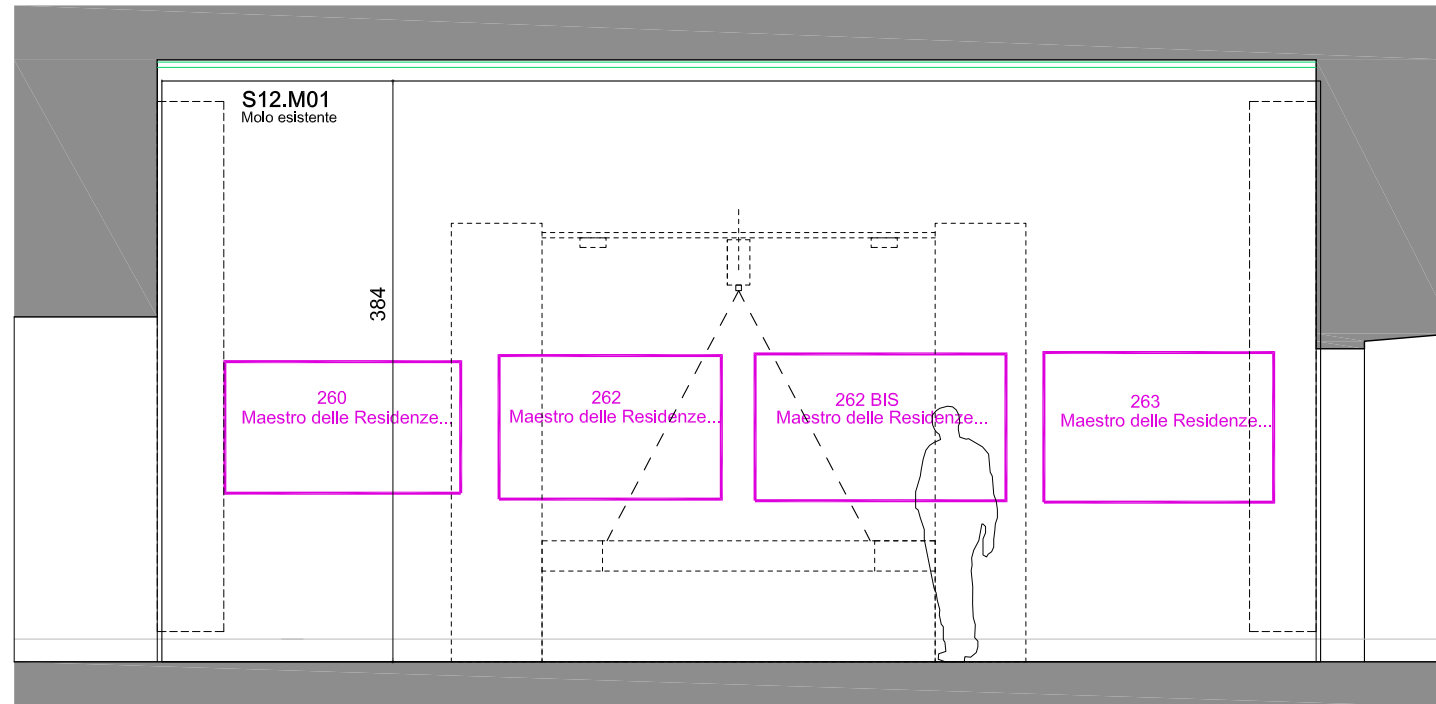

Parete 1

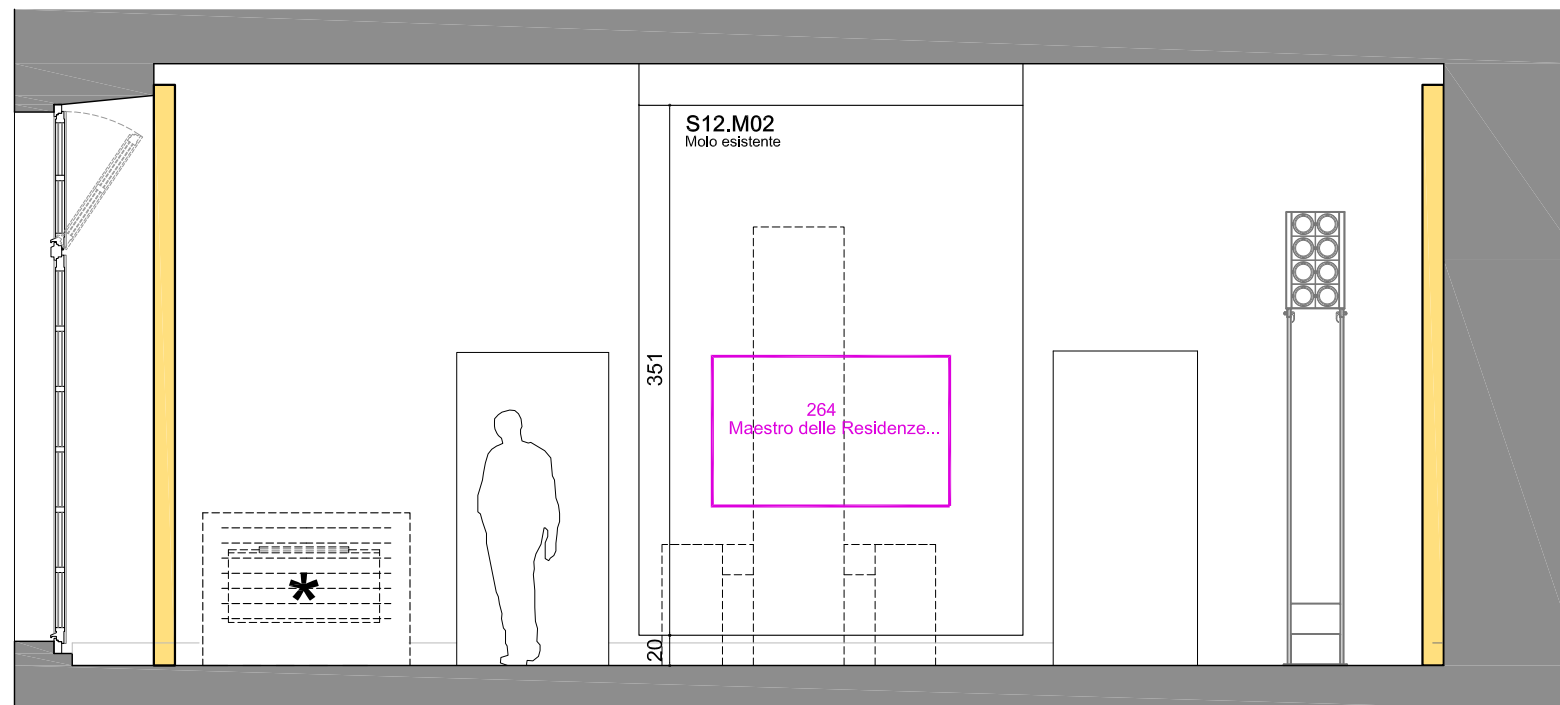

Parete 2

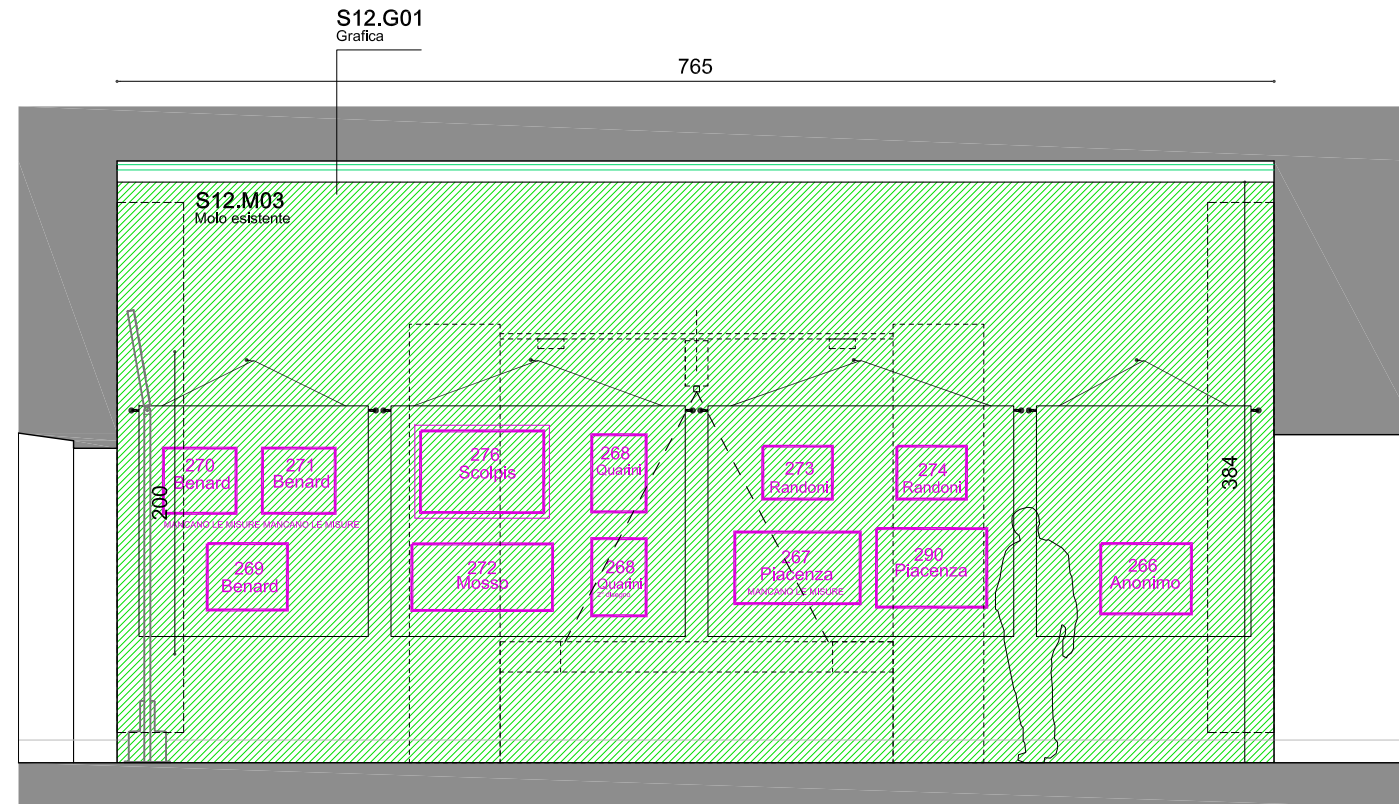

Parete 3

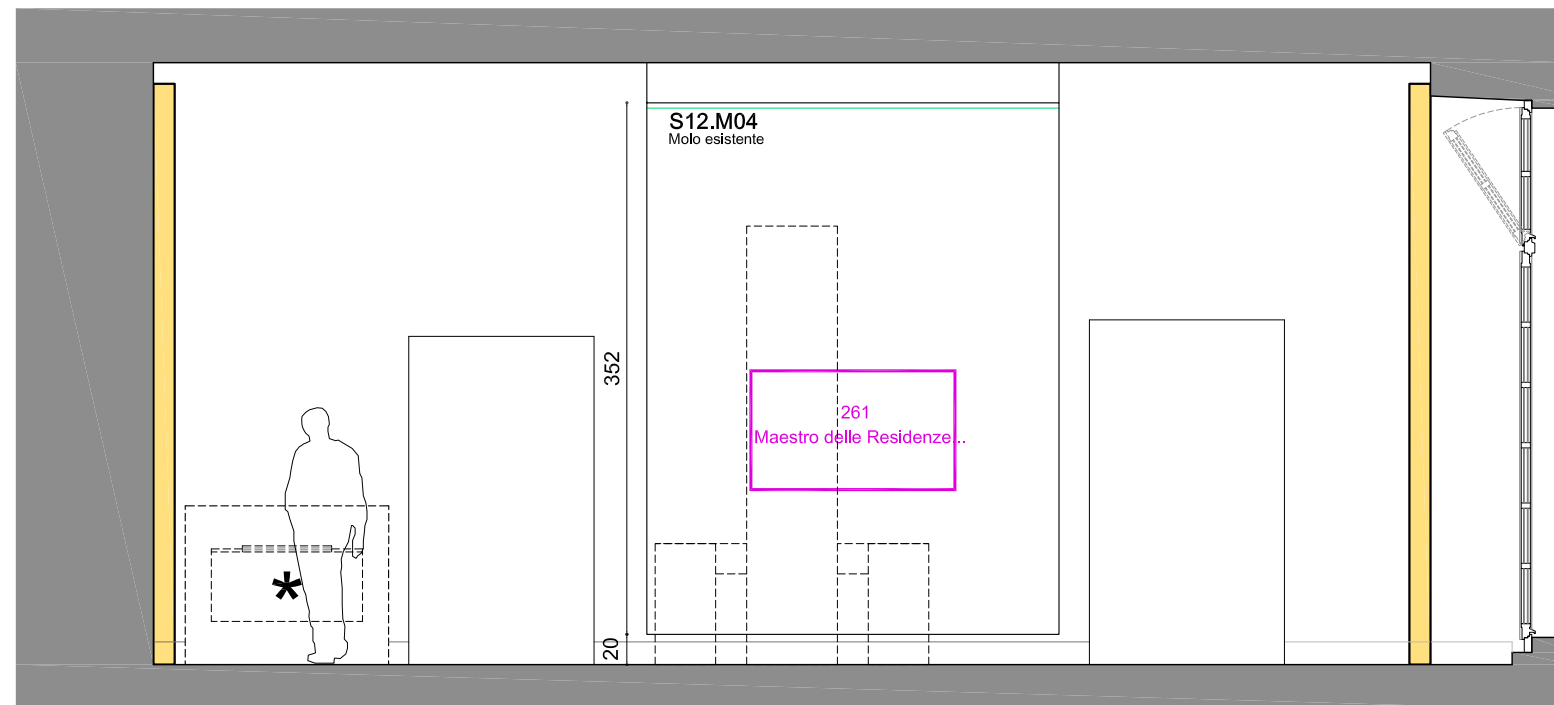

Parete 4

PART. 1
Fissaggio canvas alla parete in mdf del moio

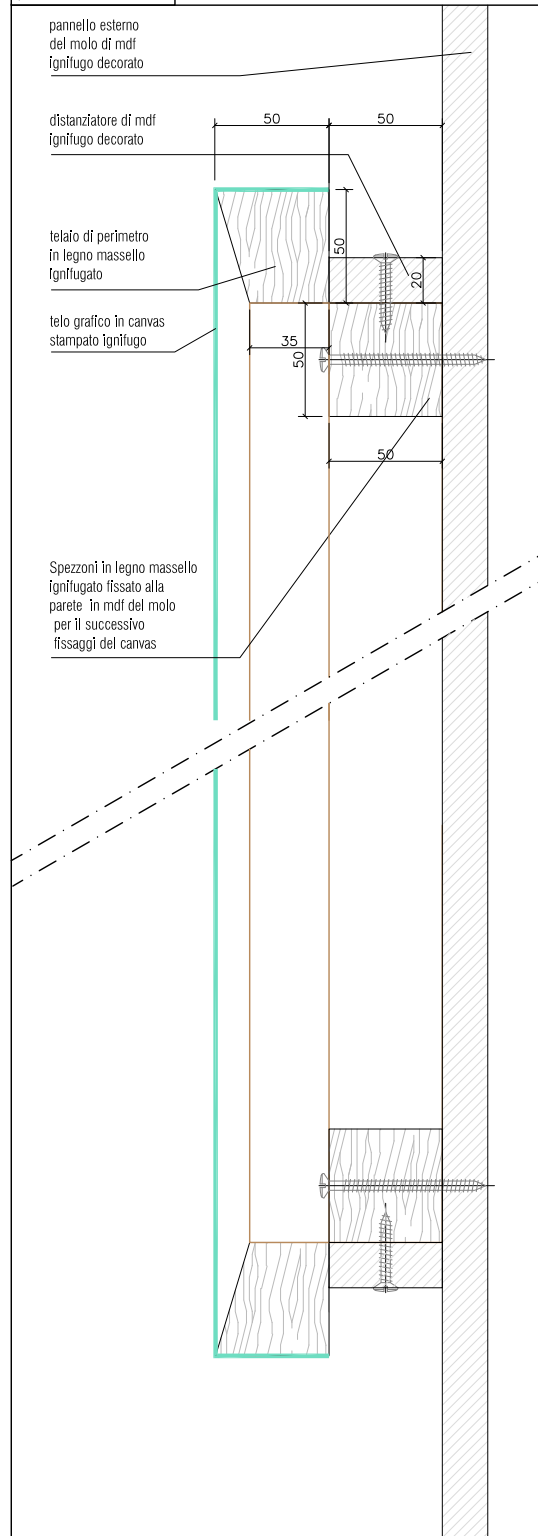

S12.C01
Telaio ligneo sparapuntato con telo grafico realizzato in masselli di legno ignifugato

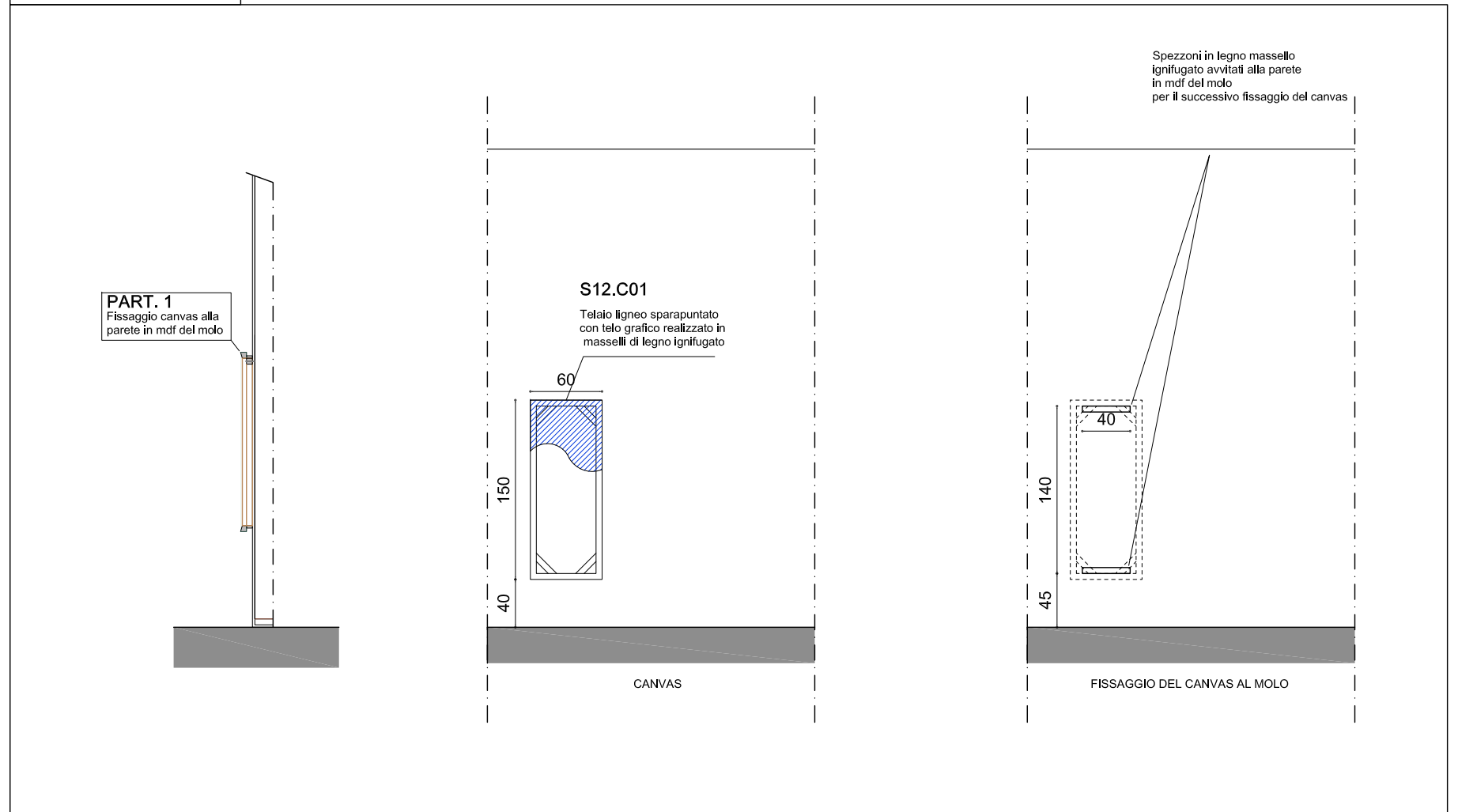

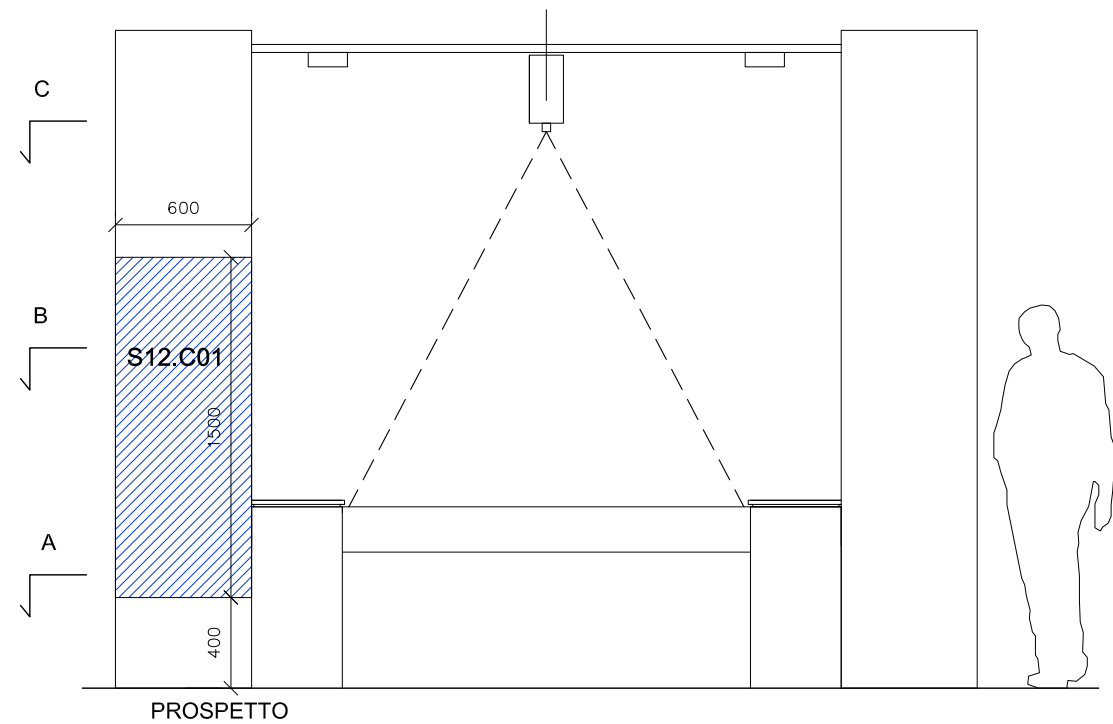
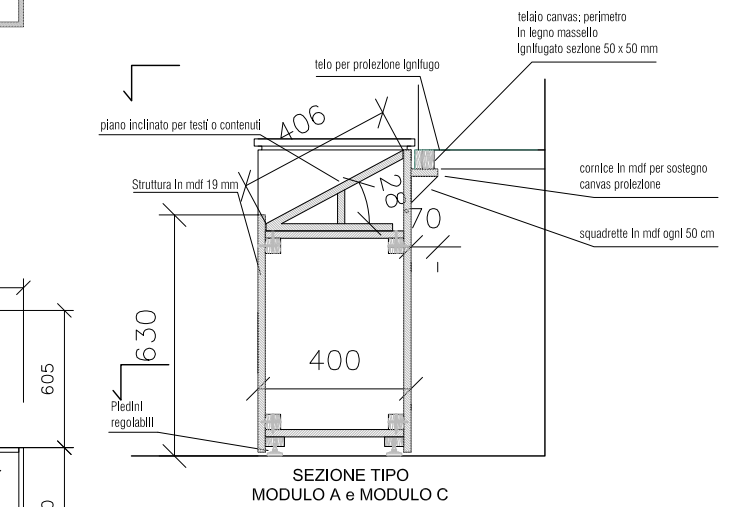
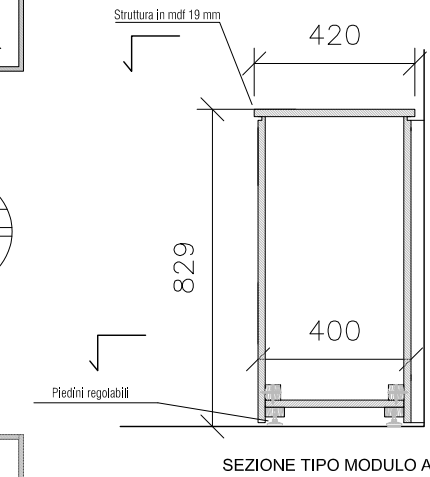
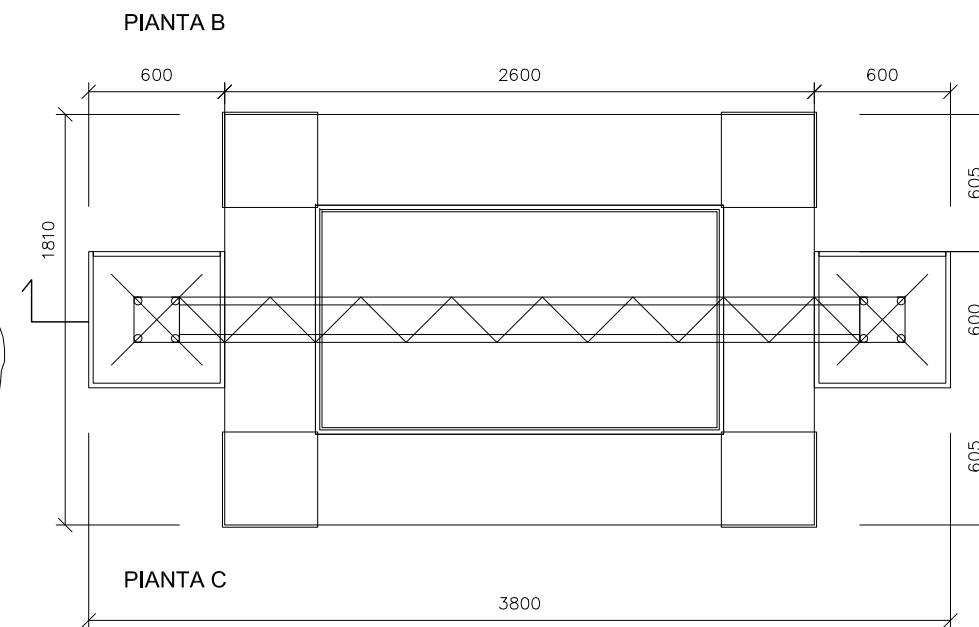
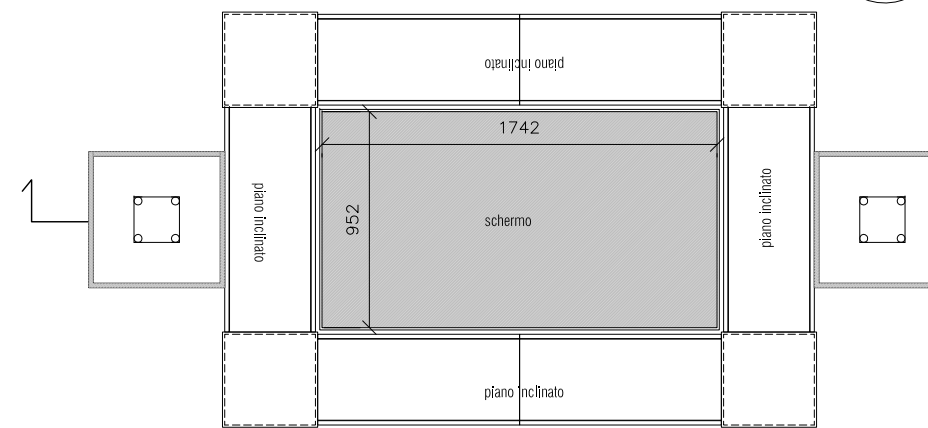
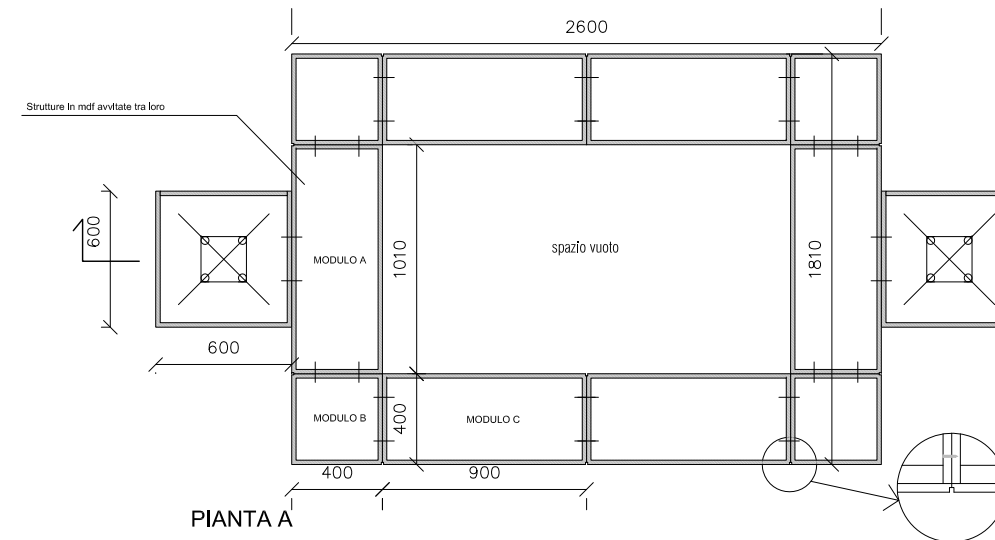
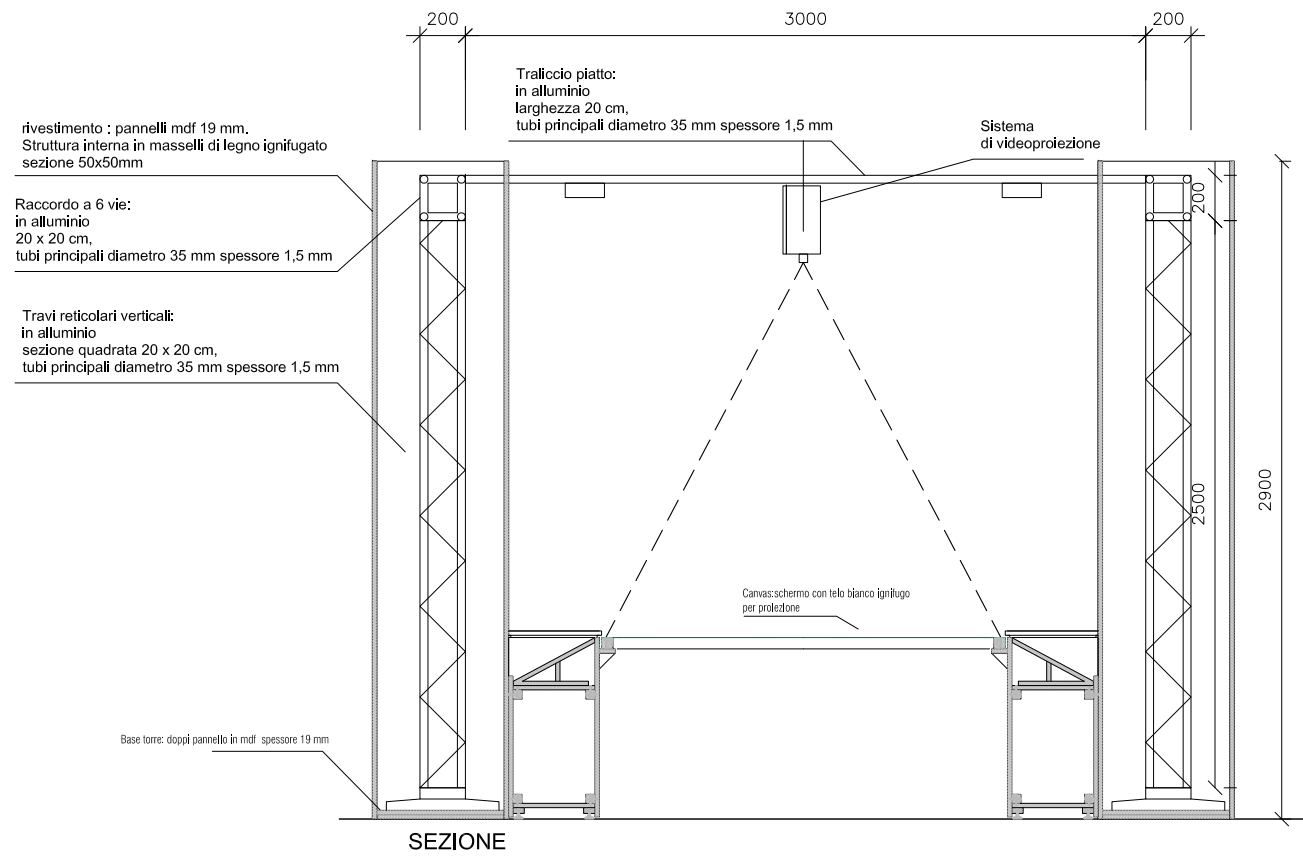

S12.AV01
Tavolo per proiezioni 3D

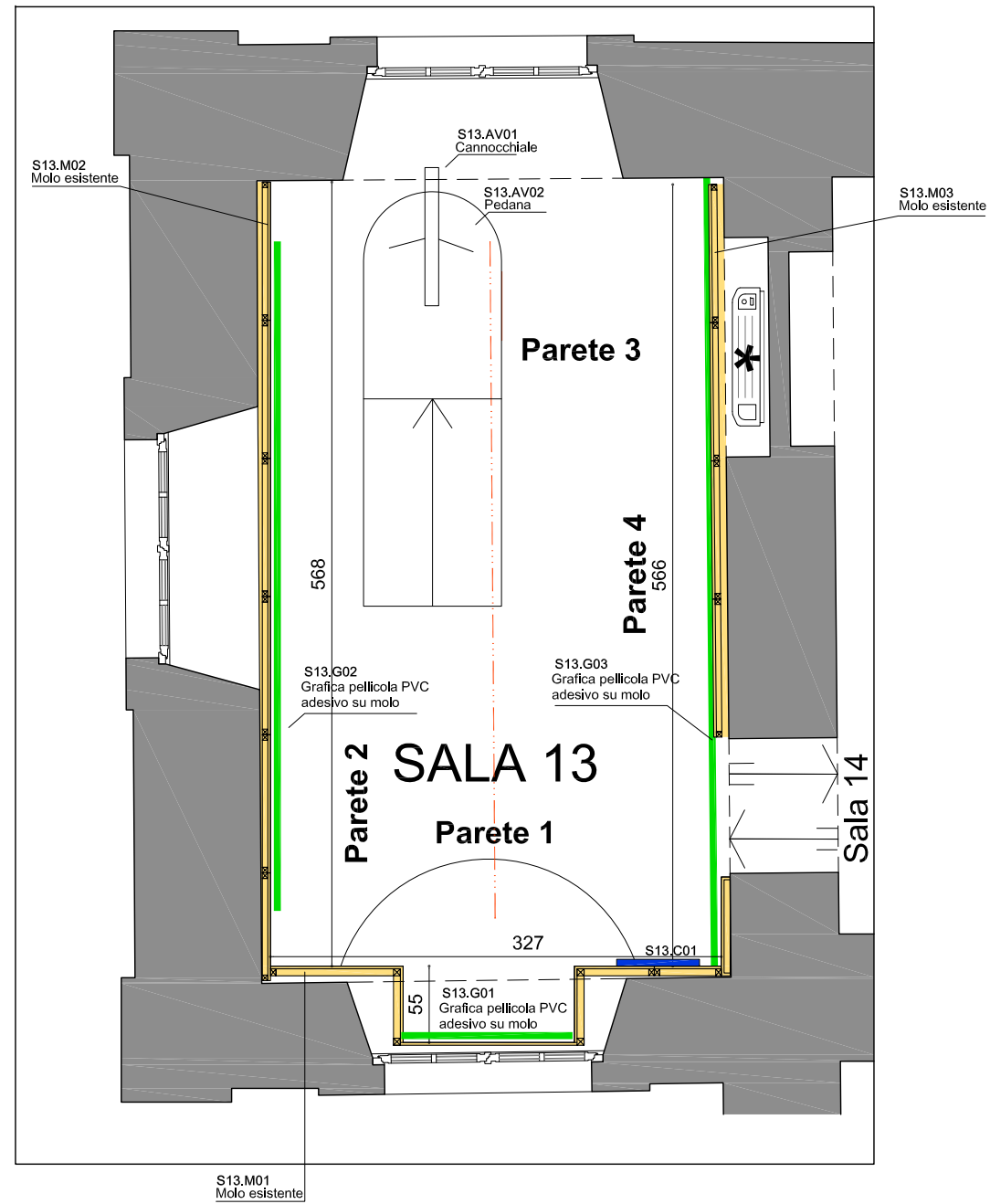

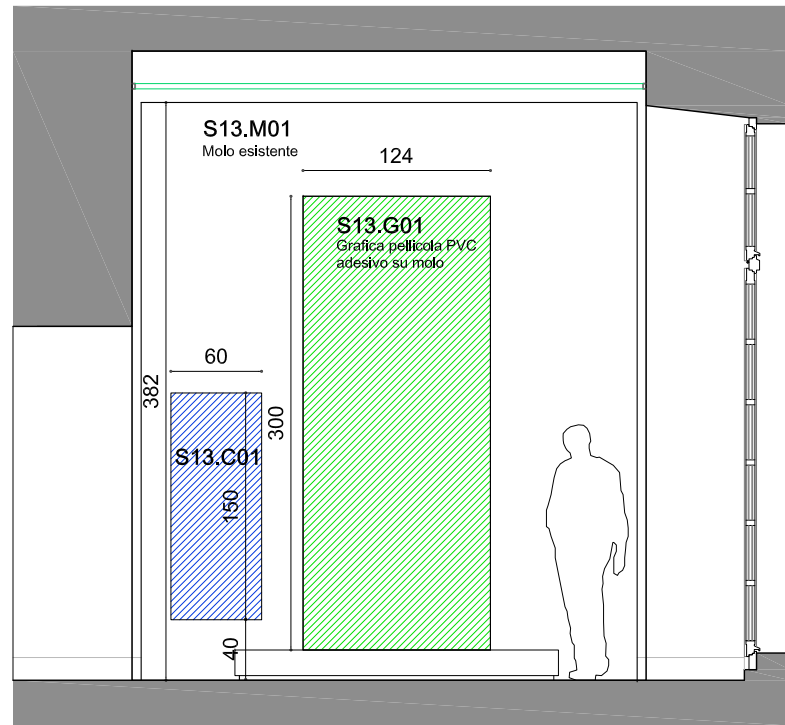

Parete 1



Parete 3

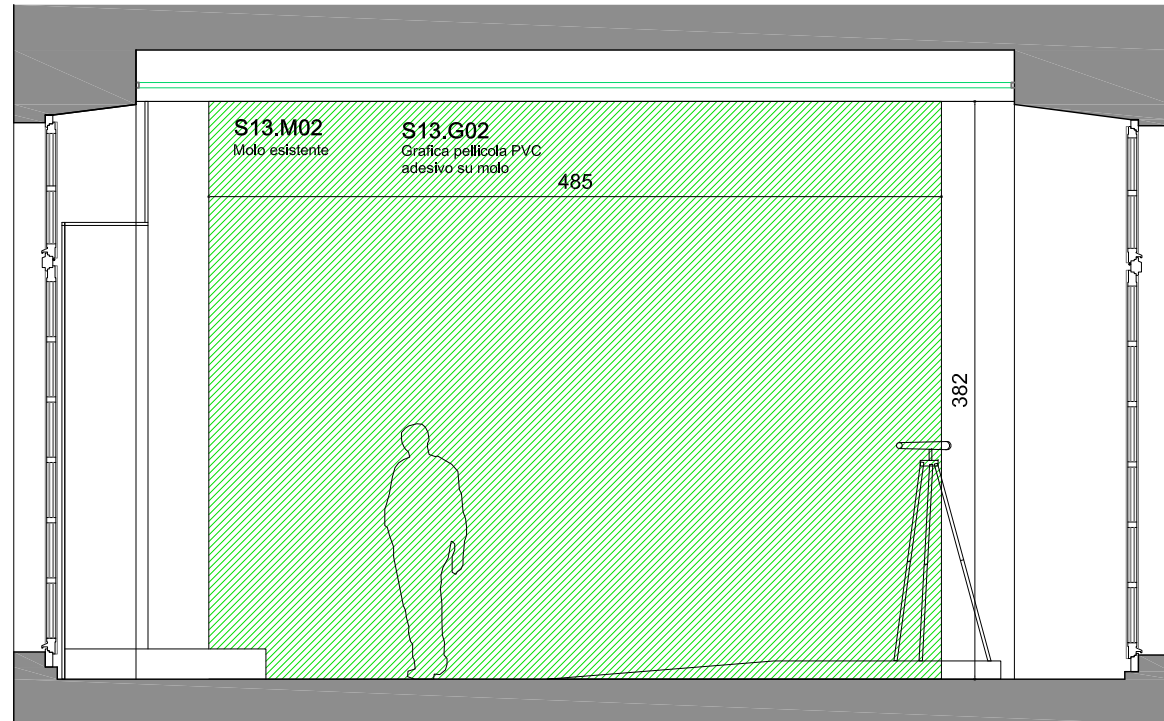

Parete 2

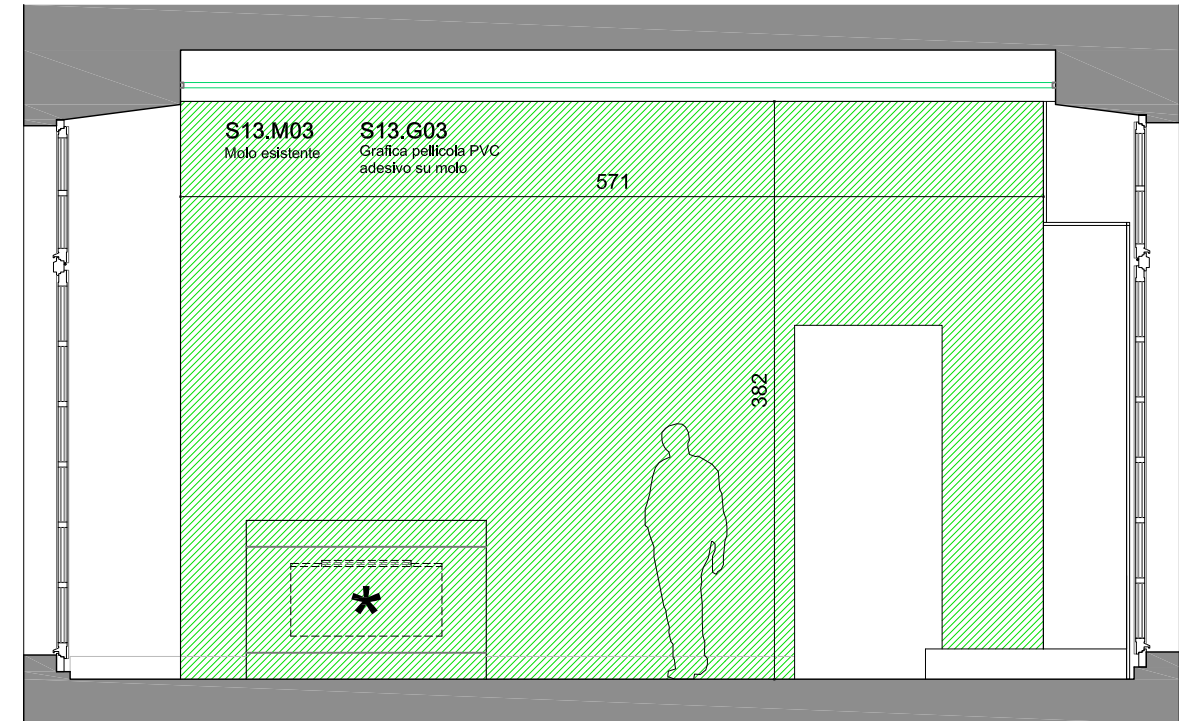

Parete 4

PART. 1
Fissaggio canvas alla parete in mdf del mofo

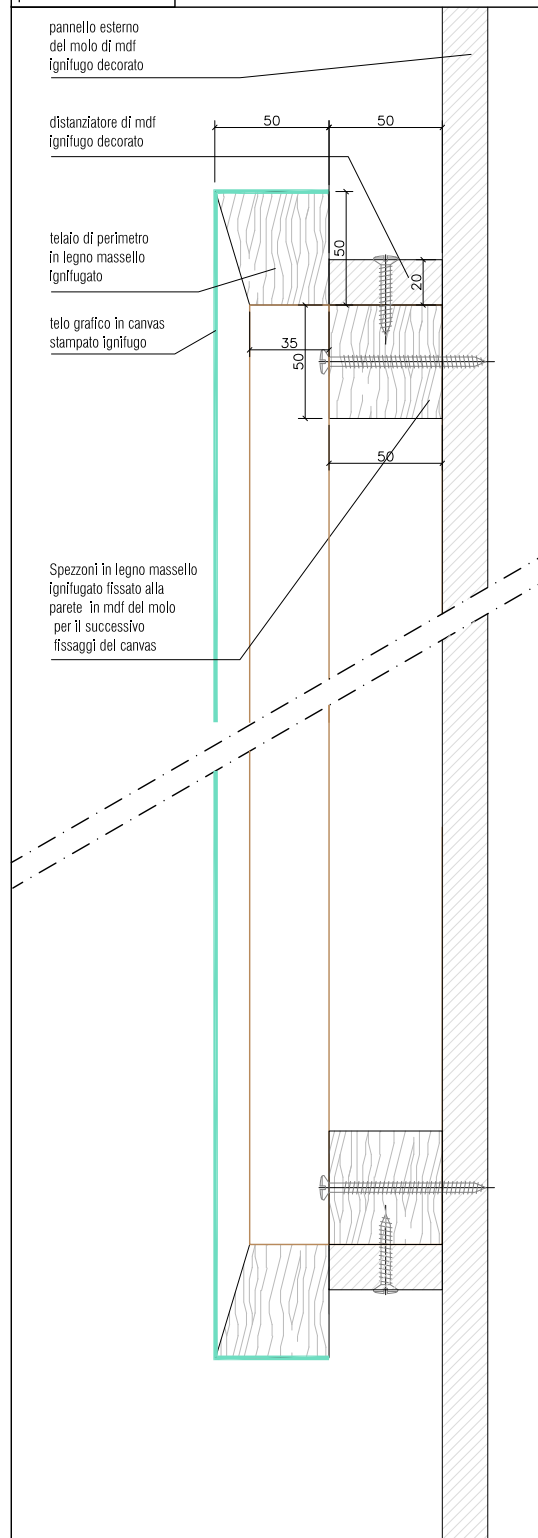

S13.C01
Telaio ligneo sparapuntato con telo grafico realizzato in masselli di legno ignifugato

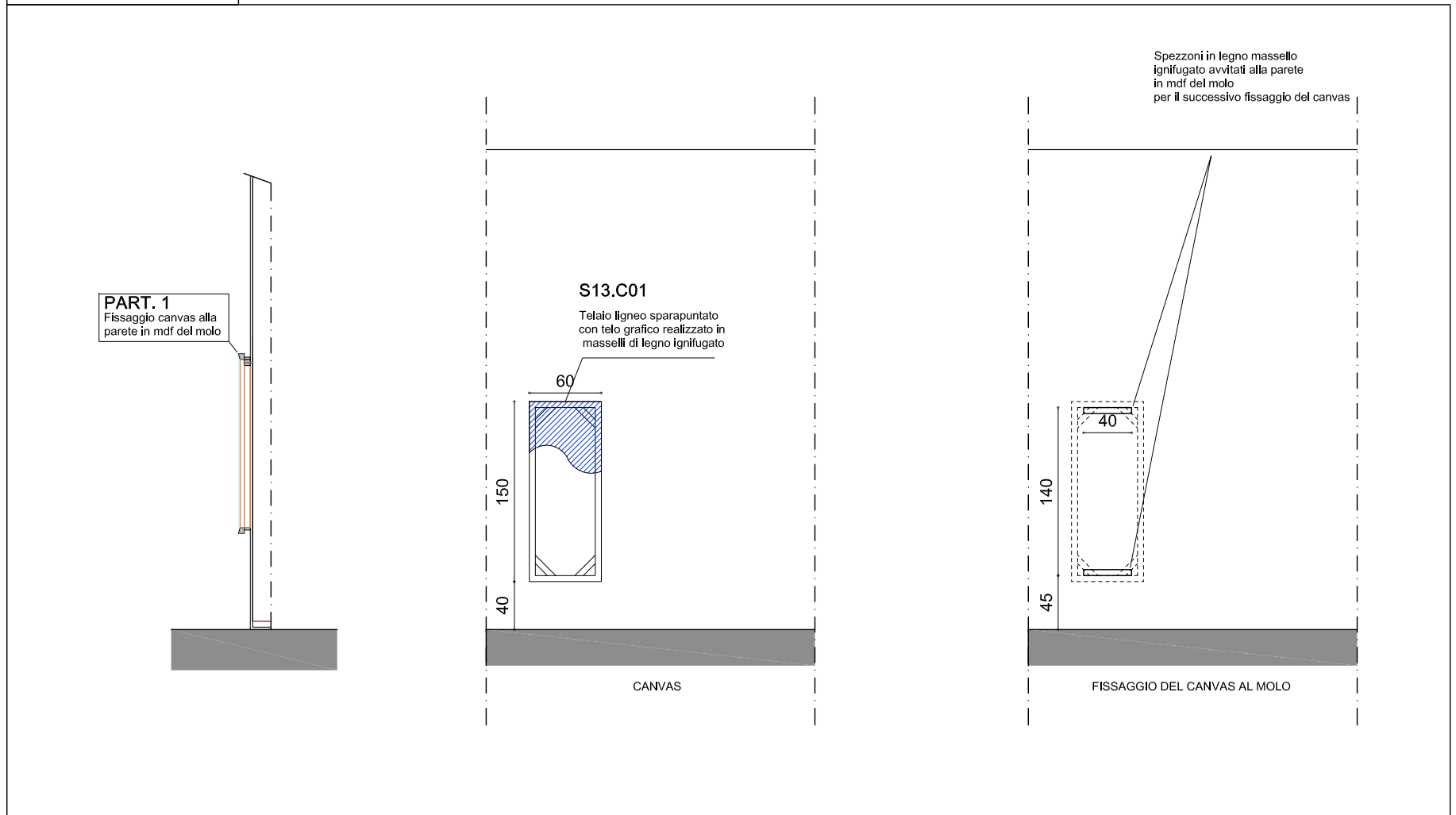

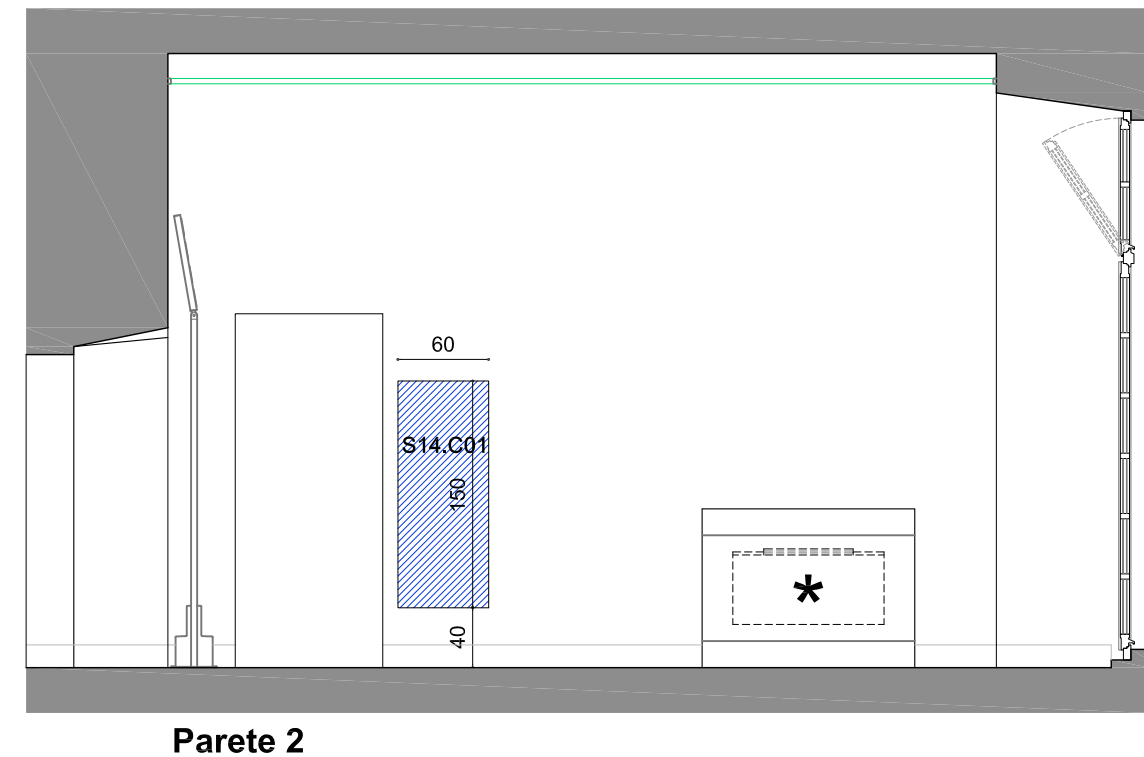
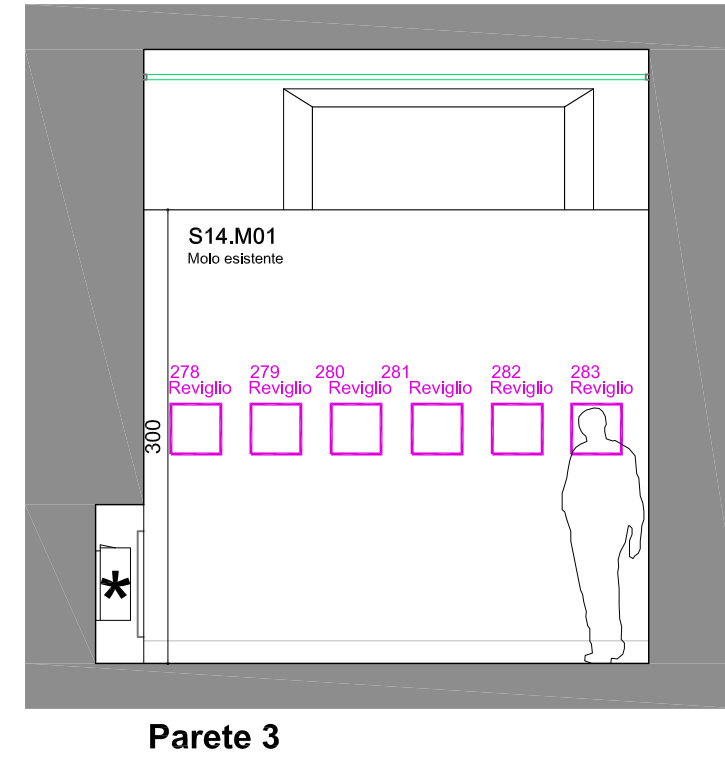

PART. 1
Fissaggio canvas alla parete in mdf del moio

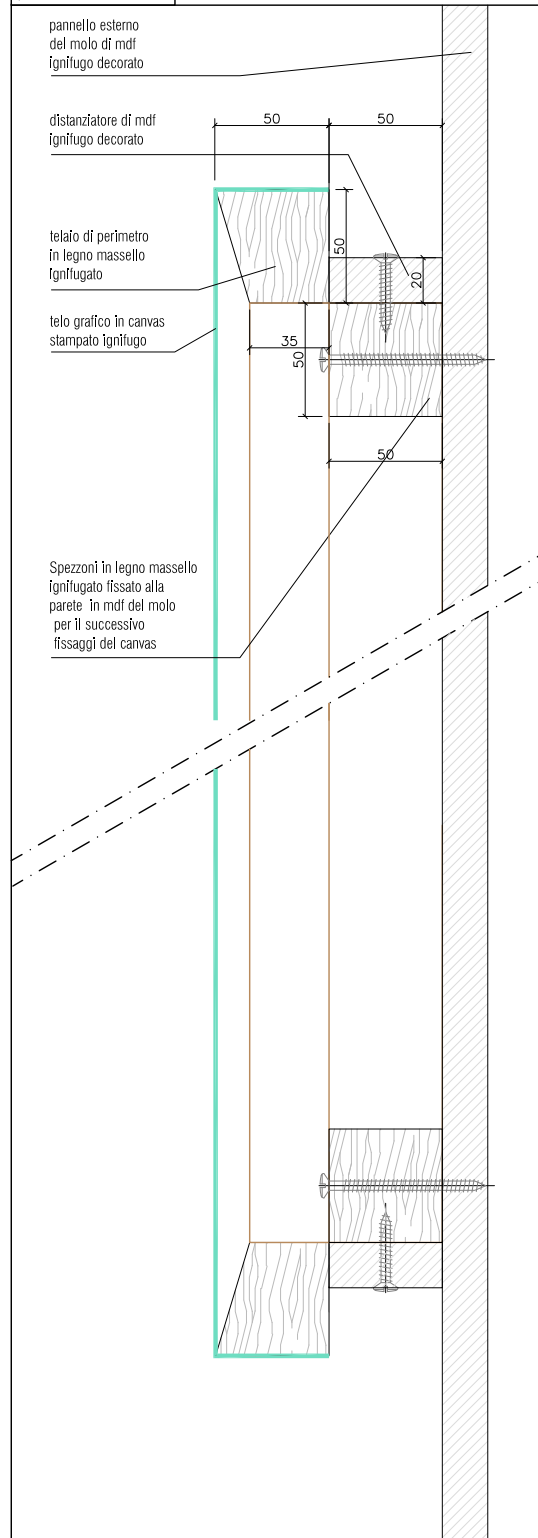

S14.C01
Telaio ligneo sparapuntato con telo grafico realizzato in masselli di legno ignifugato

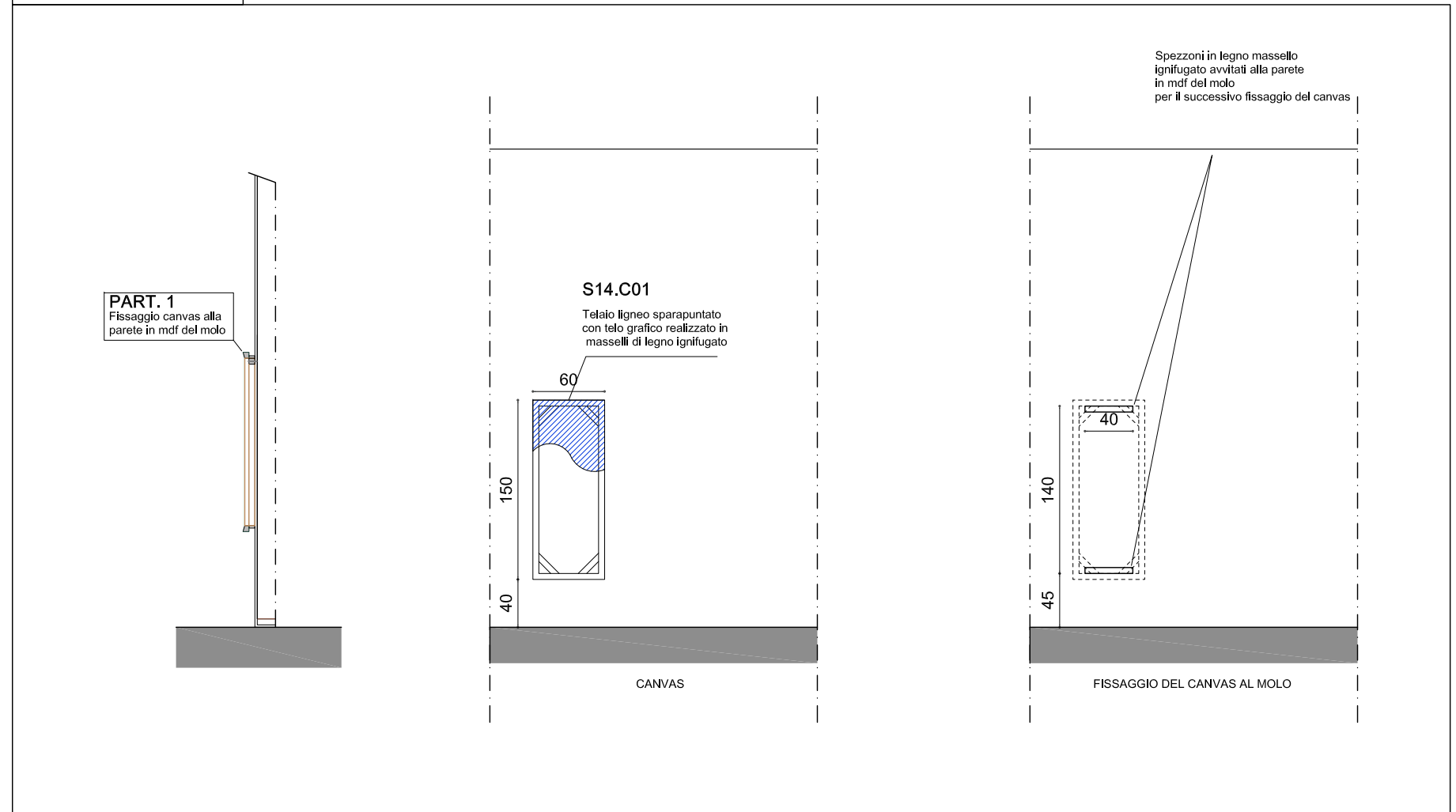

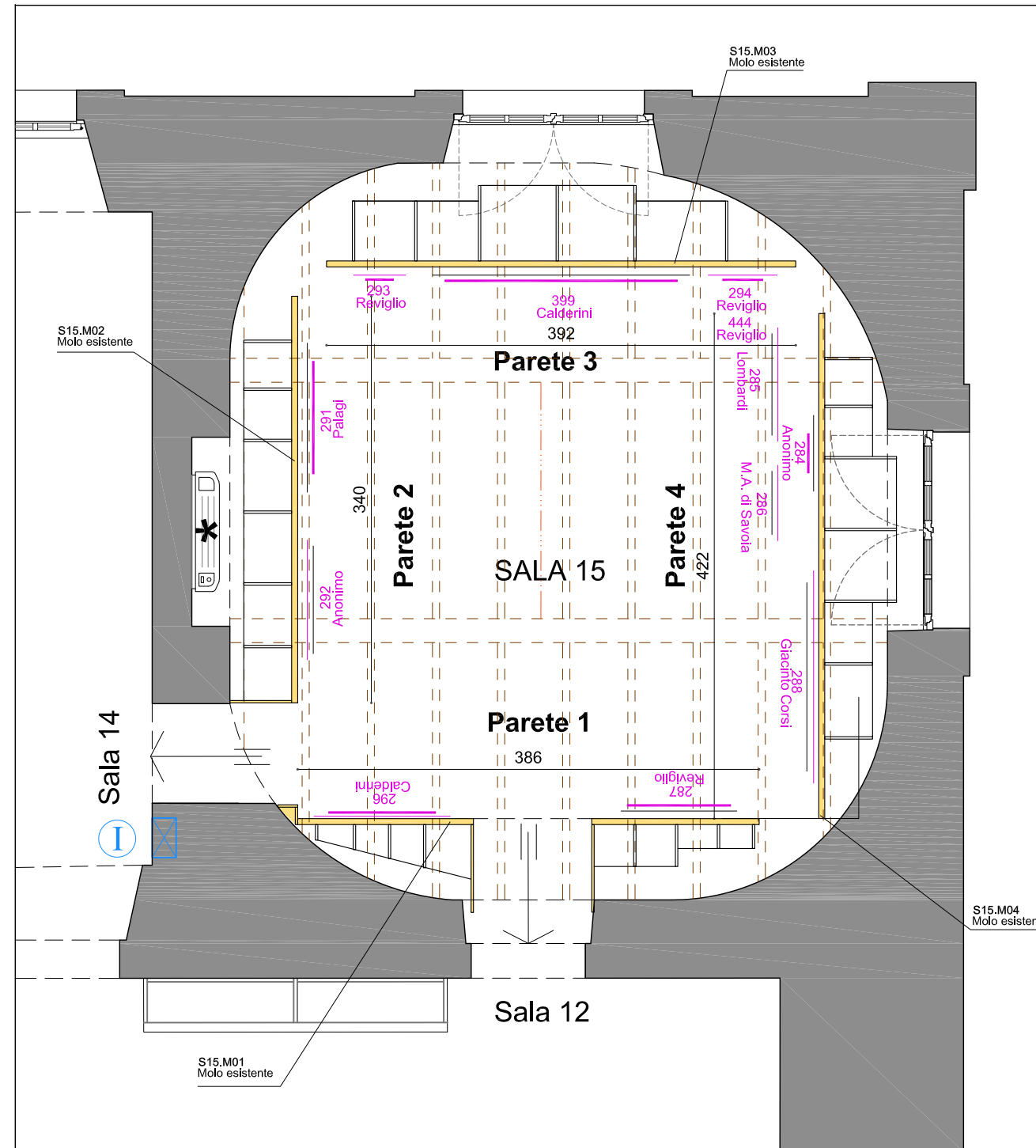



Parete 1

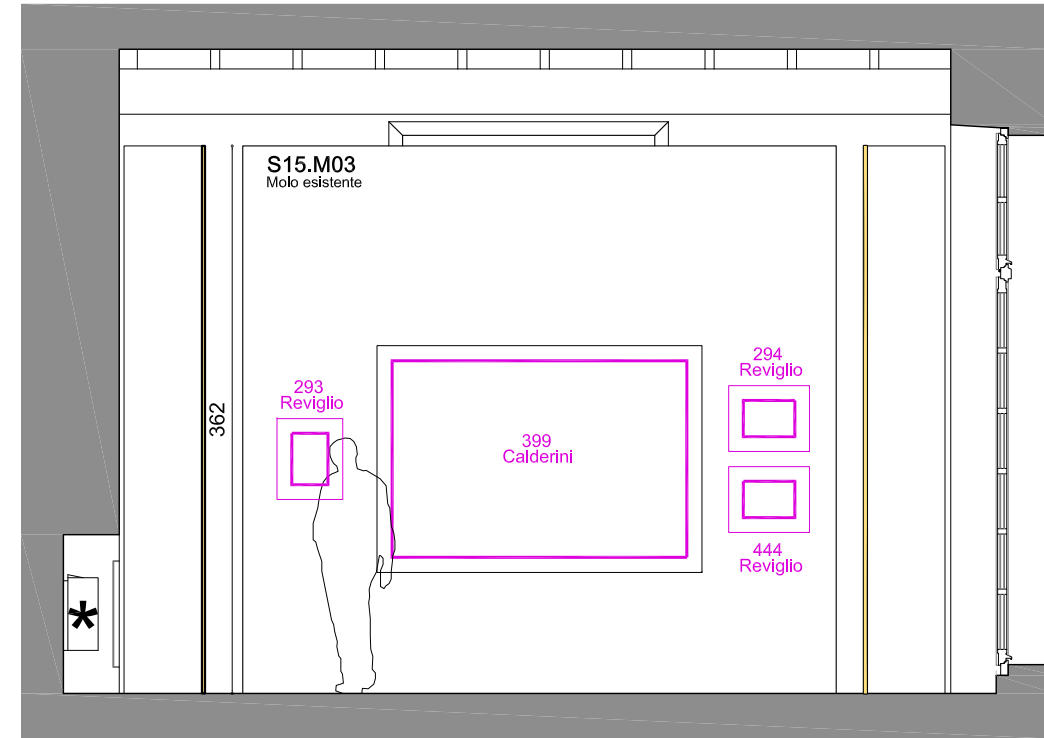

Parete 3



Parete 2

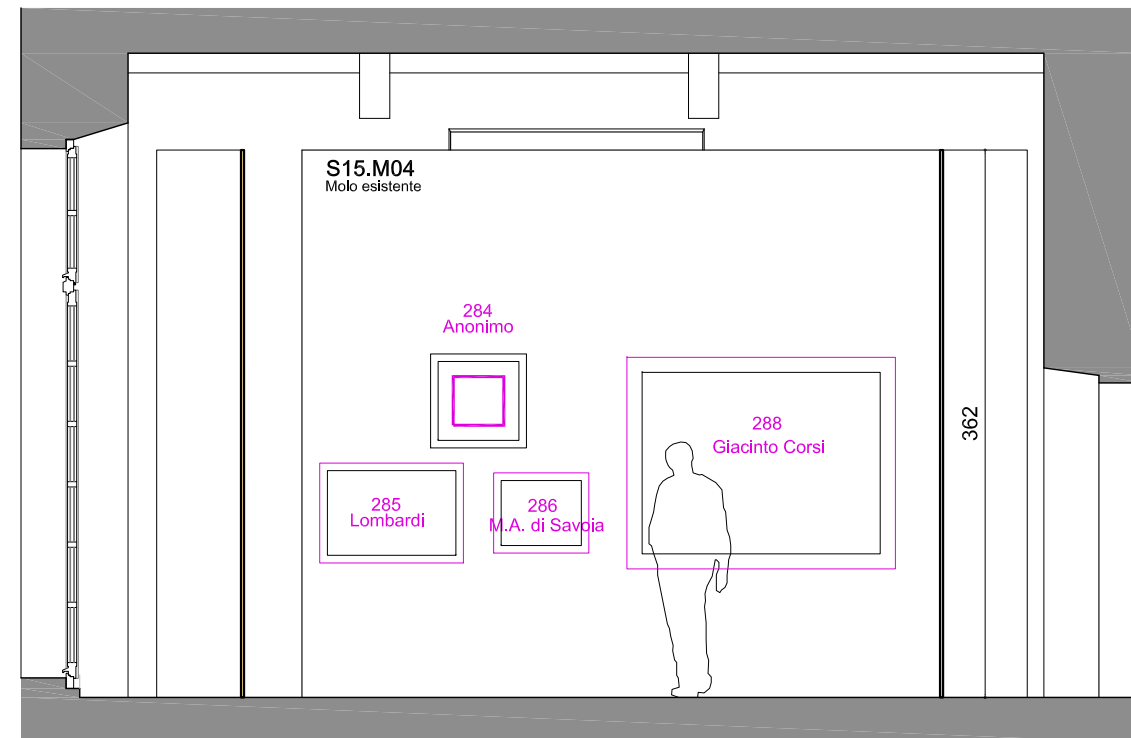

Parete 4

PORZIONE NON OGGETTO DELLA PRESENTE SALA

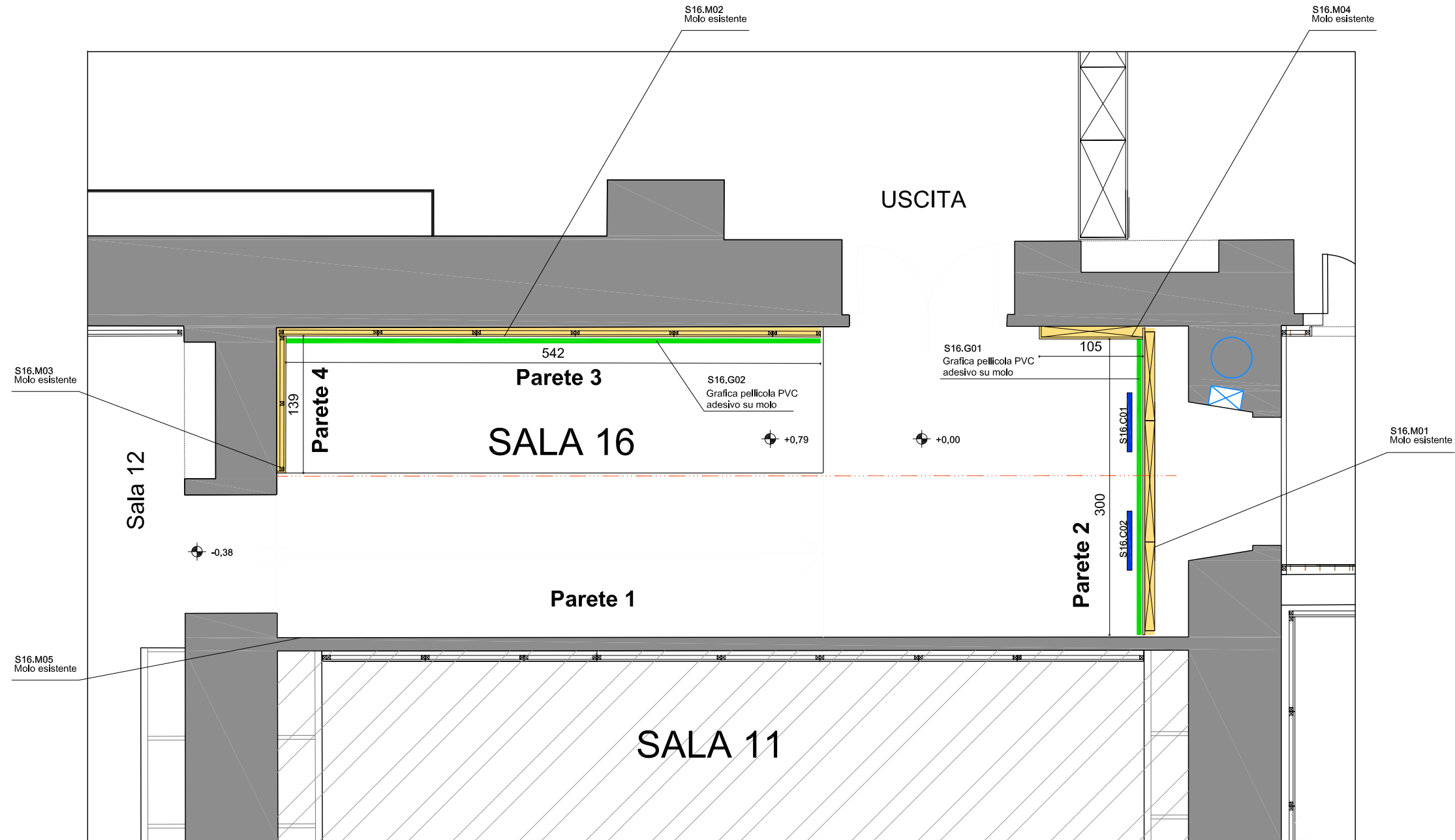

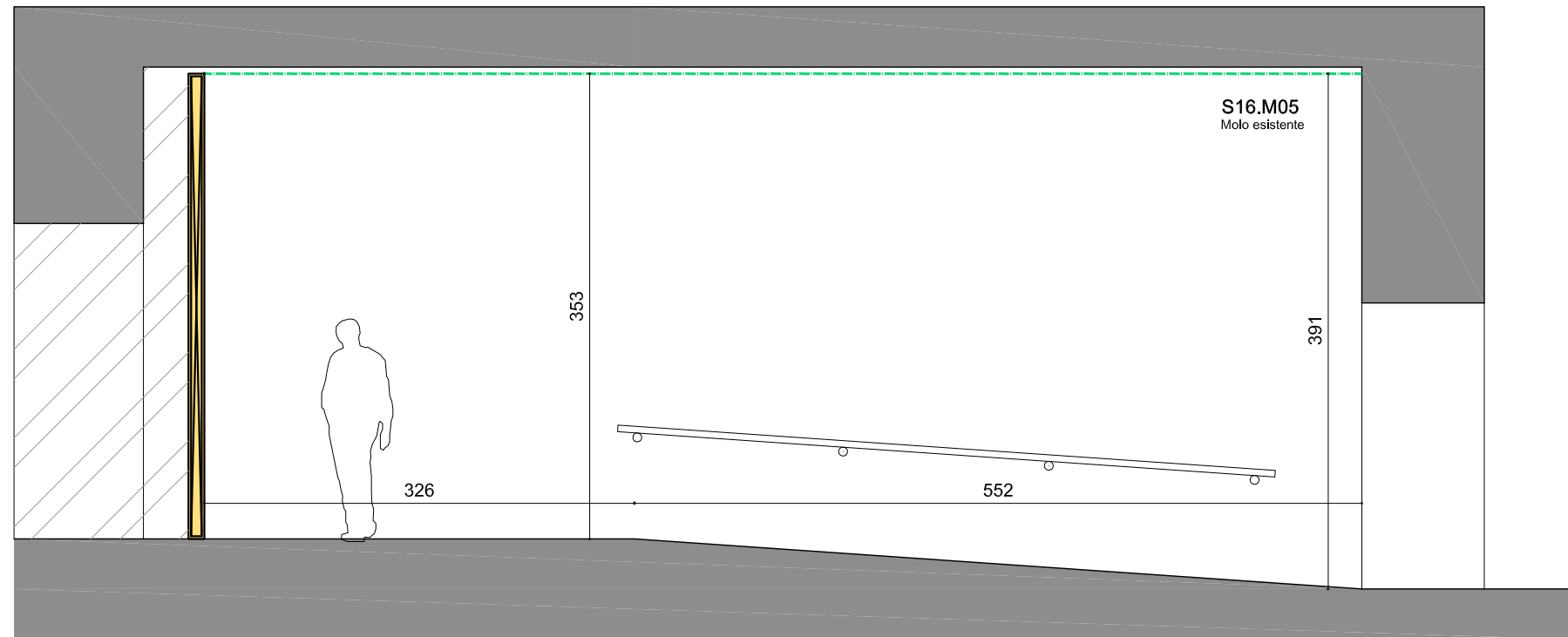

Parete 1

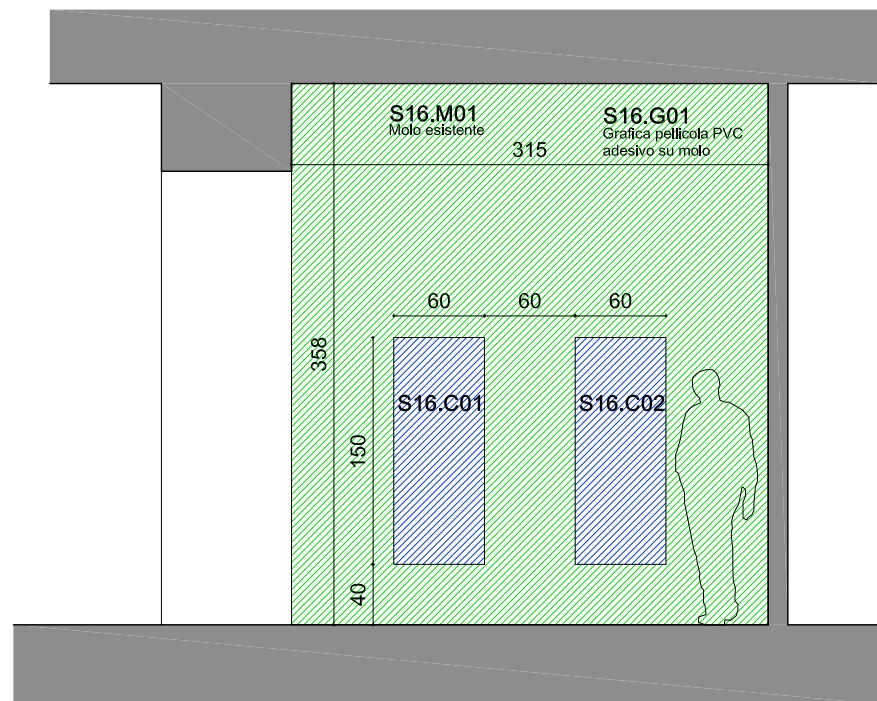

Parete 2

 PORZIONE NON OGGETTO DELLA PRESENTE SALA

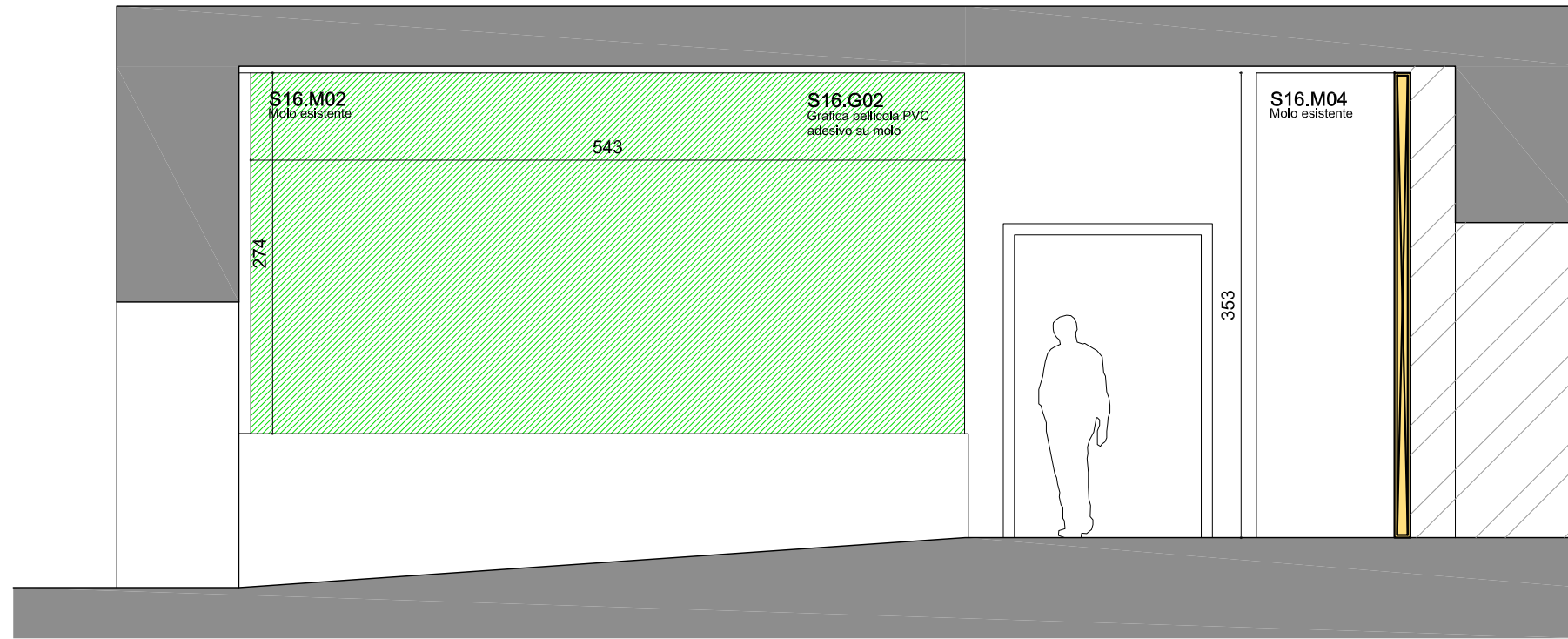

Parete 3

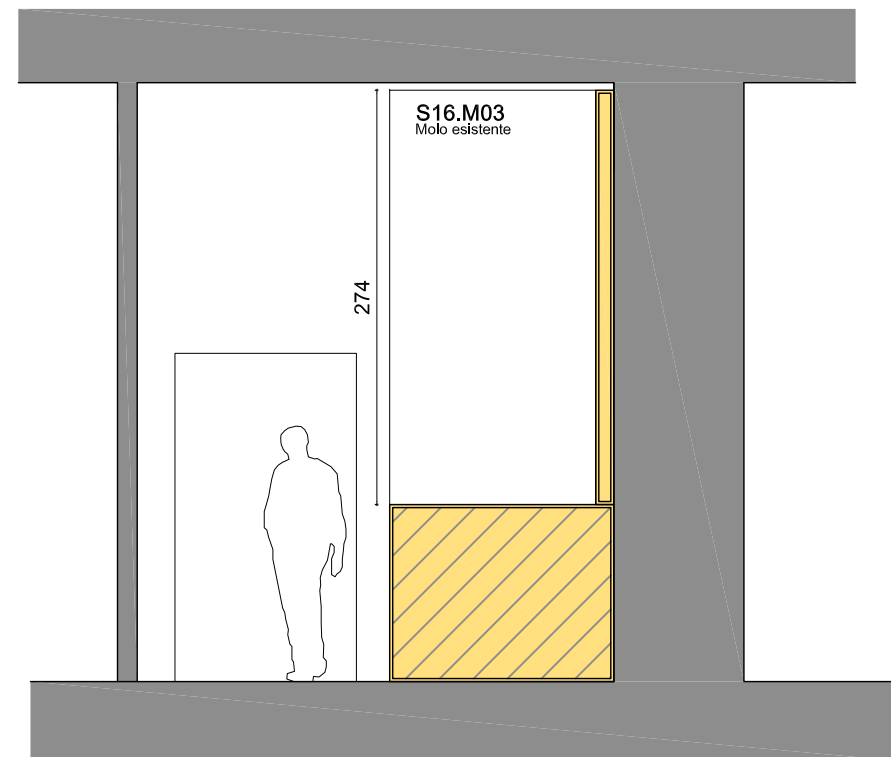

Parete 4

 PORZIONE NON OGGETTO DELLA PRESENTE SALA

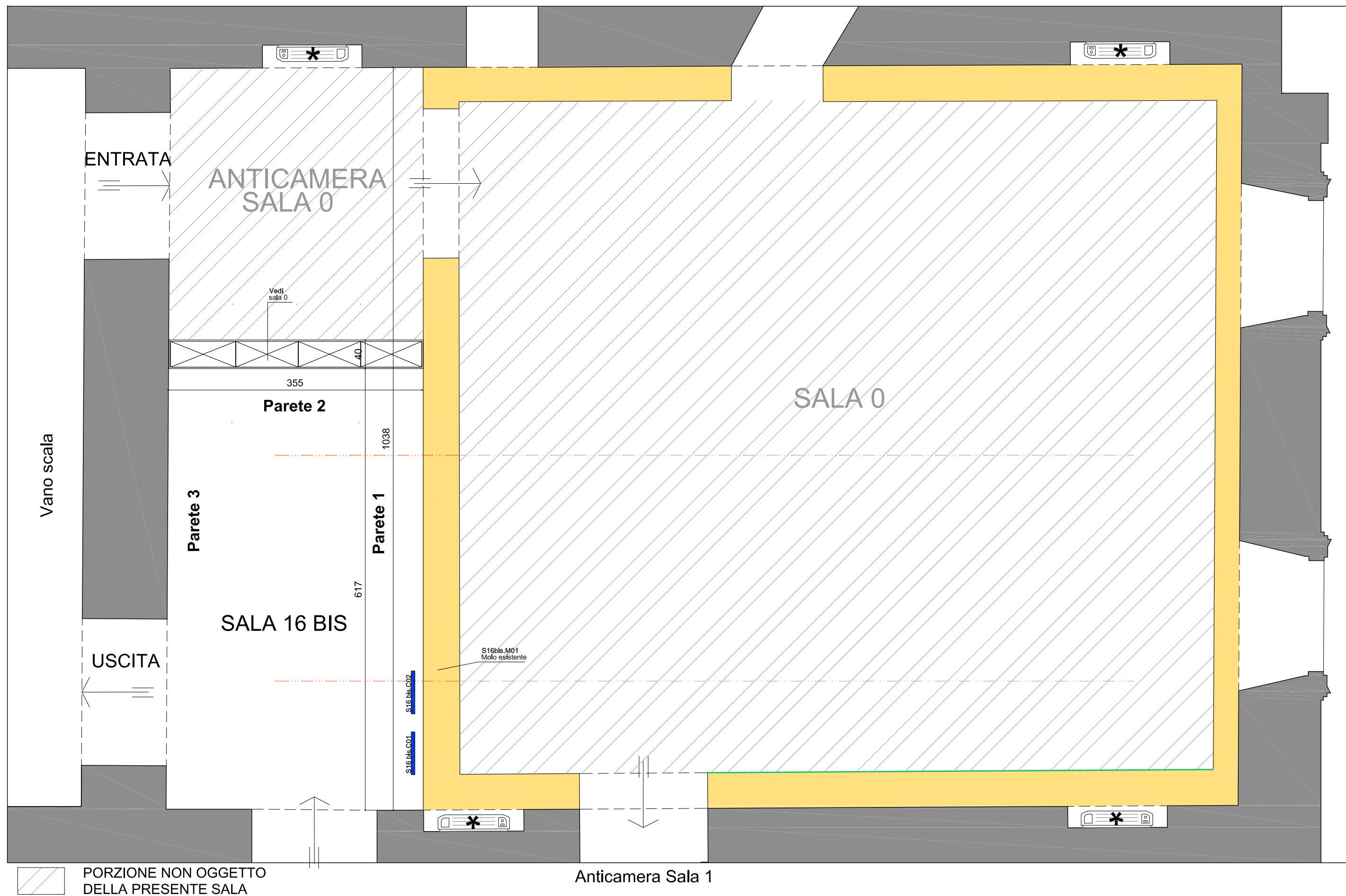

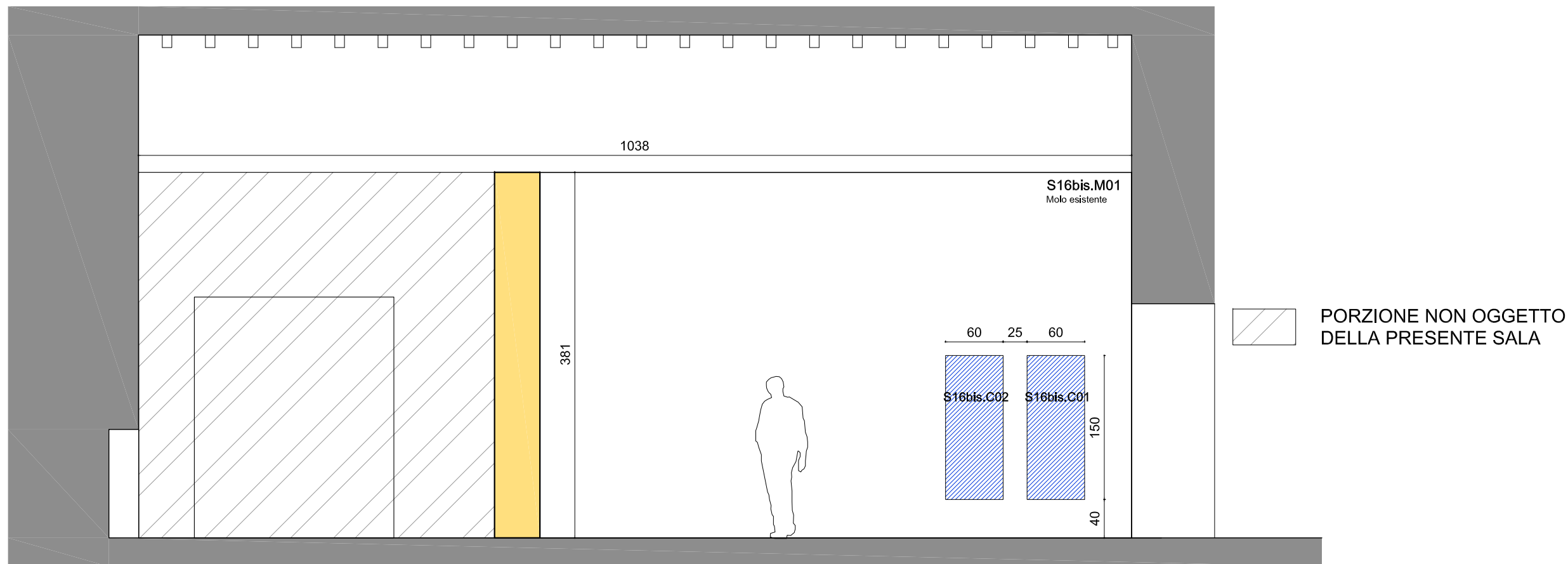

 PORZIONE NON OGGETTO DELLA PRESENTE SALA

Anticamera Sala 1

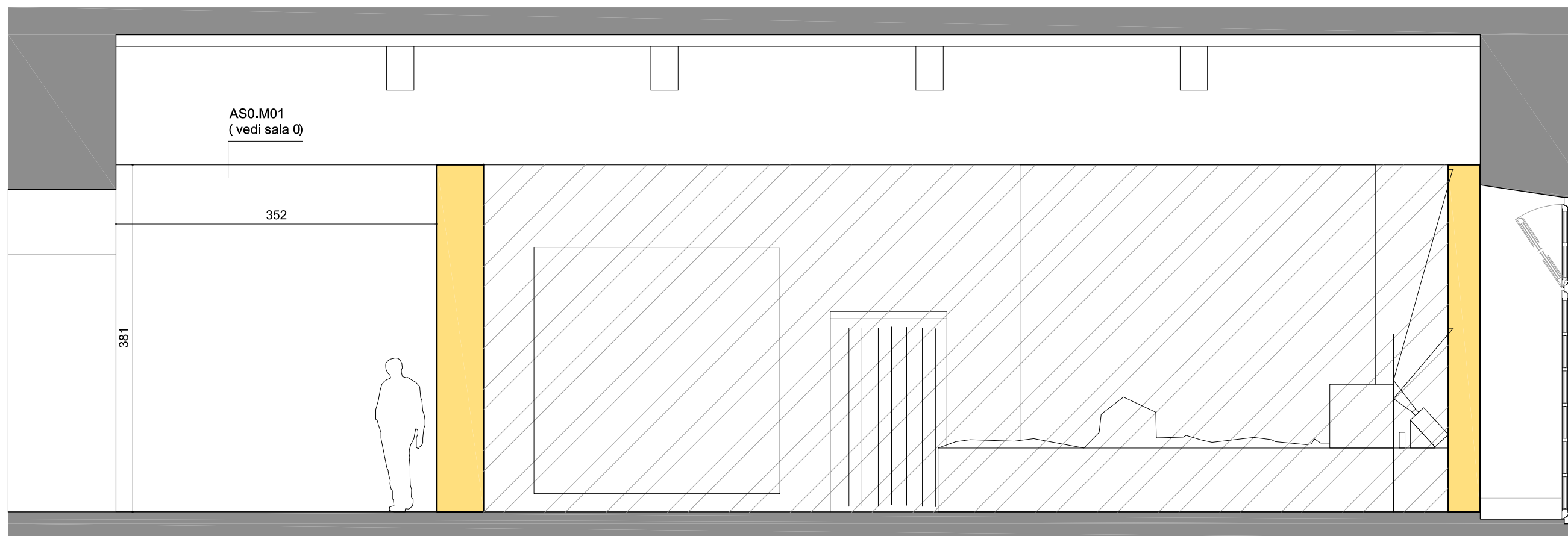

Parete 1



Parete 2

PART. 1
Fissaggio canvas alla parete in mdf del molo

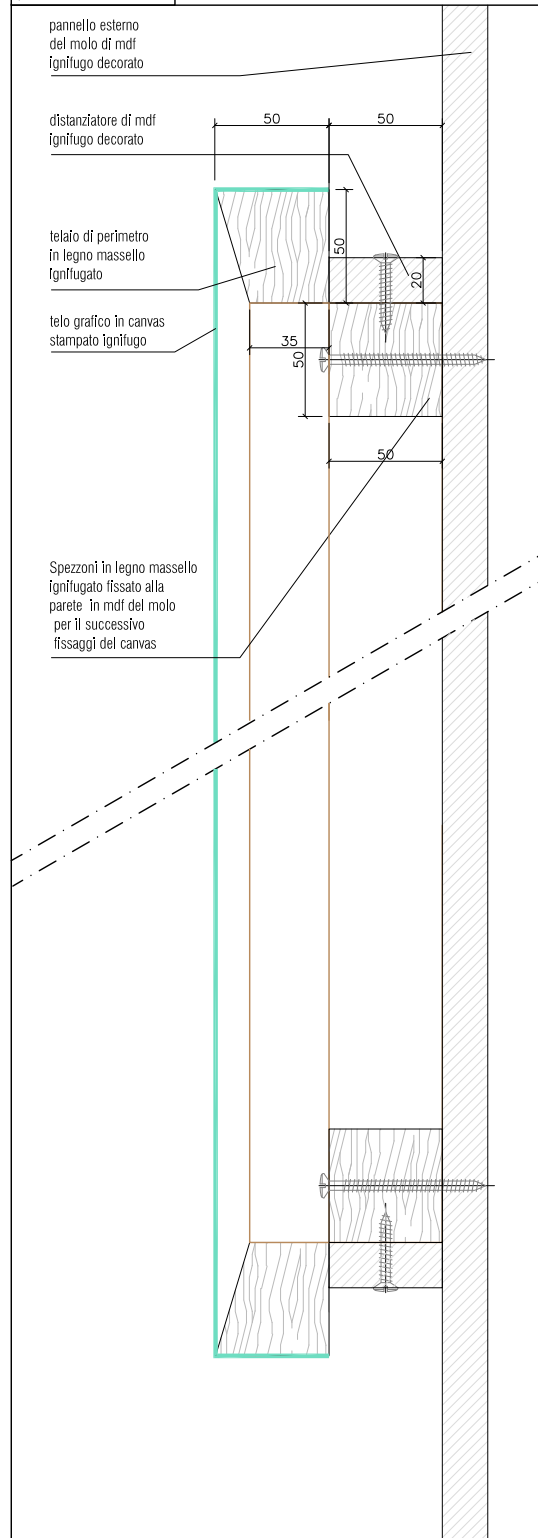

S16 bis.CO1/C02

Telaio ligneo sparapuntato con telo grafico realizzato in masselli di legno ignifugato

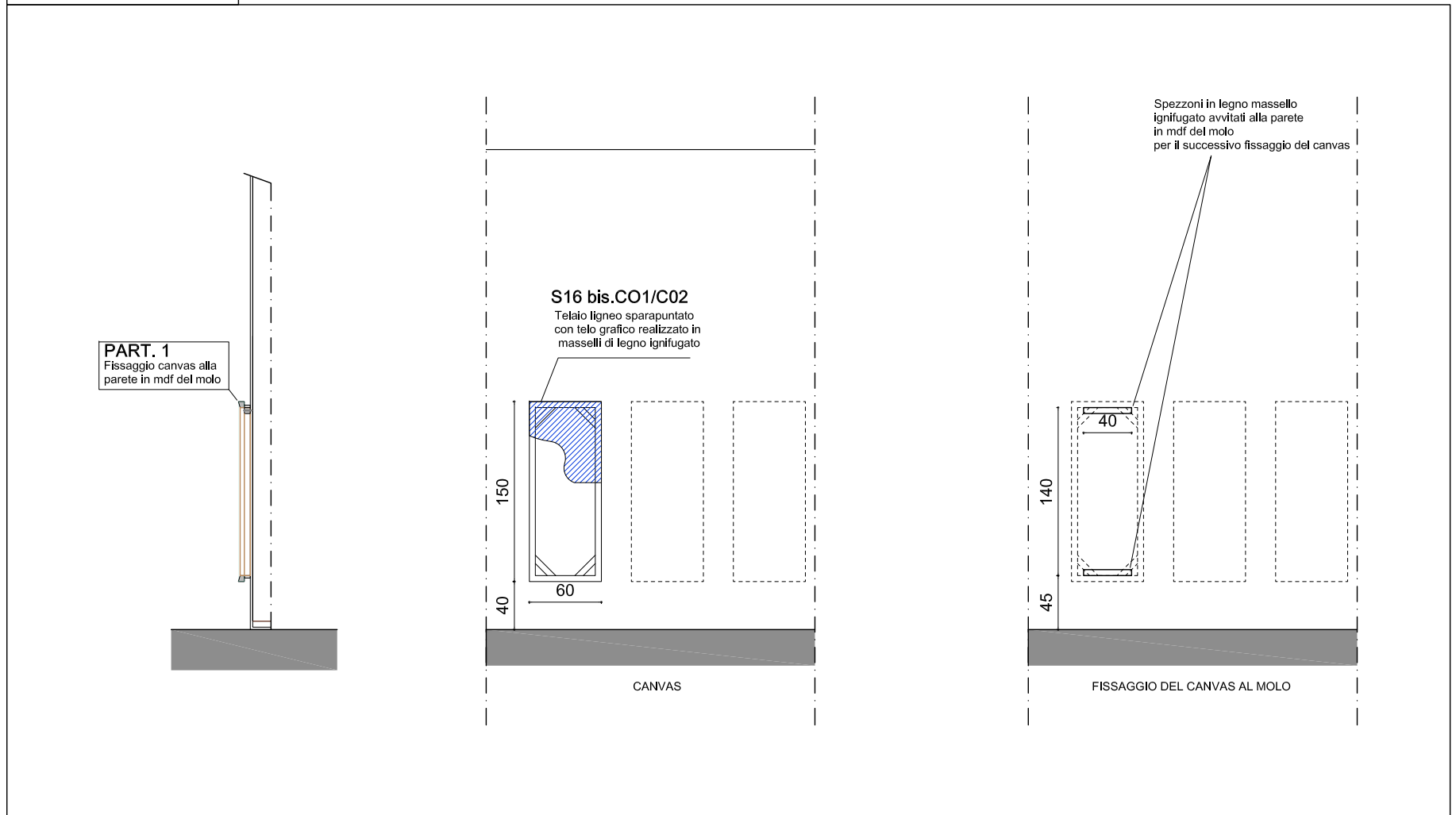

G SUP LIBRI
Supporti per libri

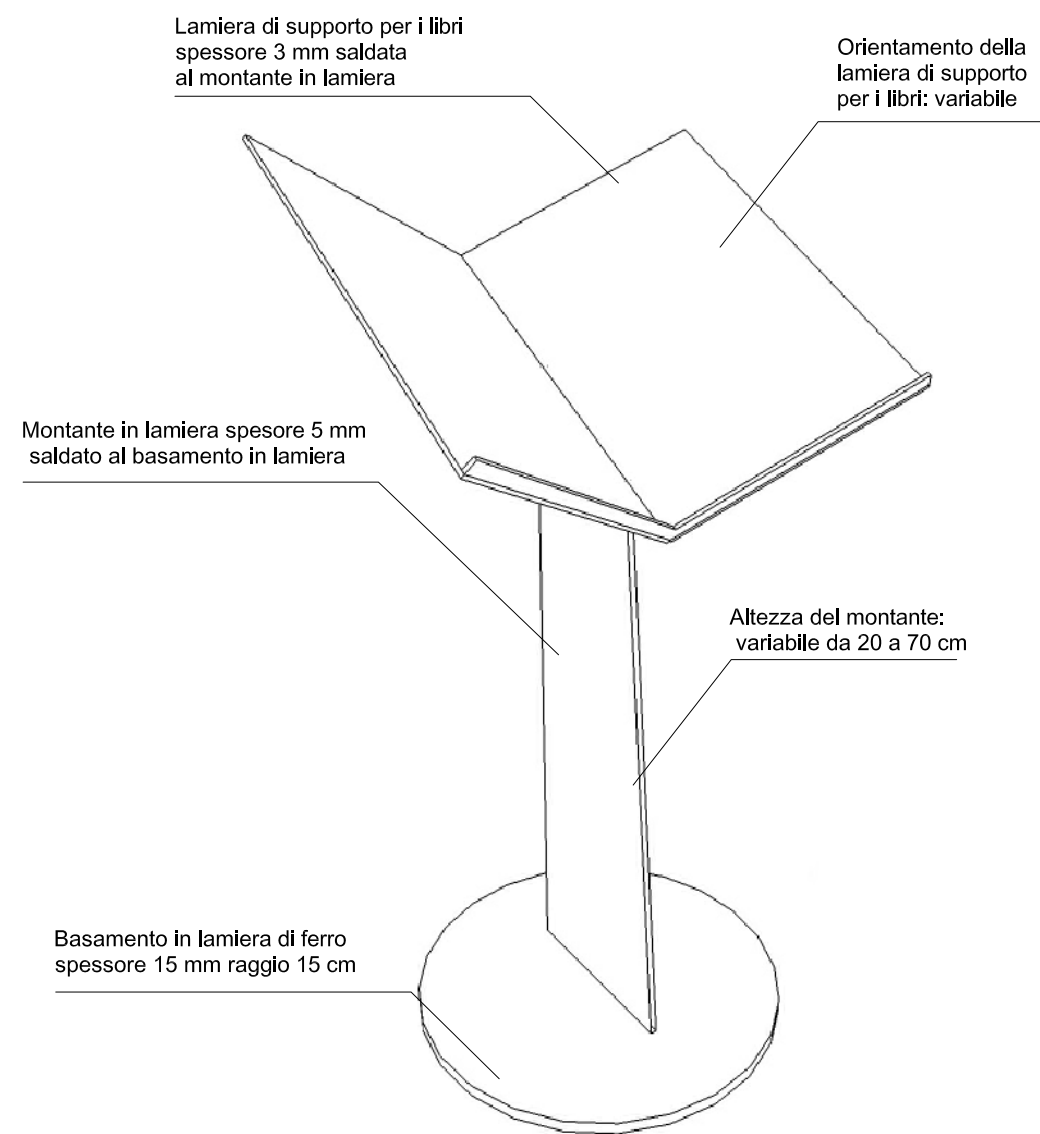

G SUP DIDA
Supporti per didascalie

