

REGGIA DI VENARIA Sale delle Arti piano primo

Fornitura e posa in opera
di allestimenti per la mostra

JUNGLE

L'immaginario animale delle moda

PROGETTO ESECUTIVO

04

ABACO DEGLI ALLESTIMENTI

RESPONSABILE UNICO DEL PROCEDIMENTO
Gianbeppe Colombano

PROGETTO DI ALLESTIMENTO
Loredana Iacopino

PROGETTO SCENOGRAFICO
a cura di Pietro Ruffo

Febbraio 2017

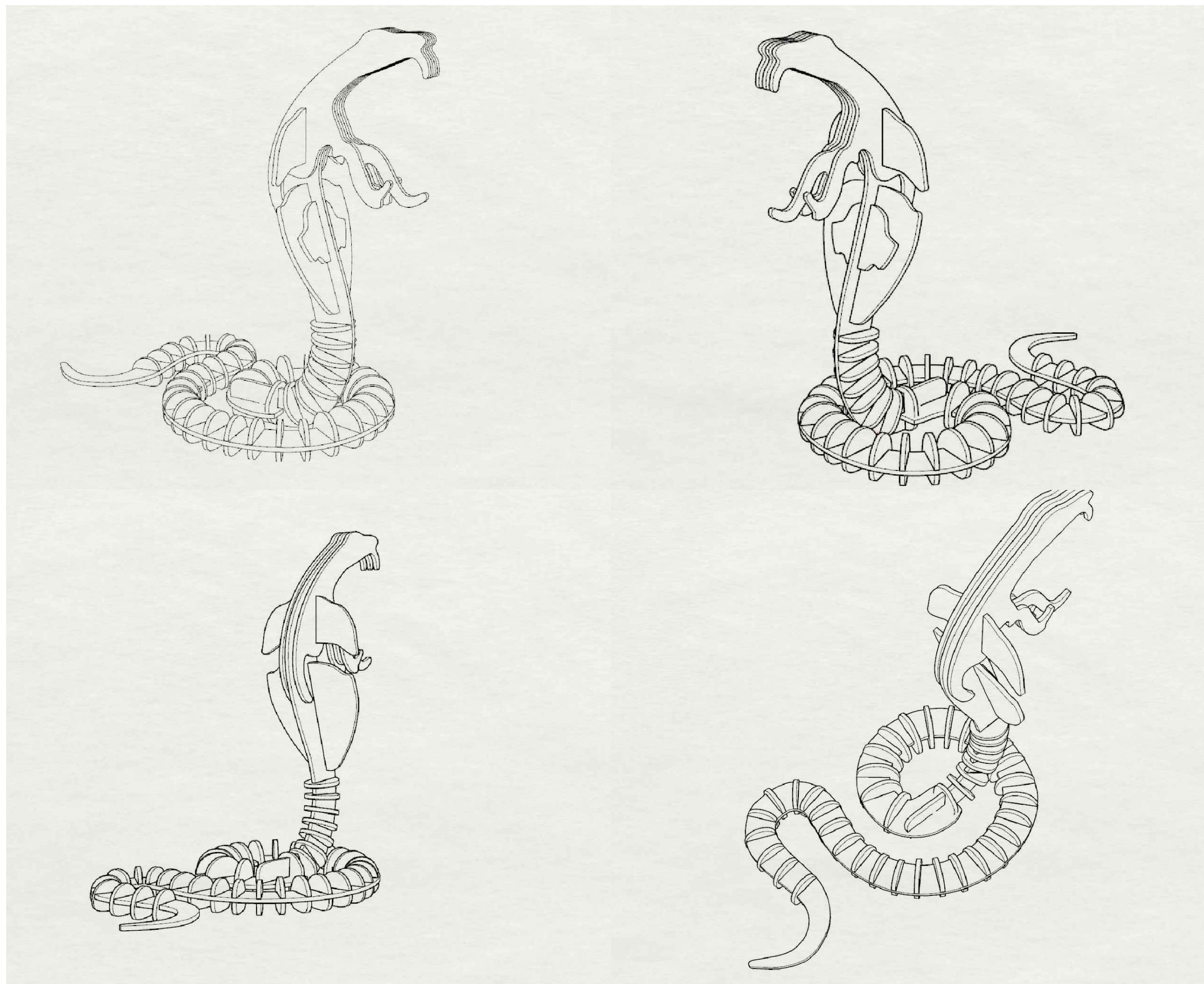

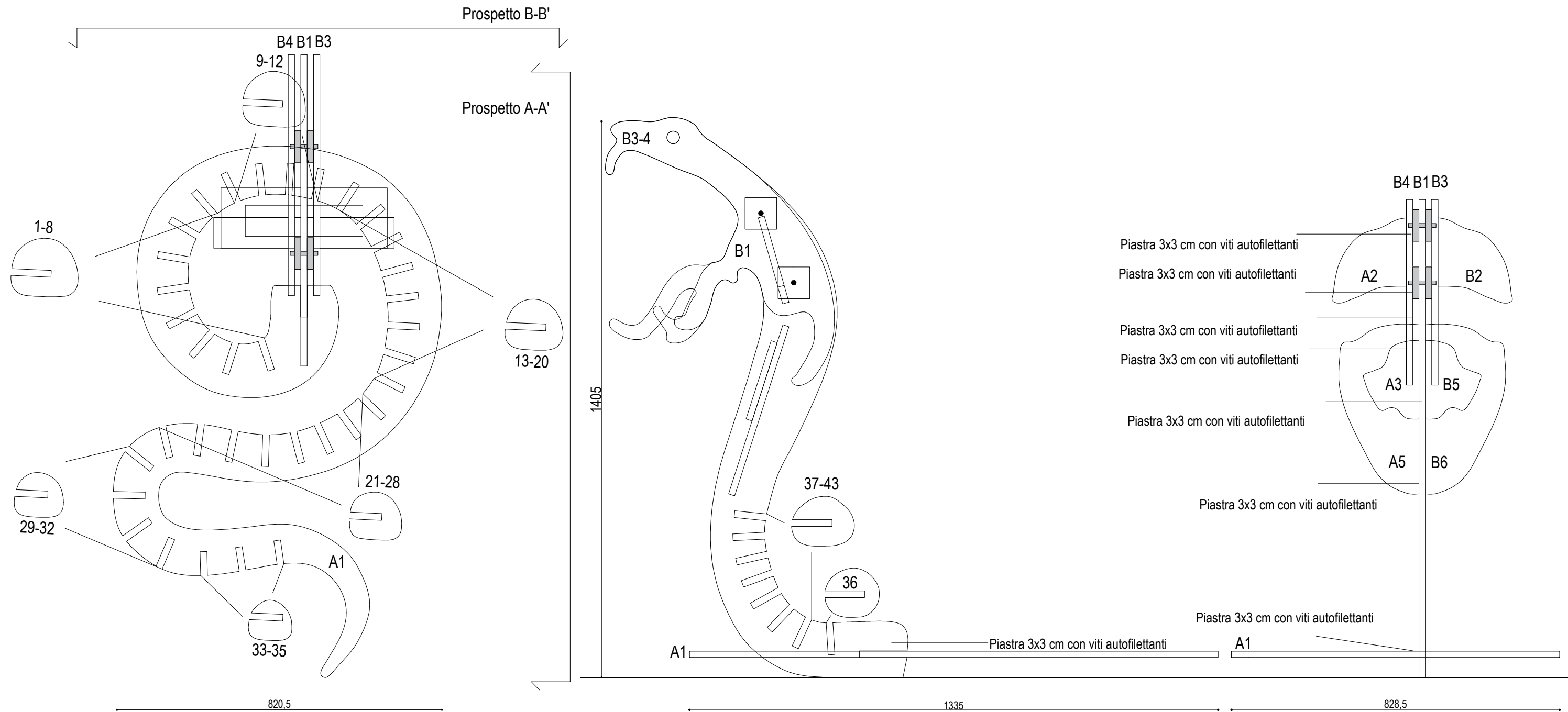

PIANTA

PROSPETTO A-A'

PROSPETTO B-B'

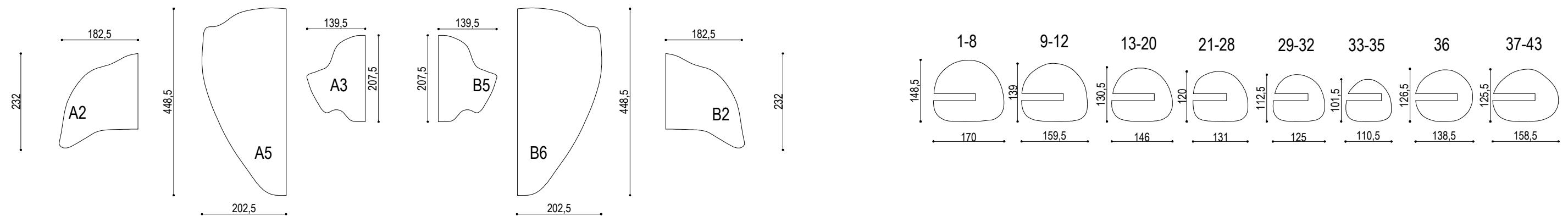

ABACO ELEMENTI

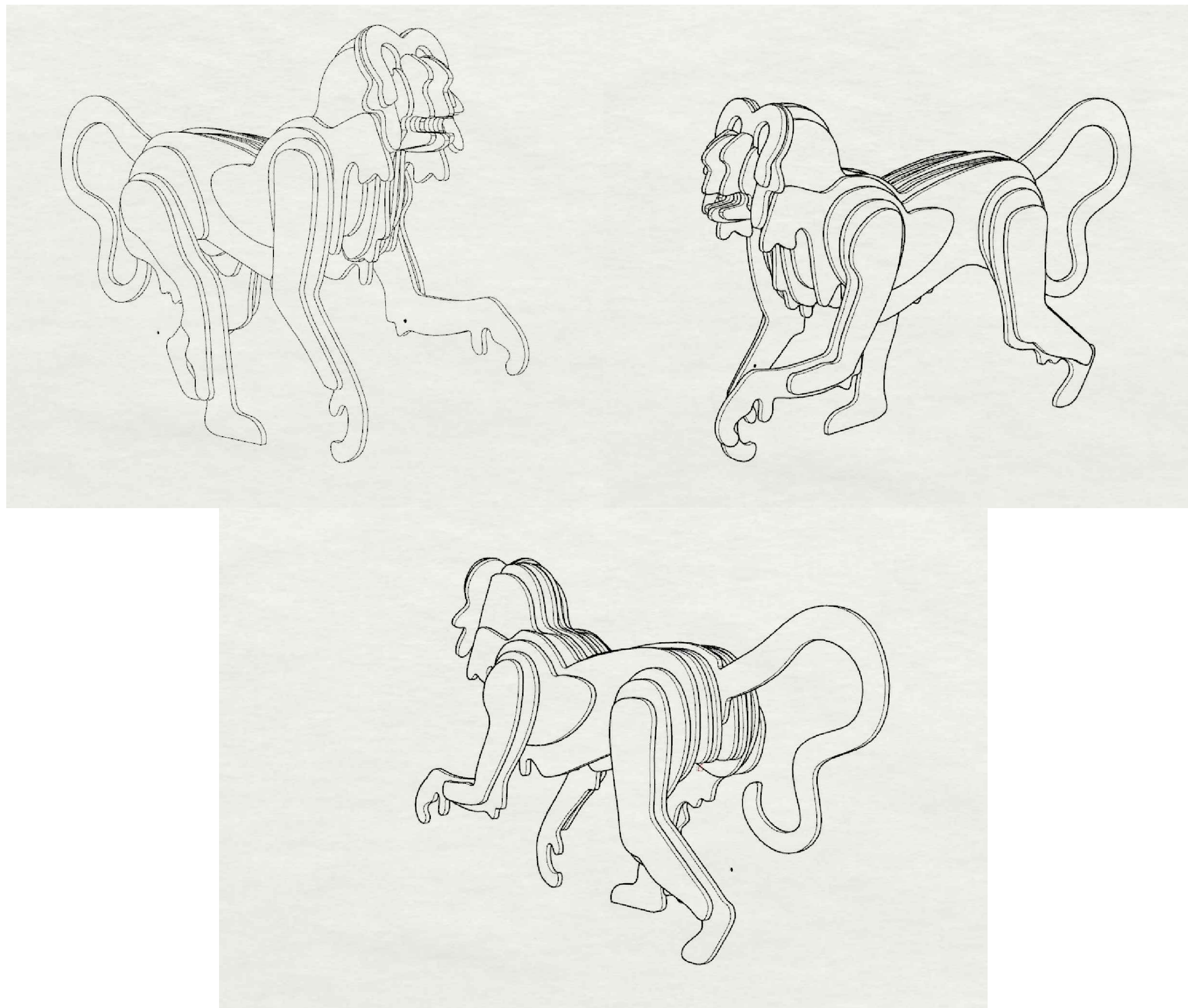

PIANTA

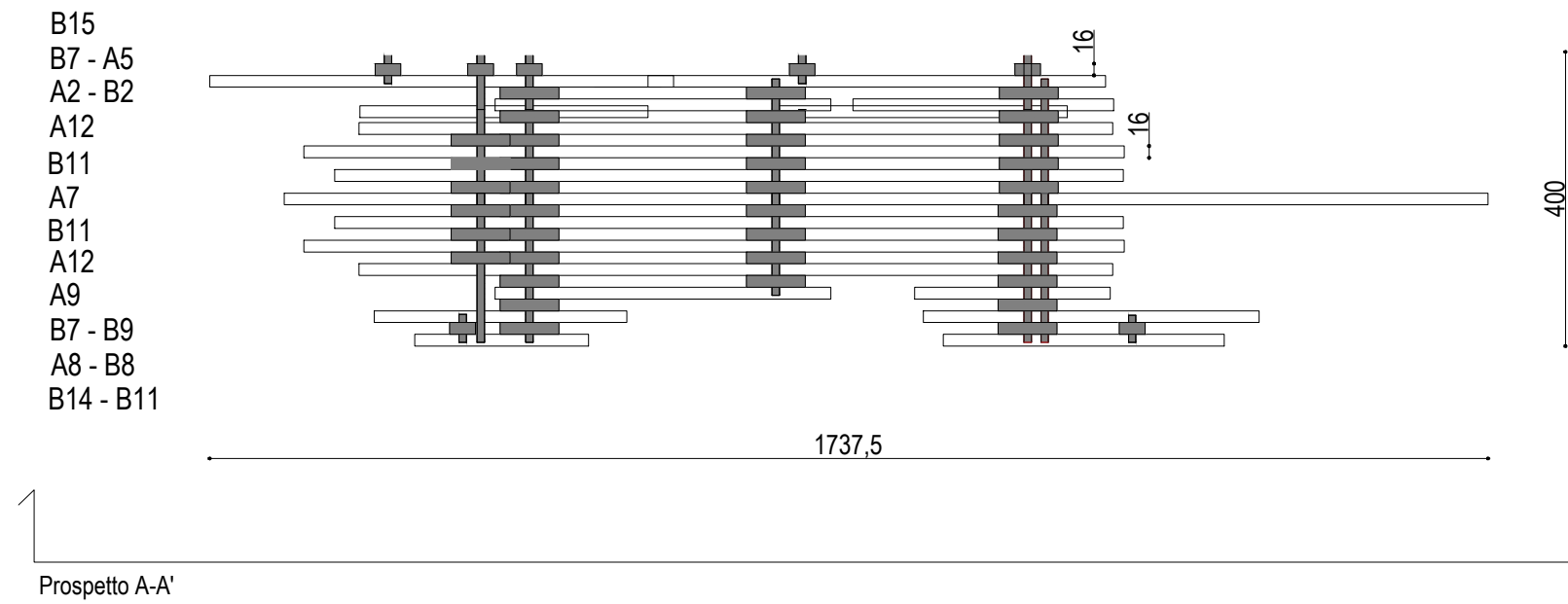

PROSPETTO A-A'

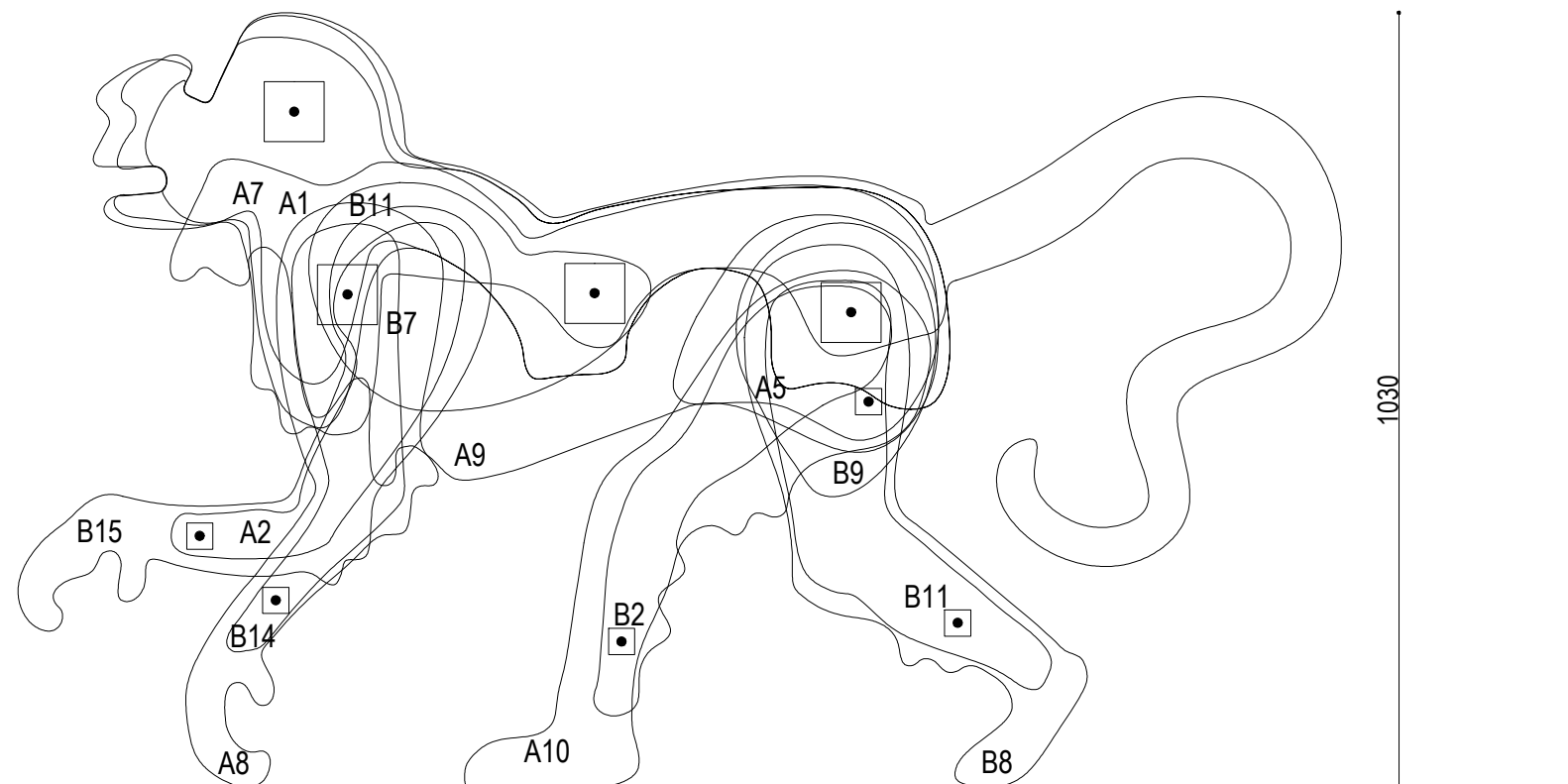

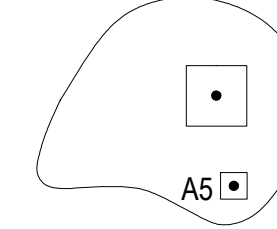
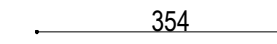
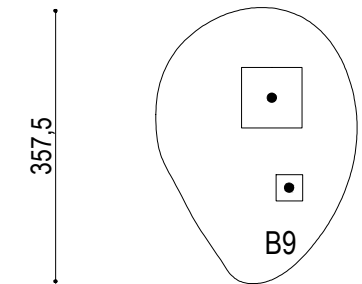
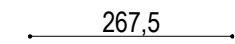
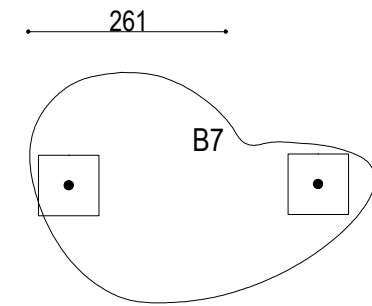
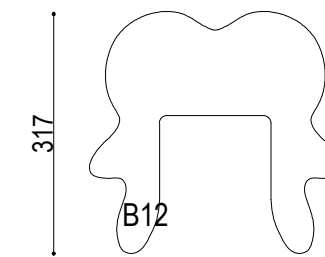
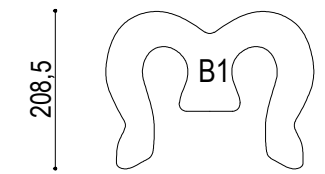
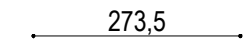
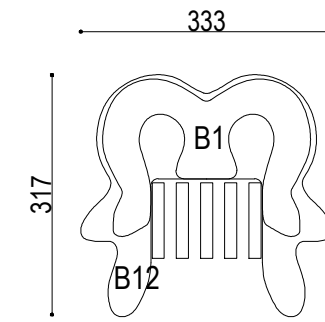
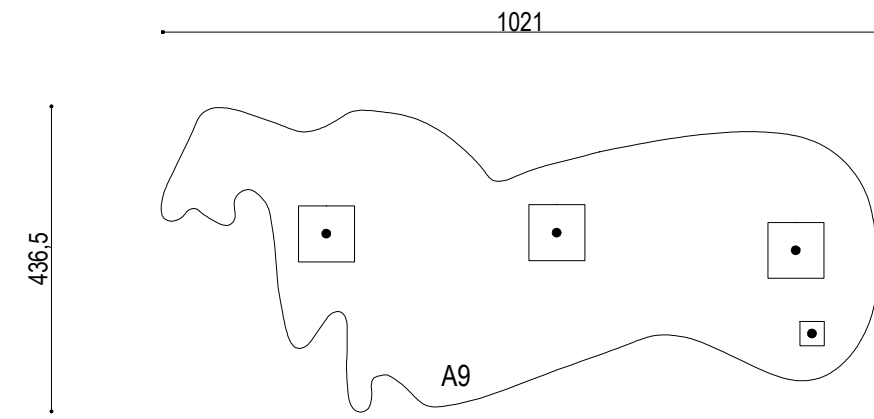
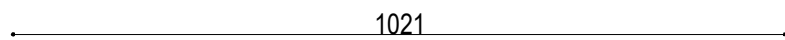
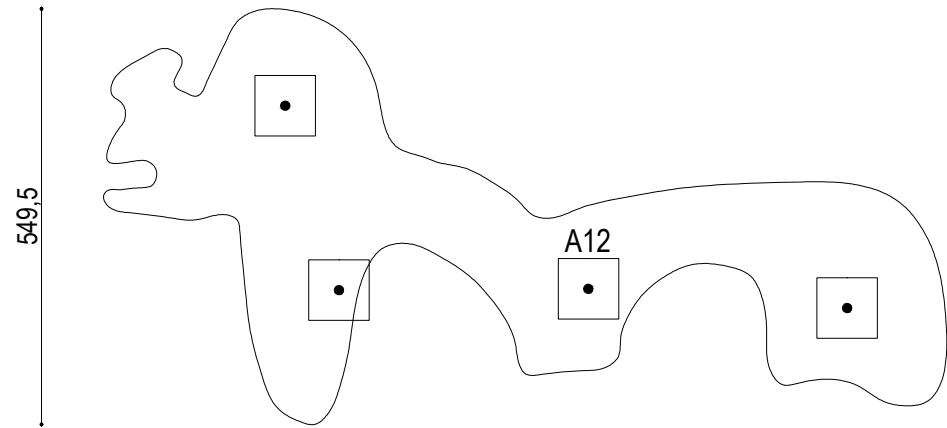
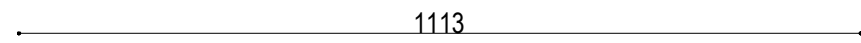
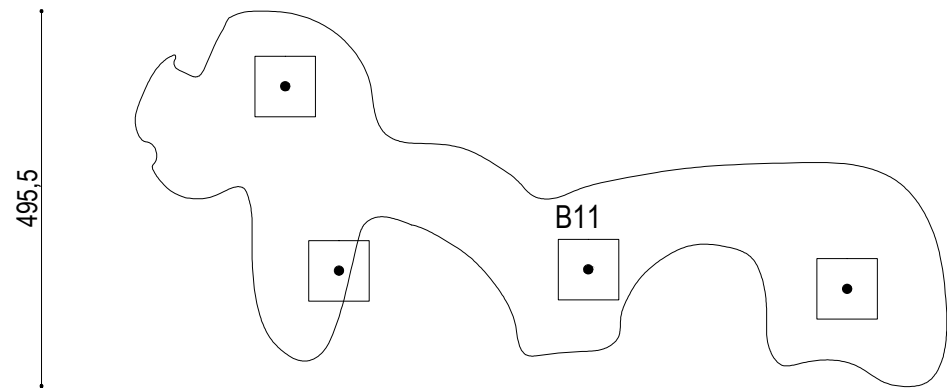
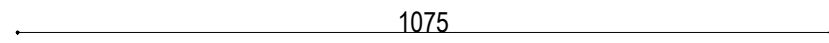
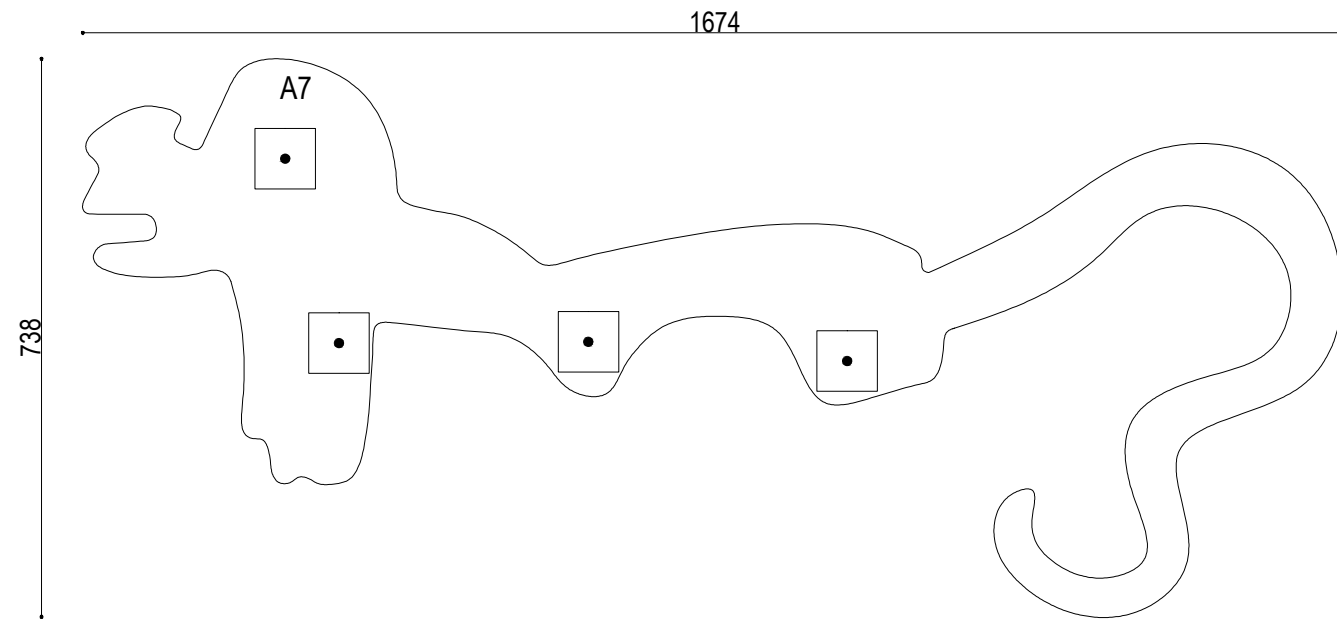

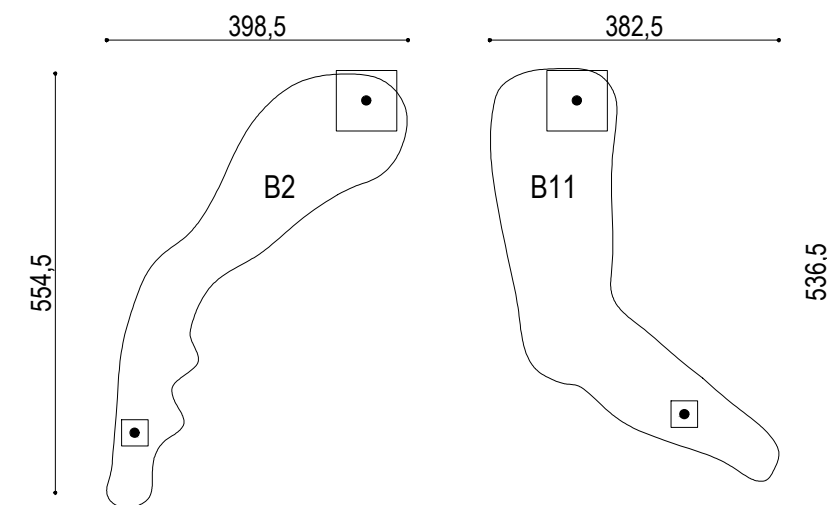
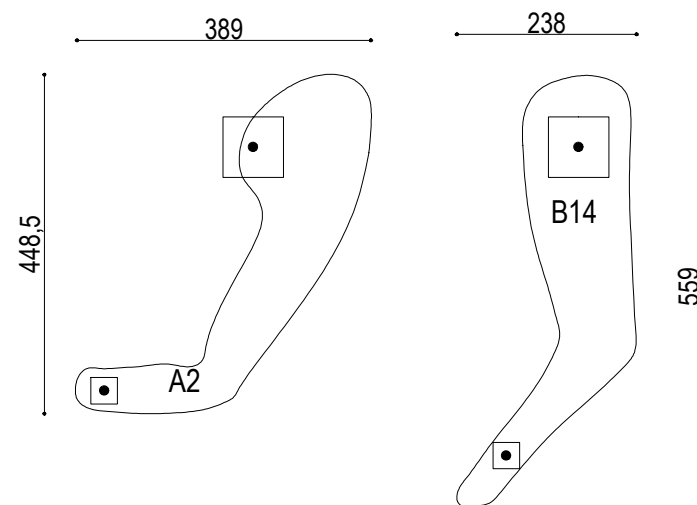
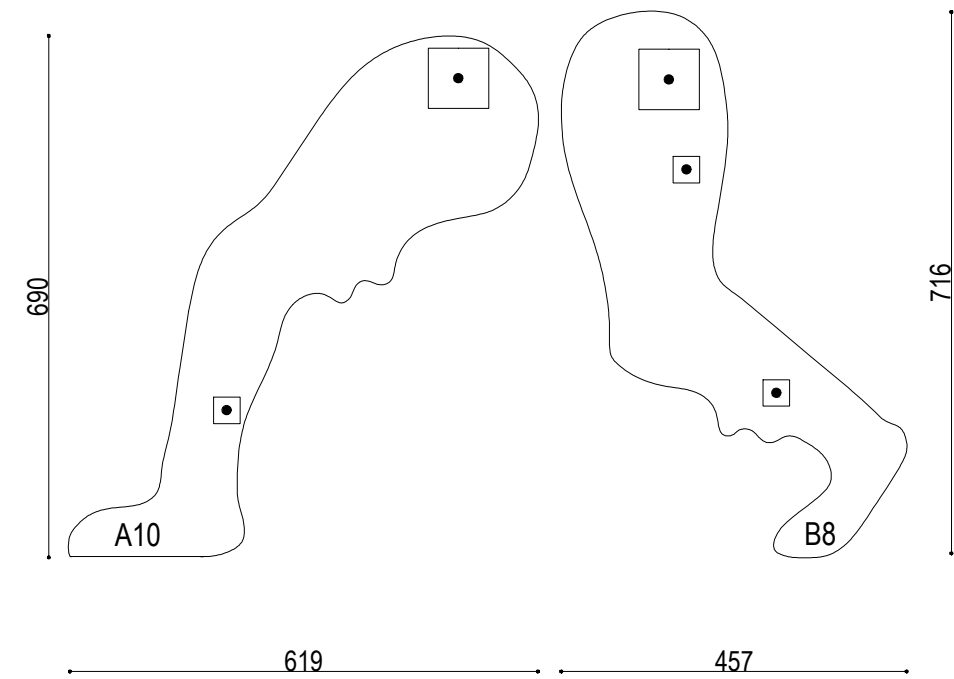
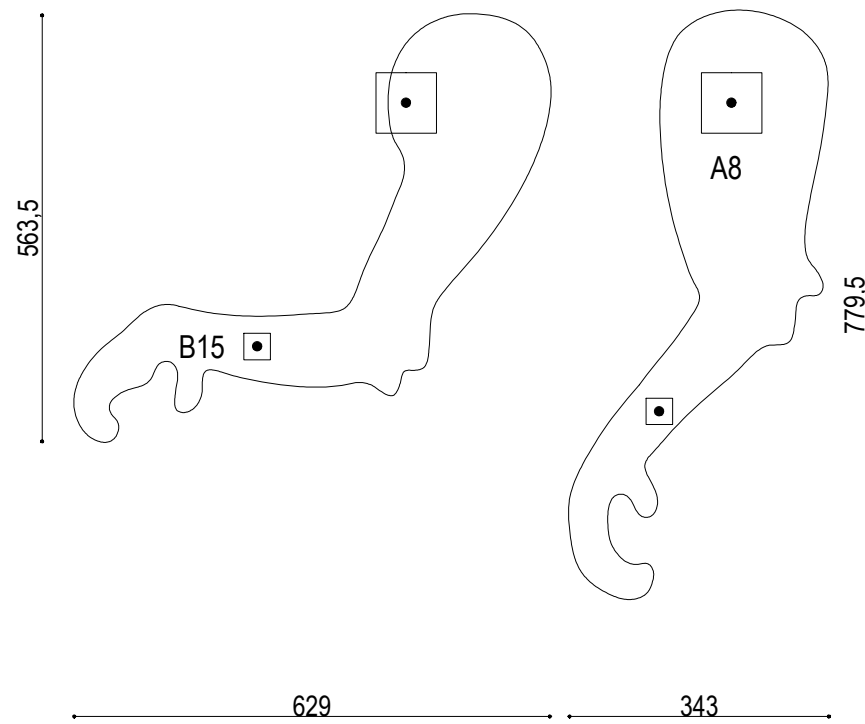

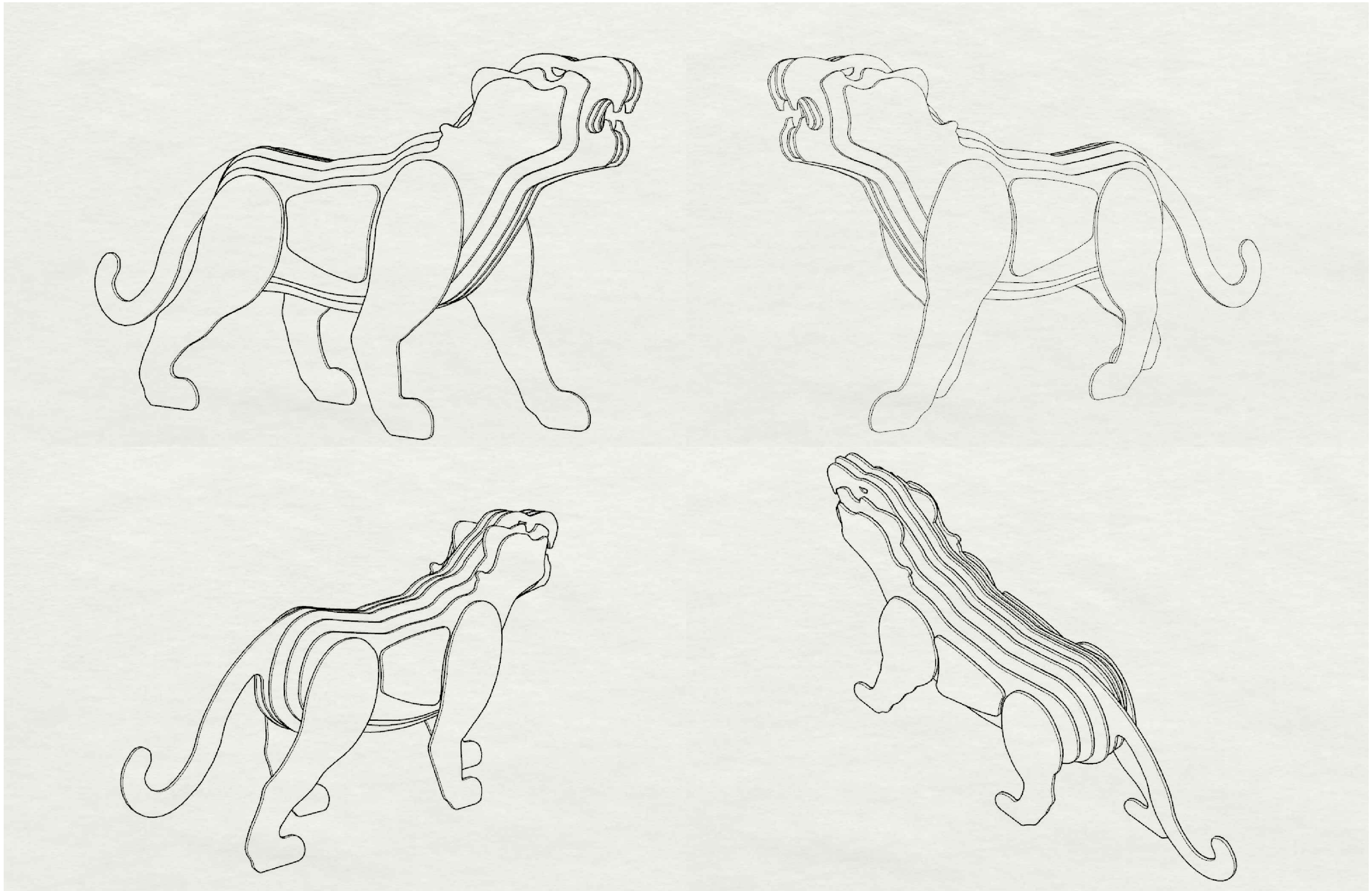

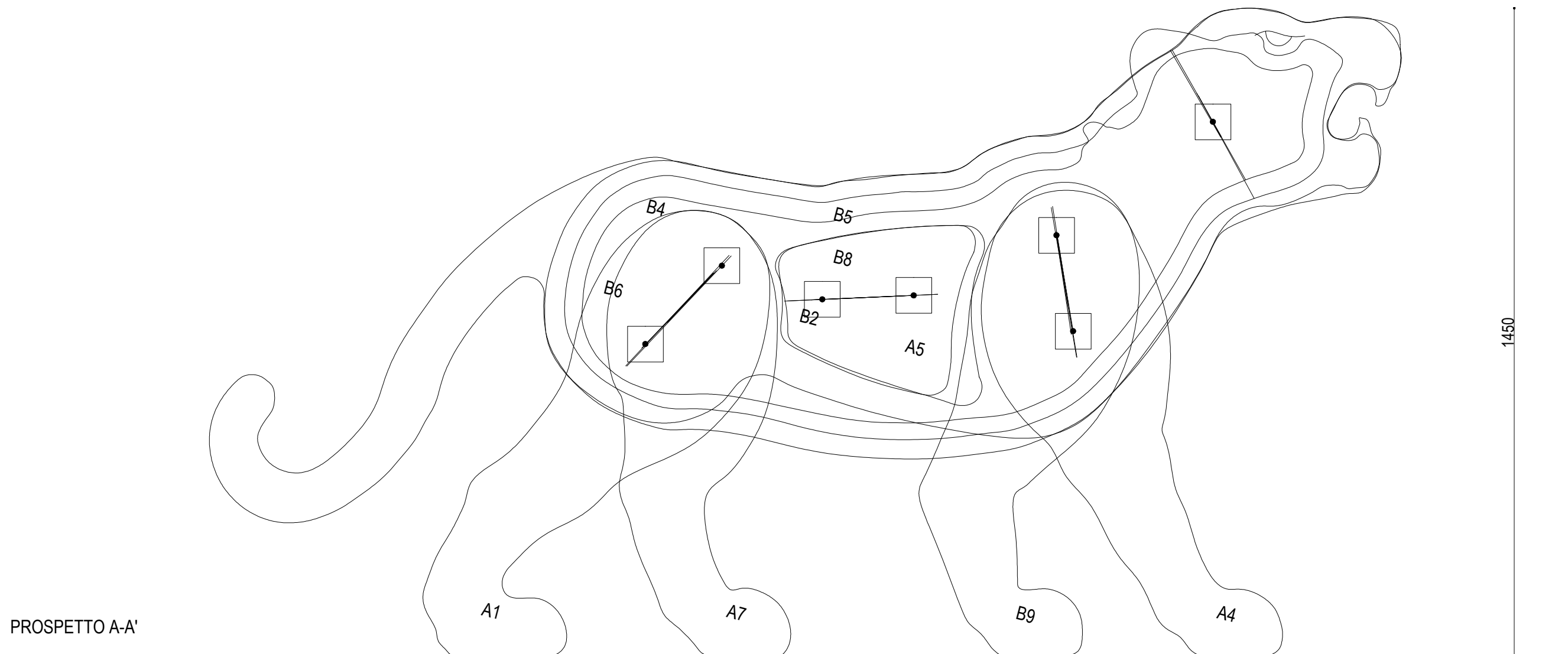
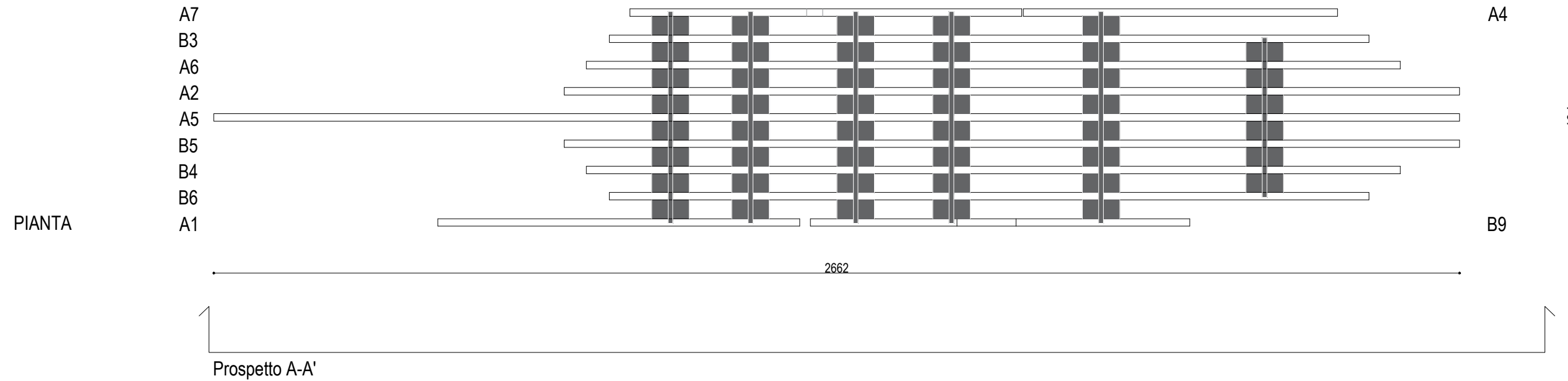

2666,5

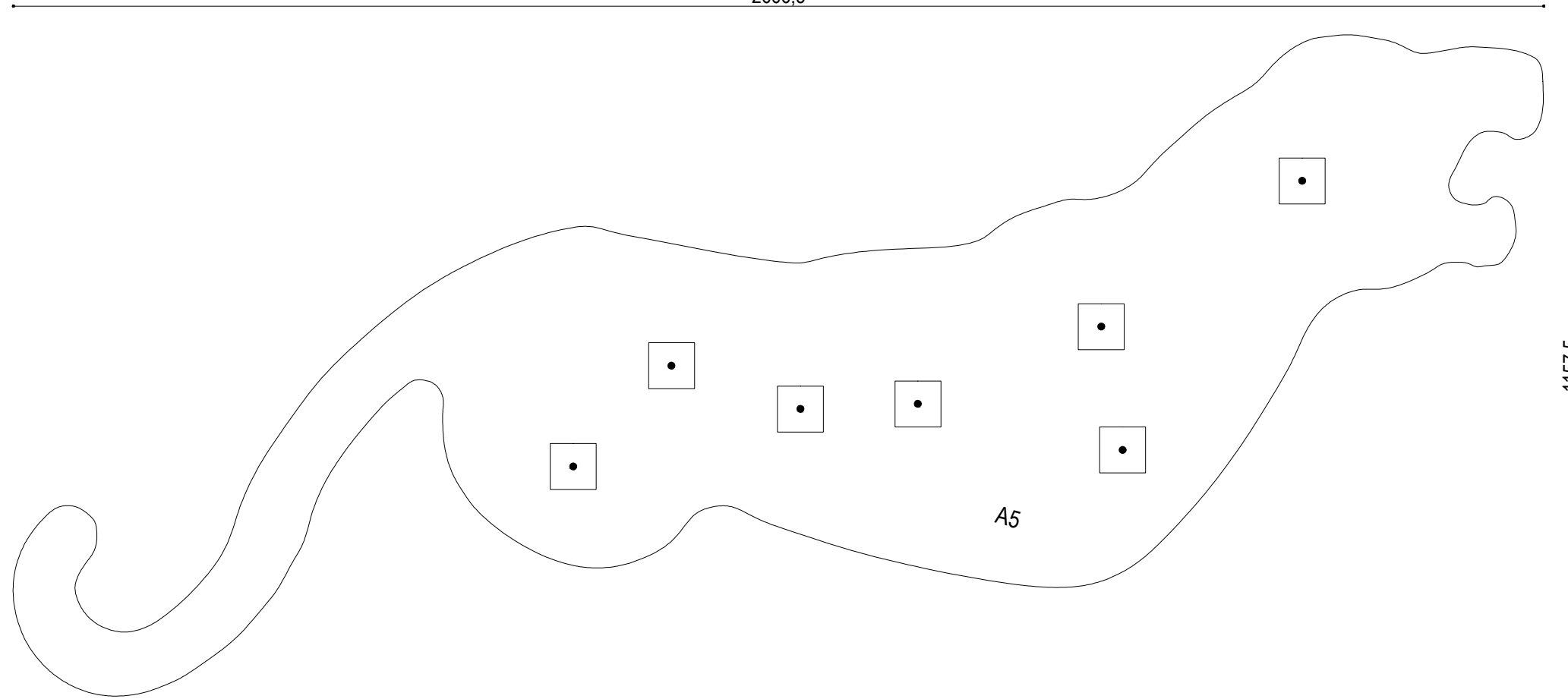

1157,5

1919,5

1919,5

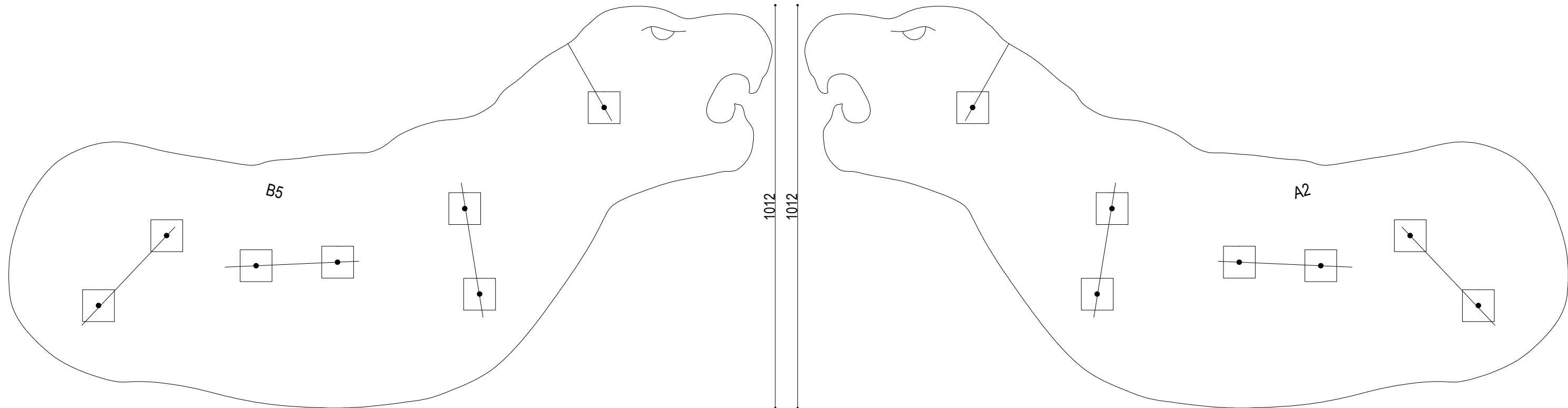

1012

1012

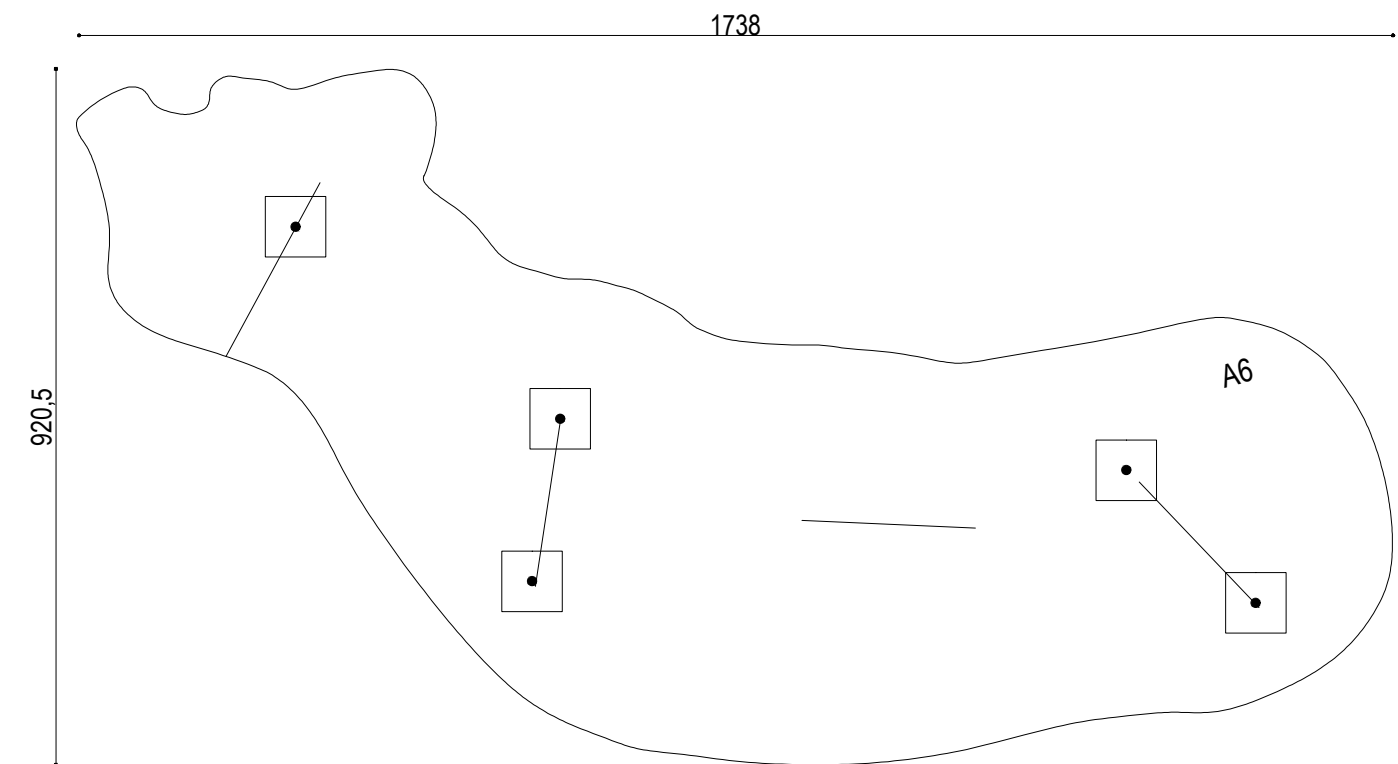
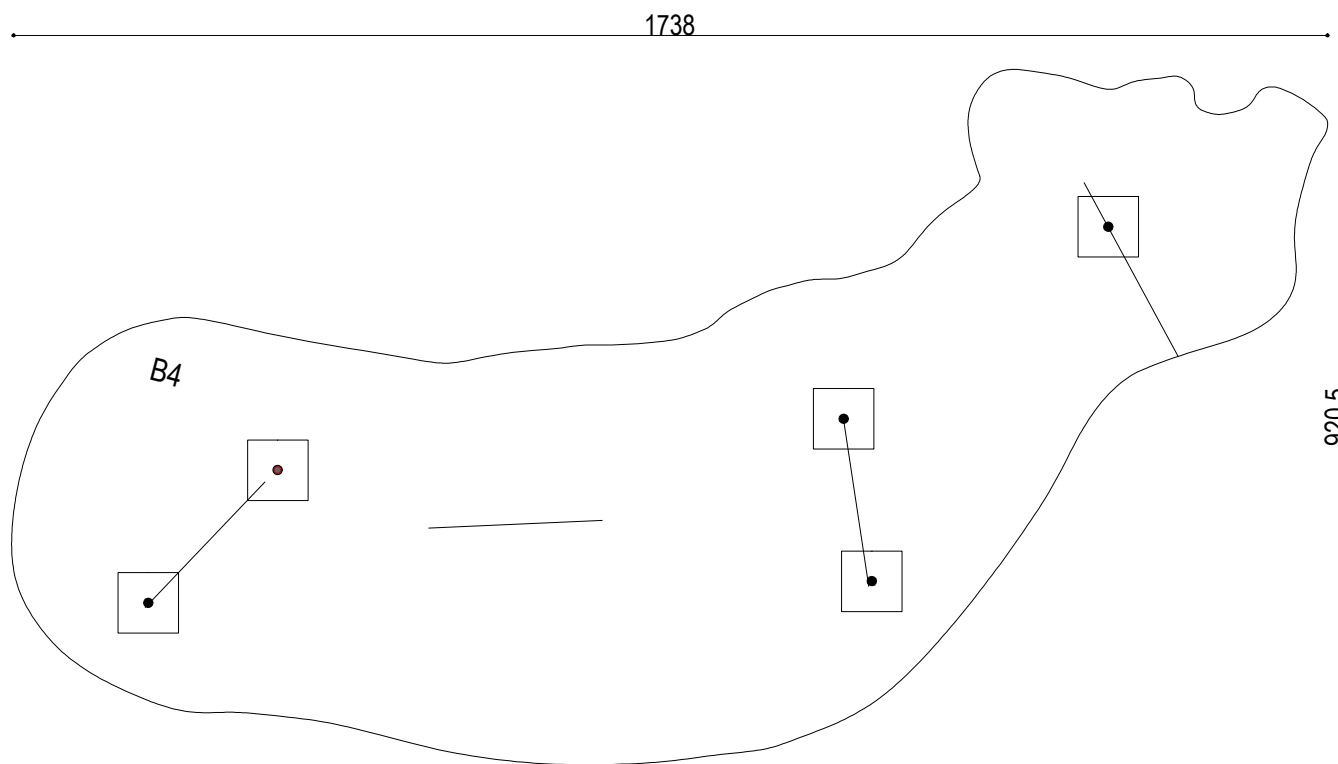
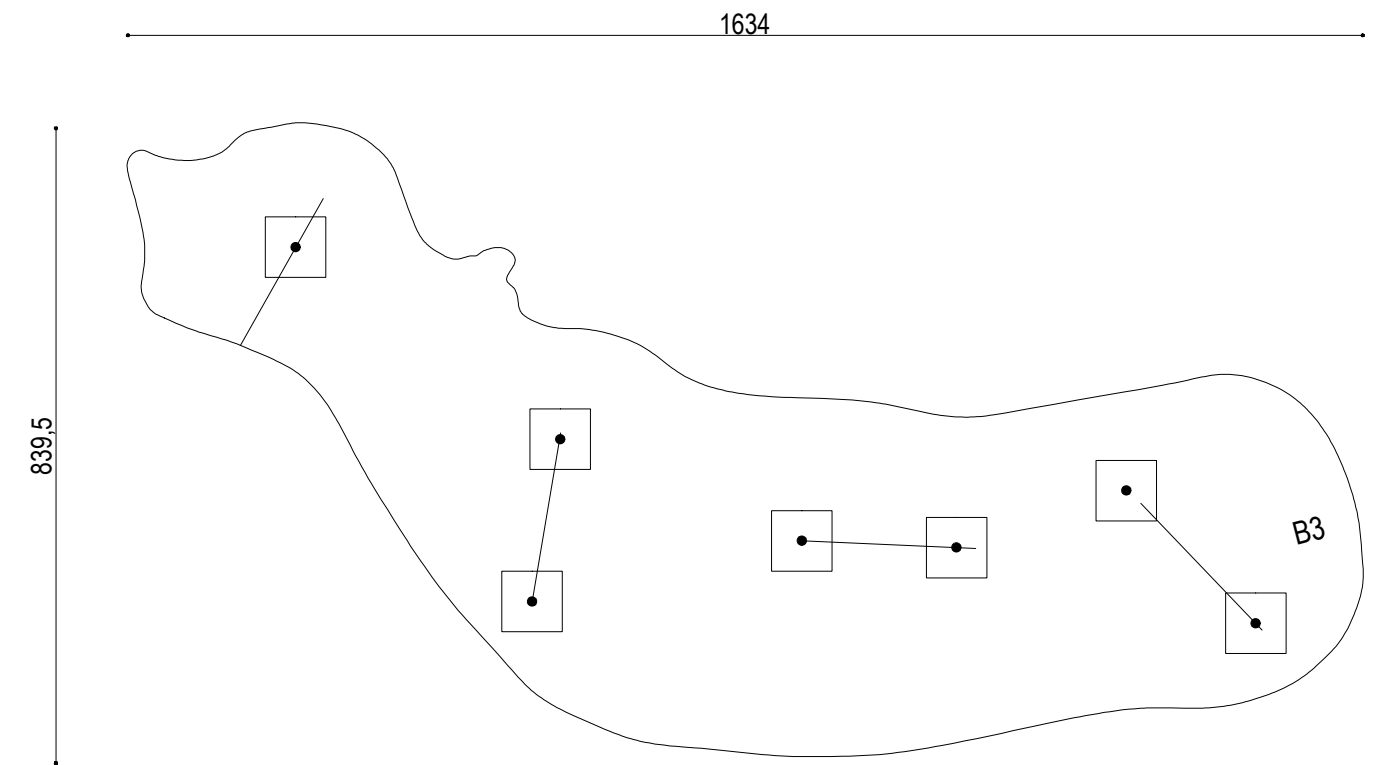
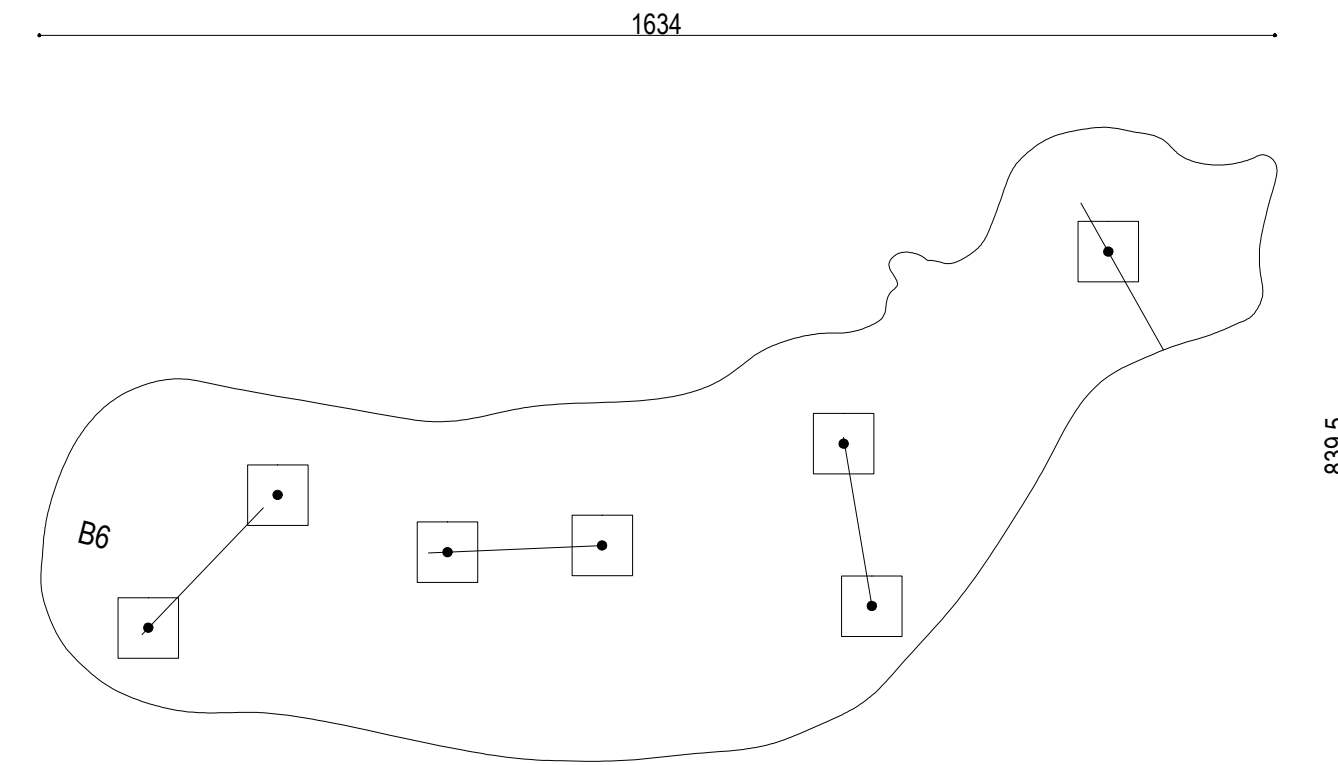

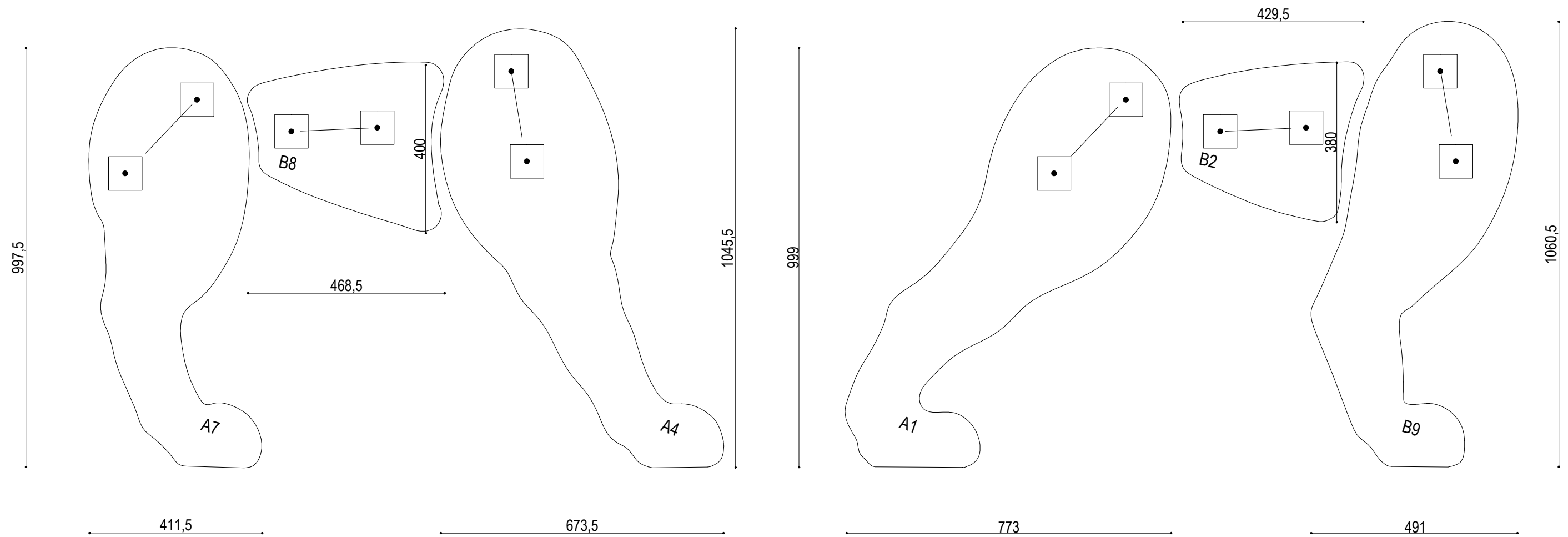

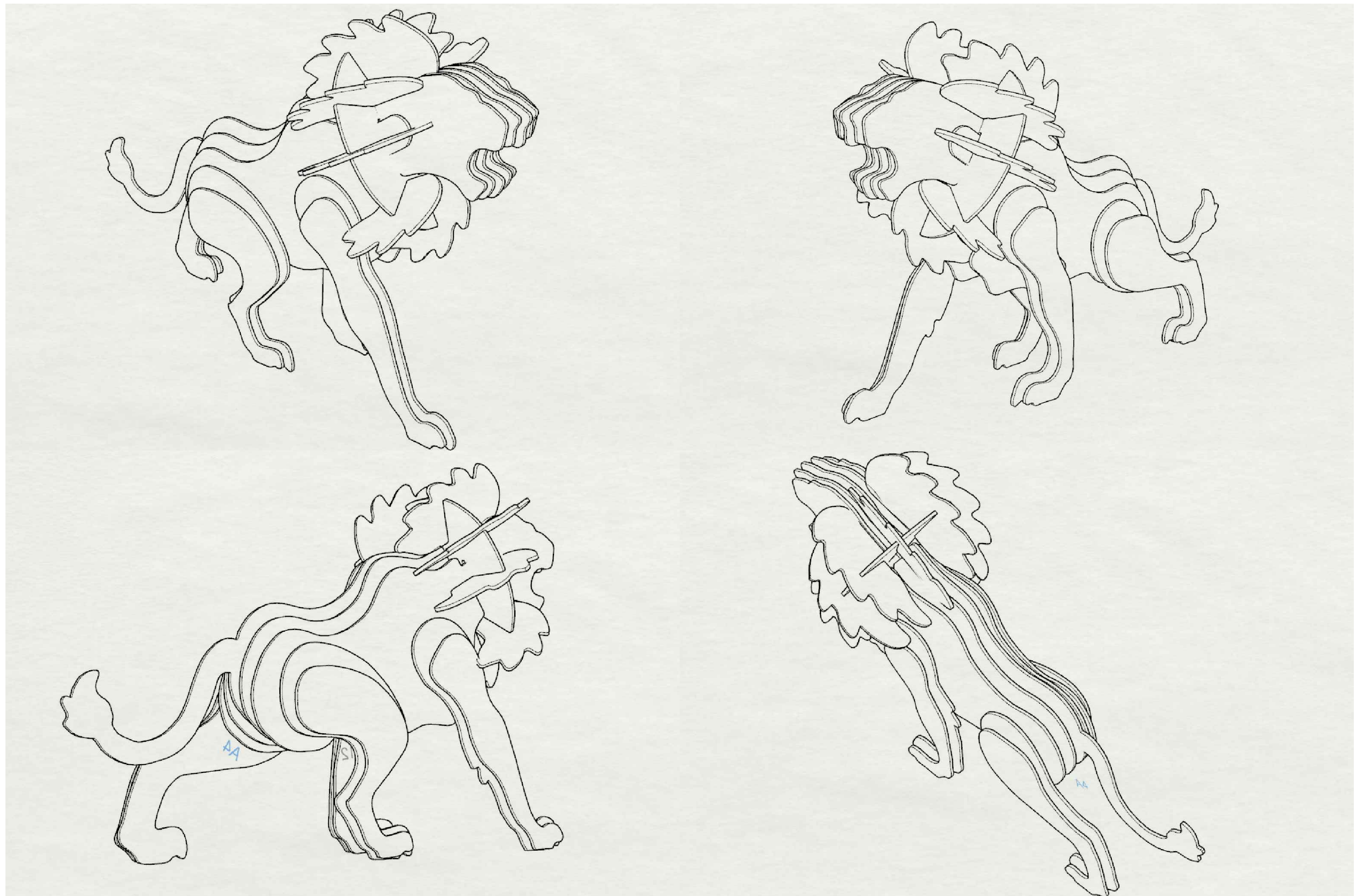

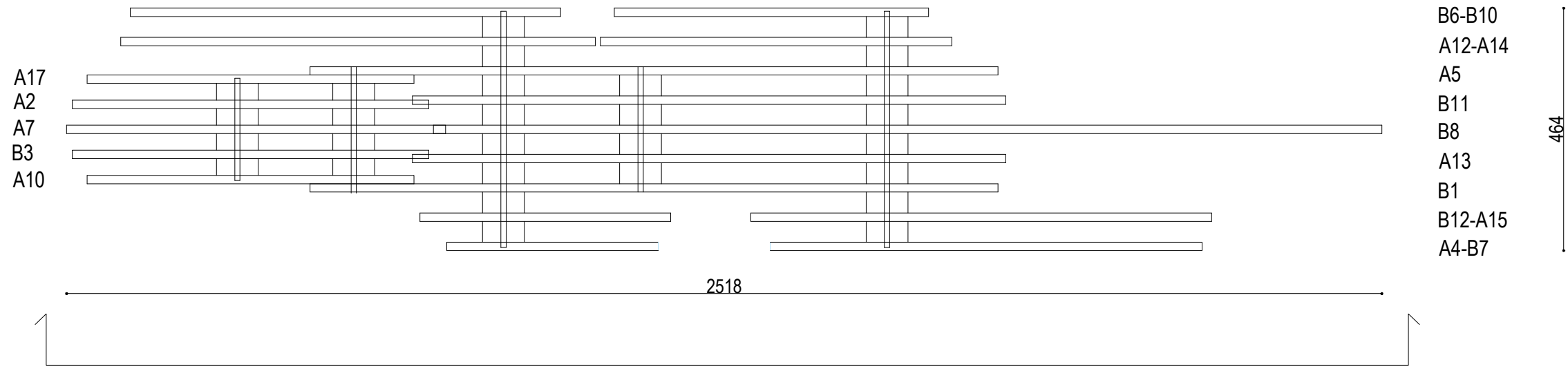

PIANTA

Prospetto A-A'

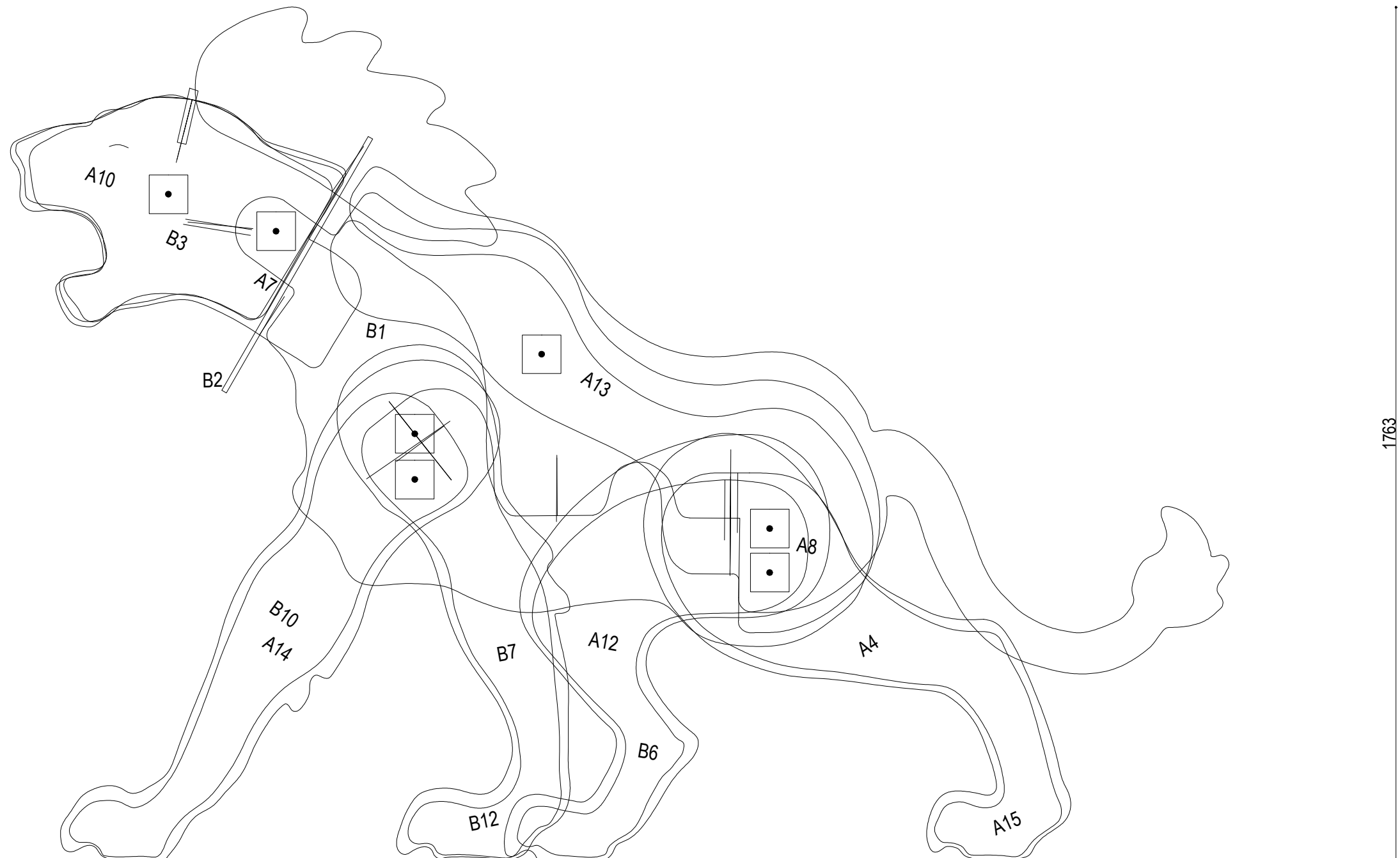

PROSPETTO A-A'

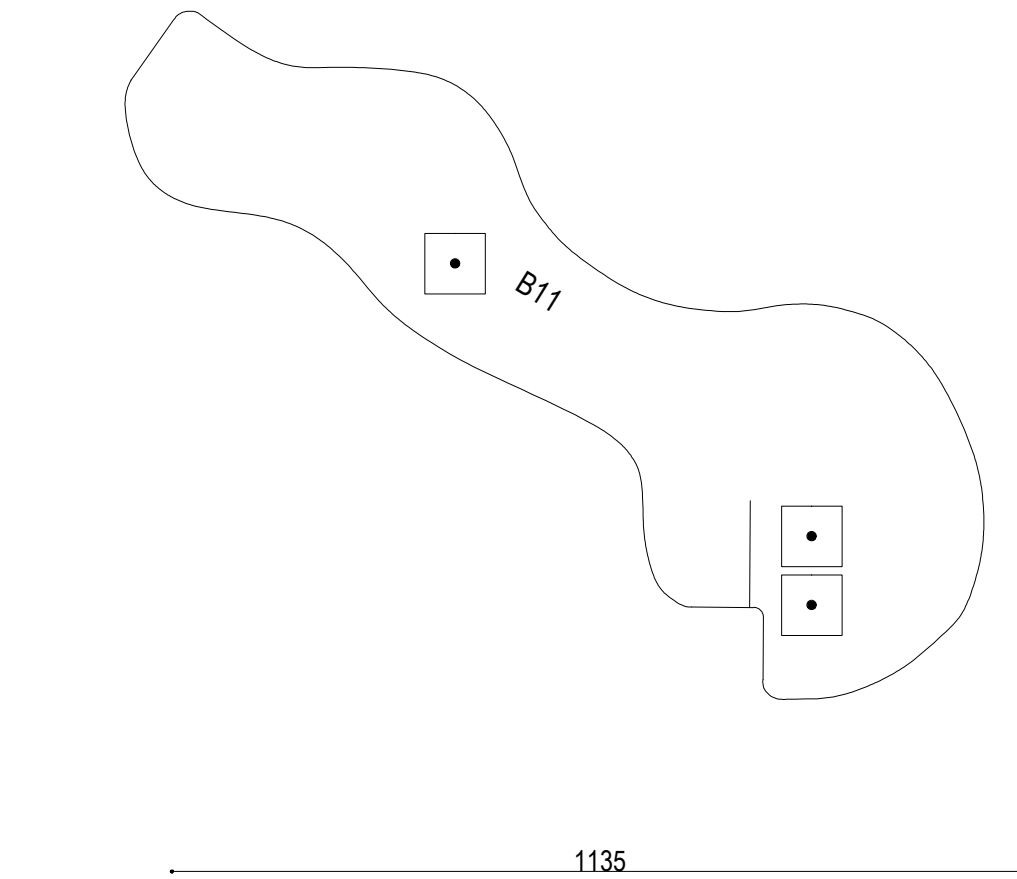
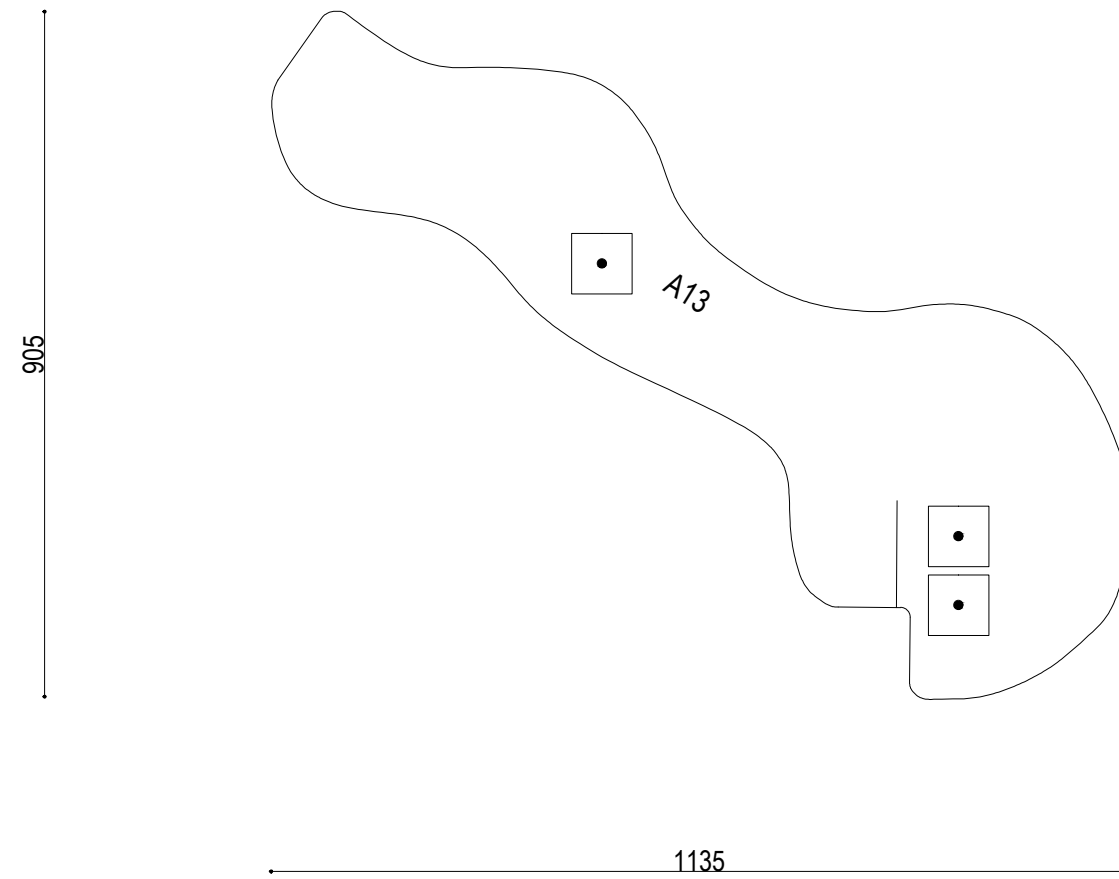
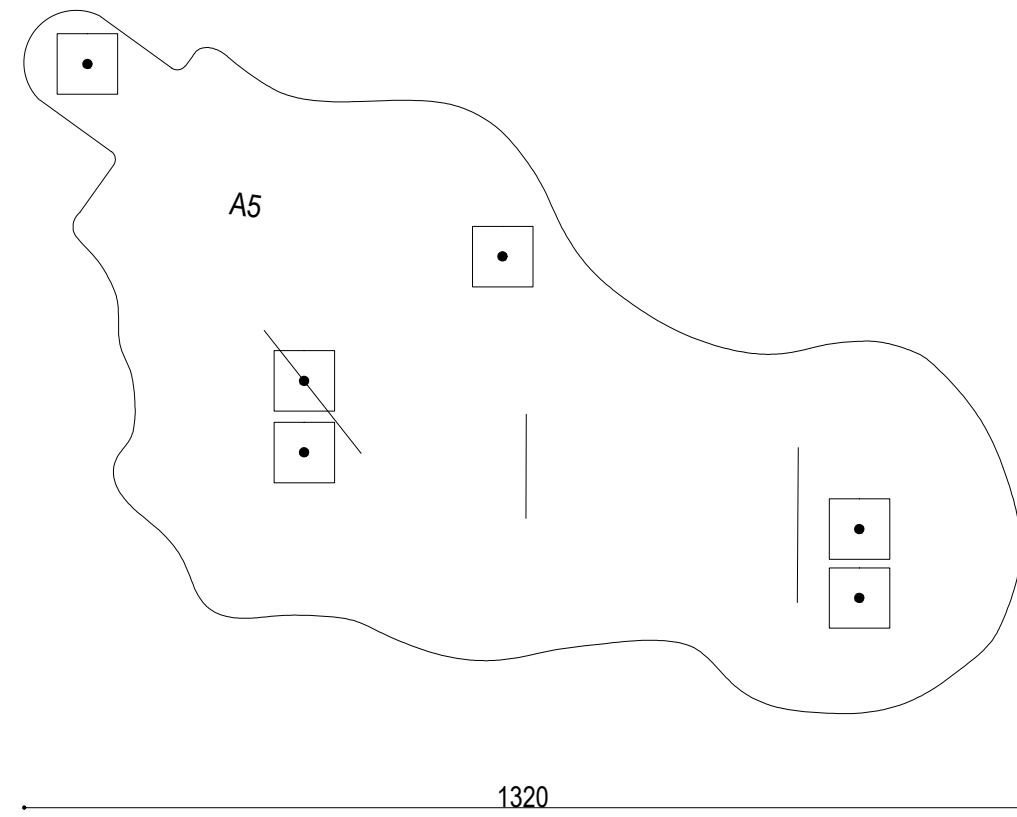
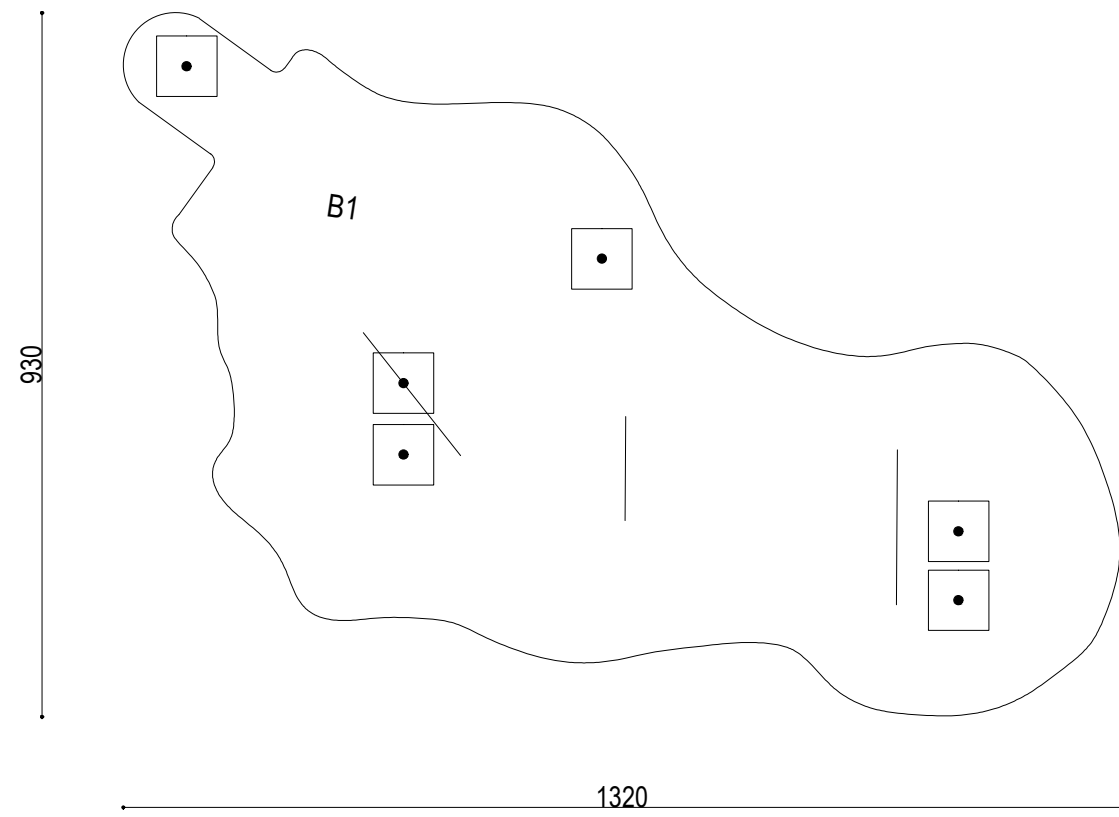

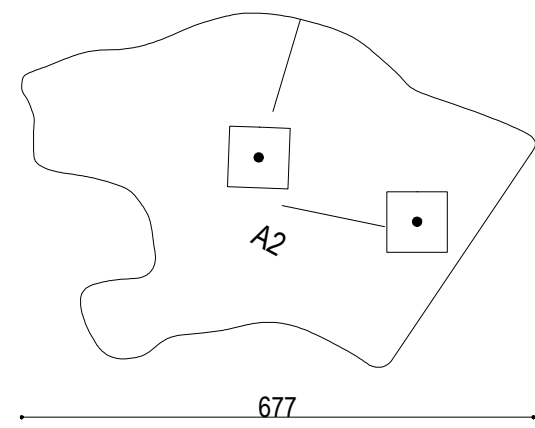
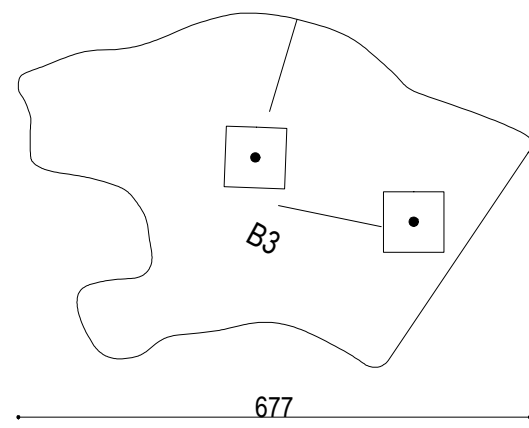
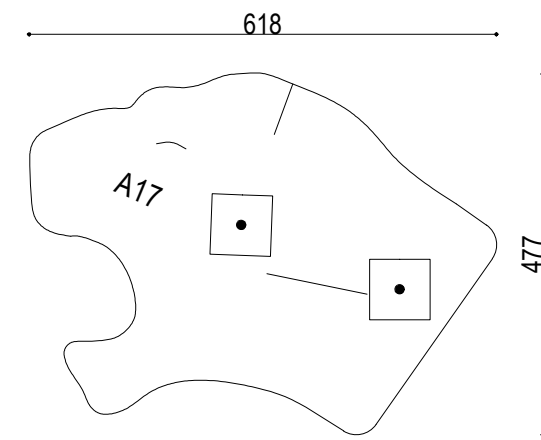
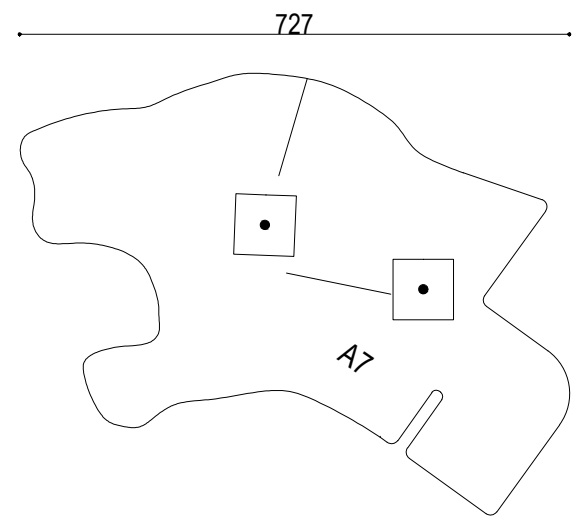
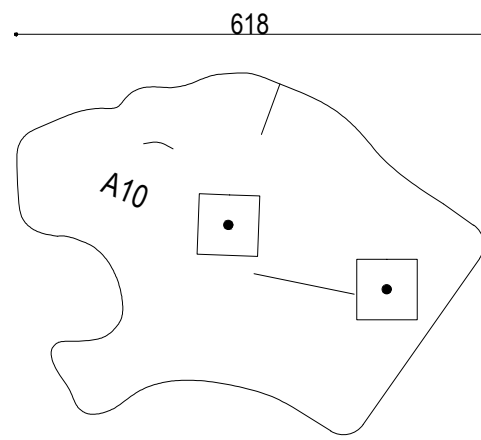
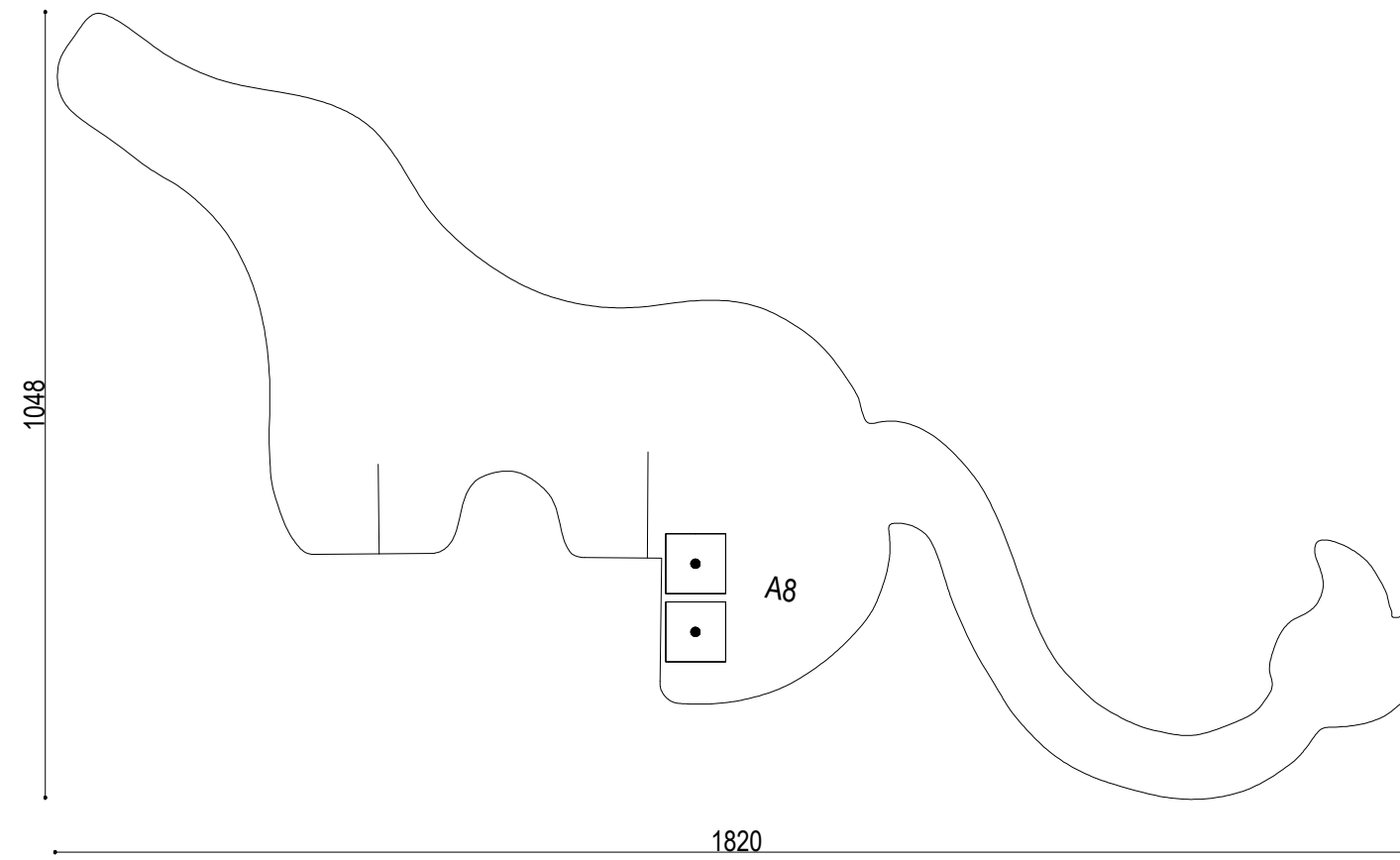

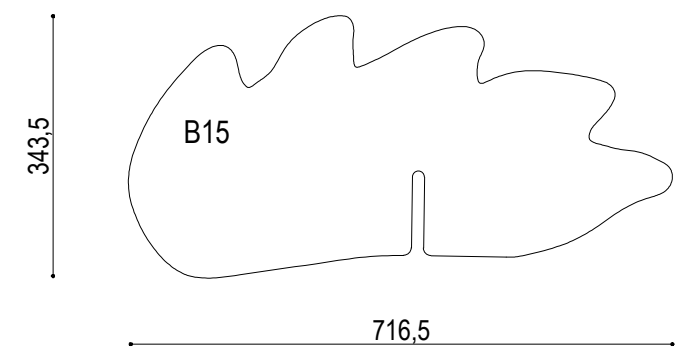
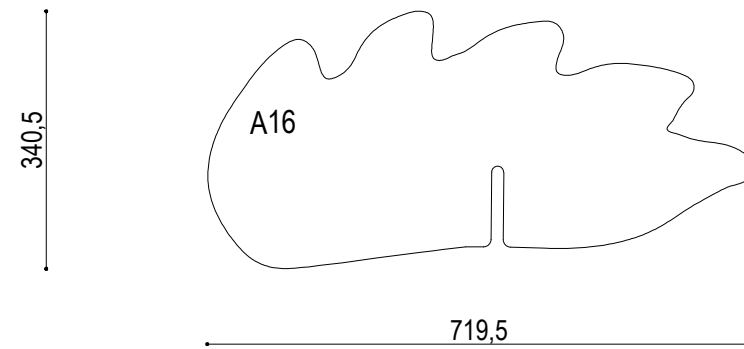
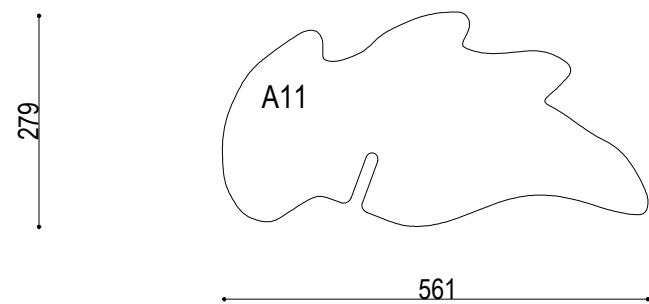
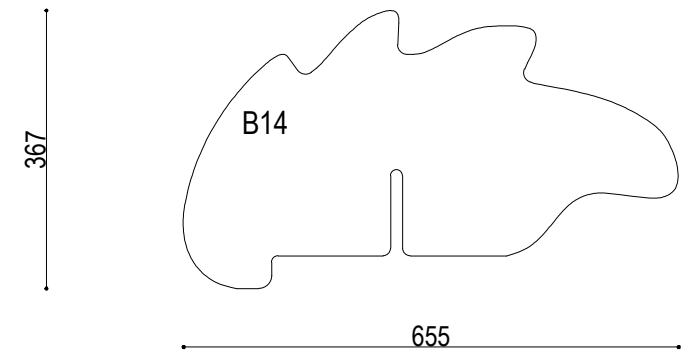
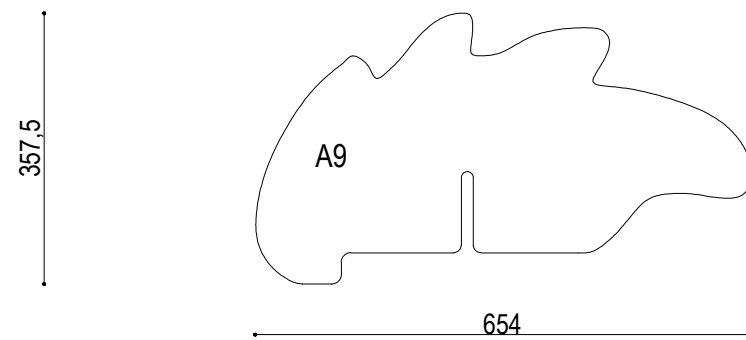
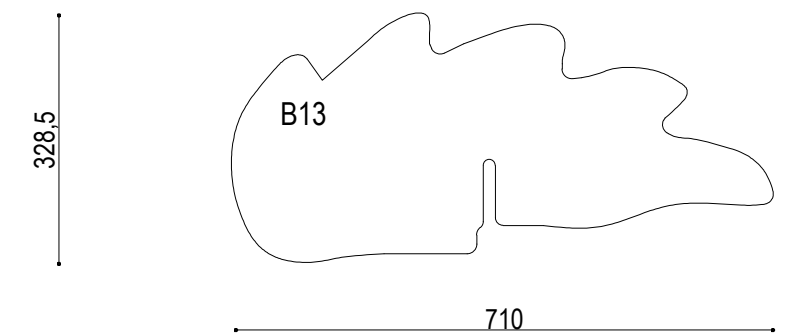
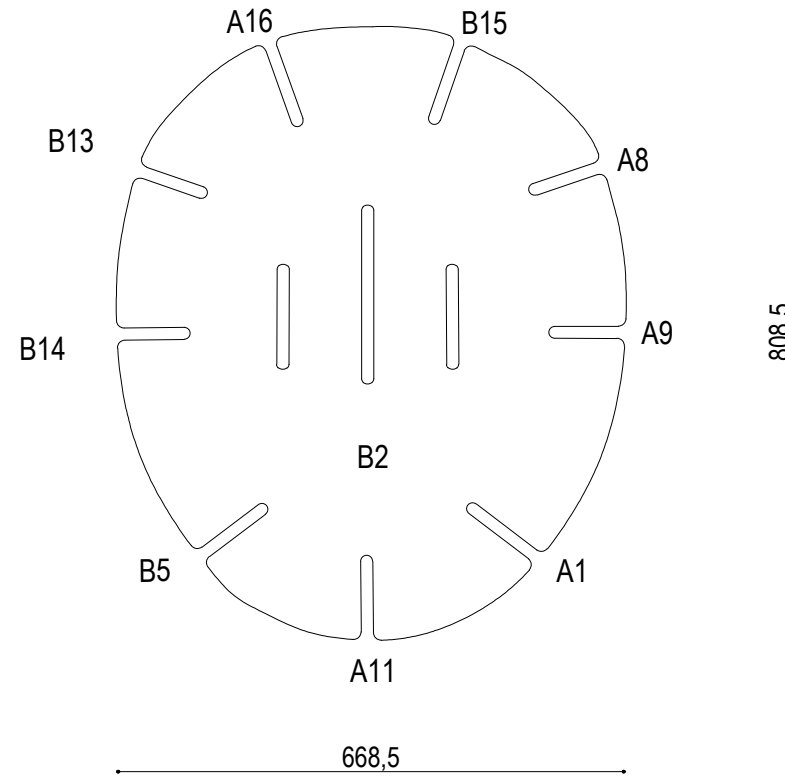
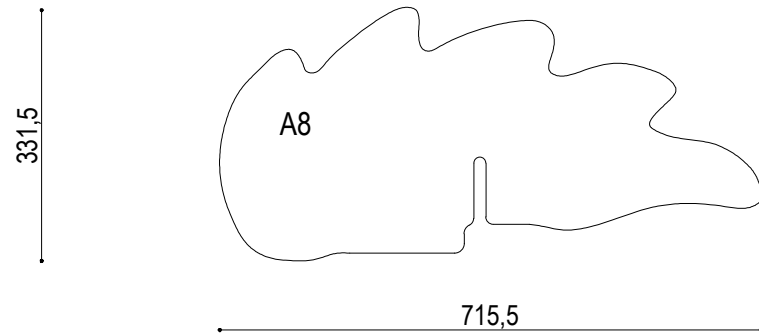
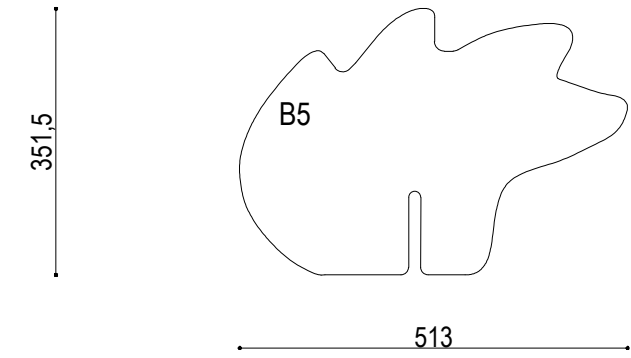
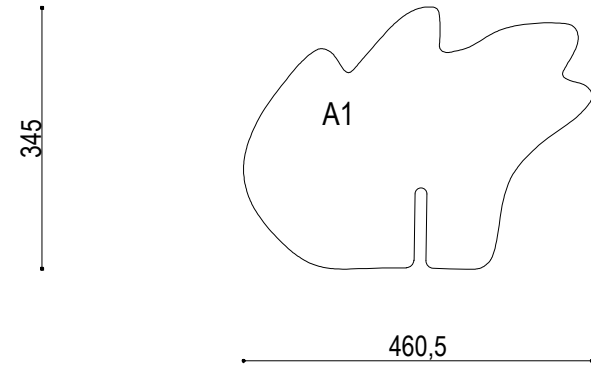

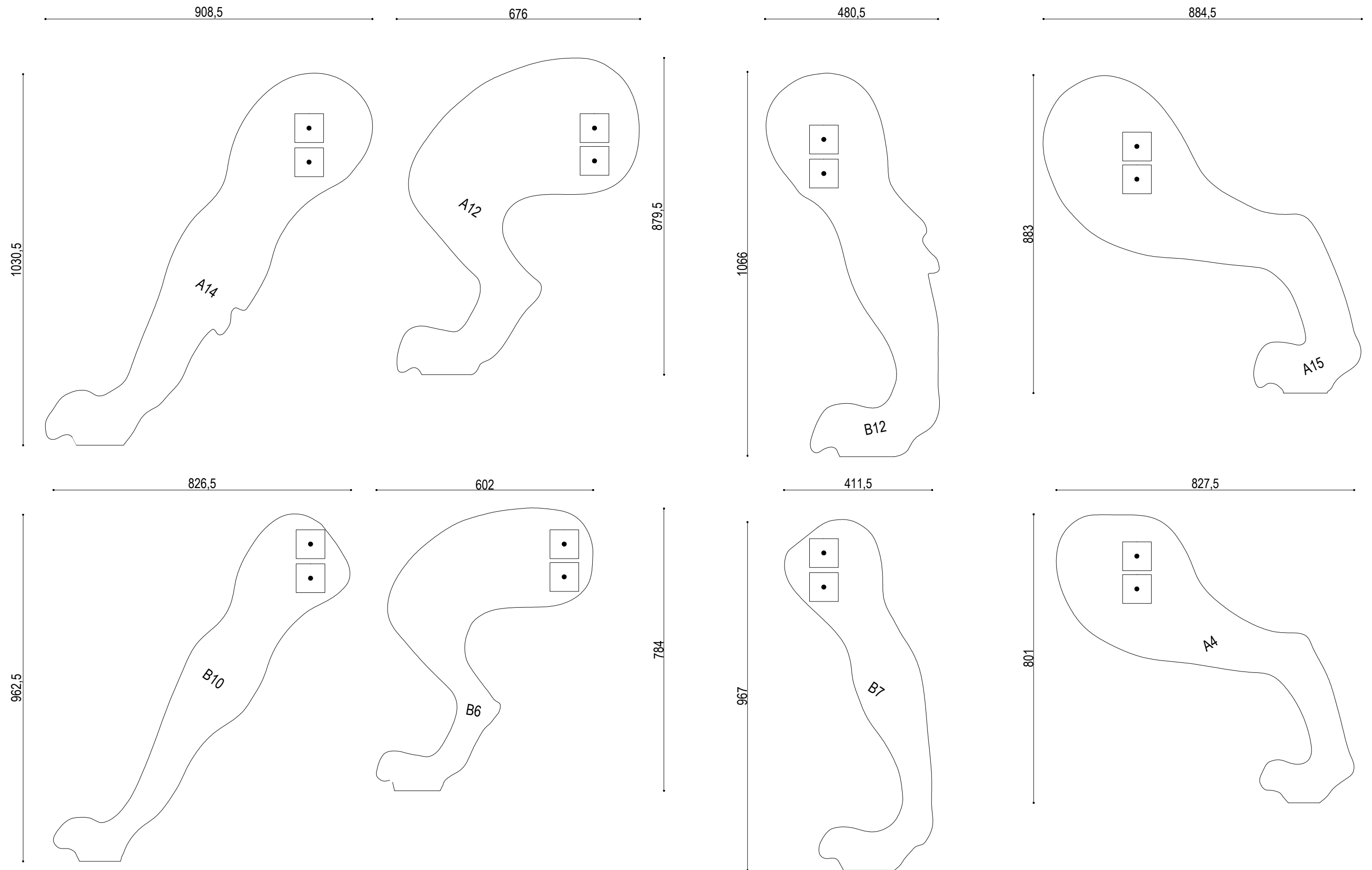

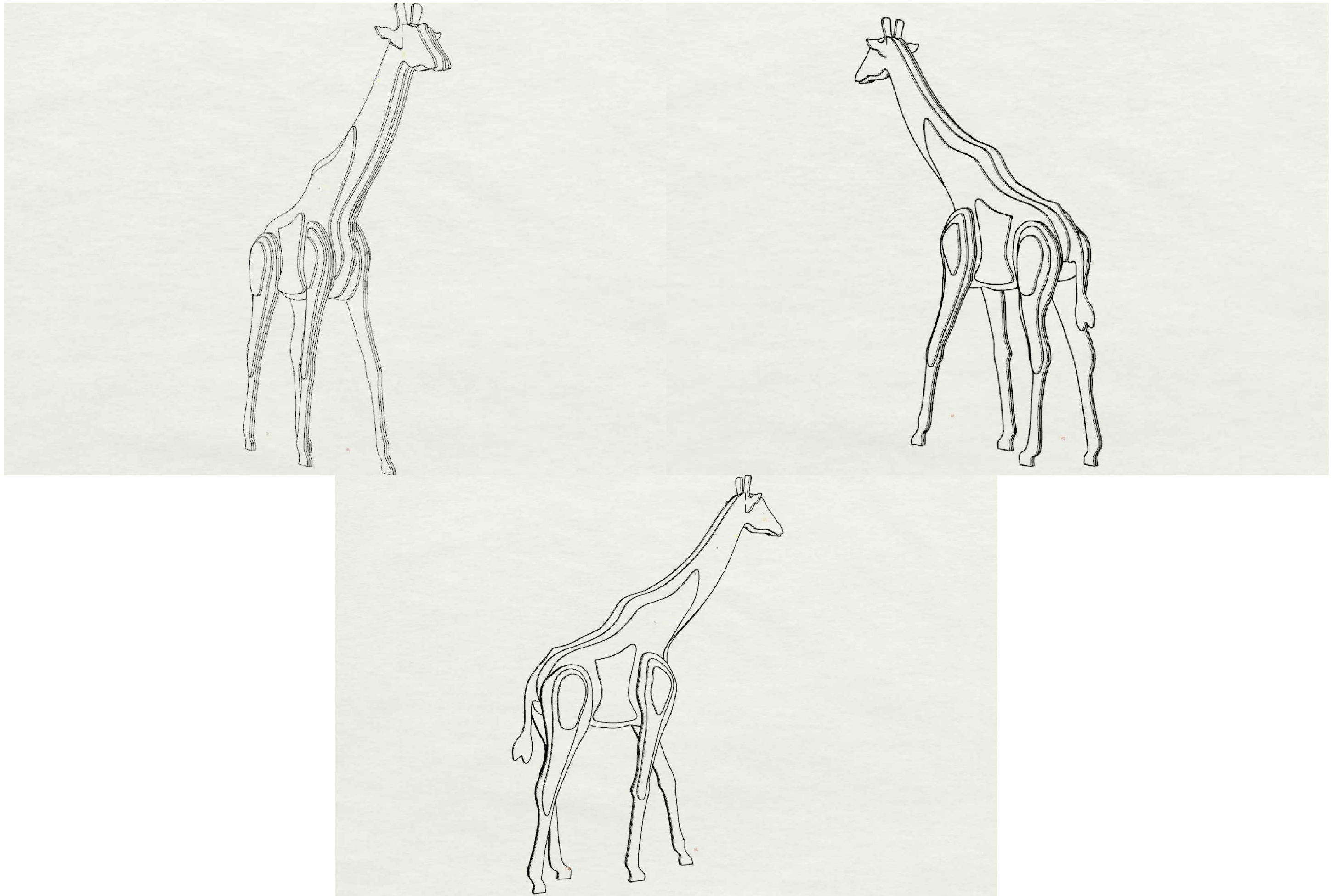

PIANTA

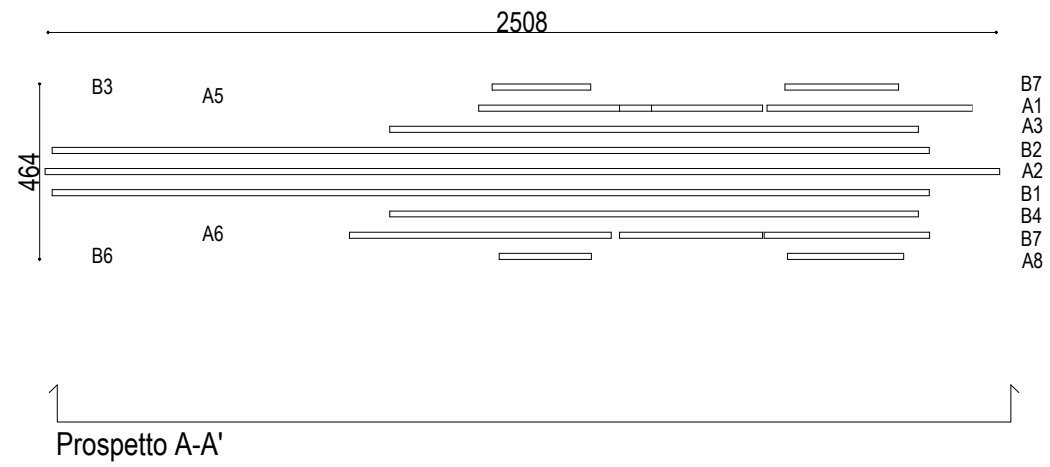

PROSPETTO A-A'

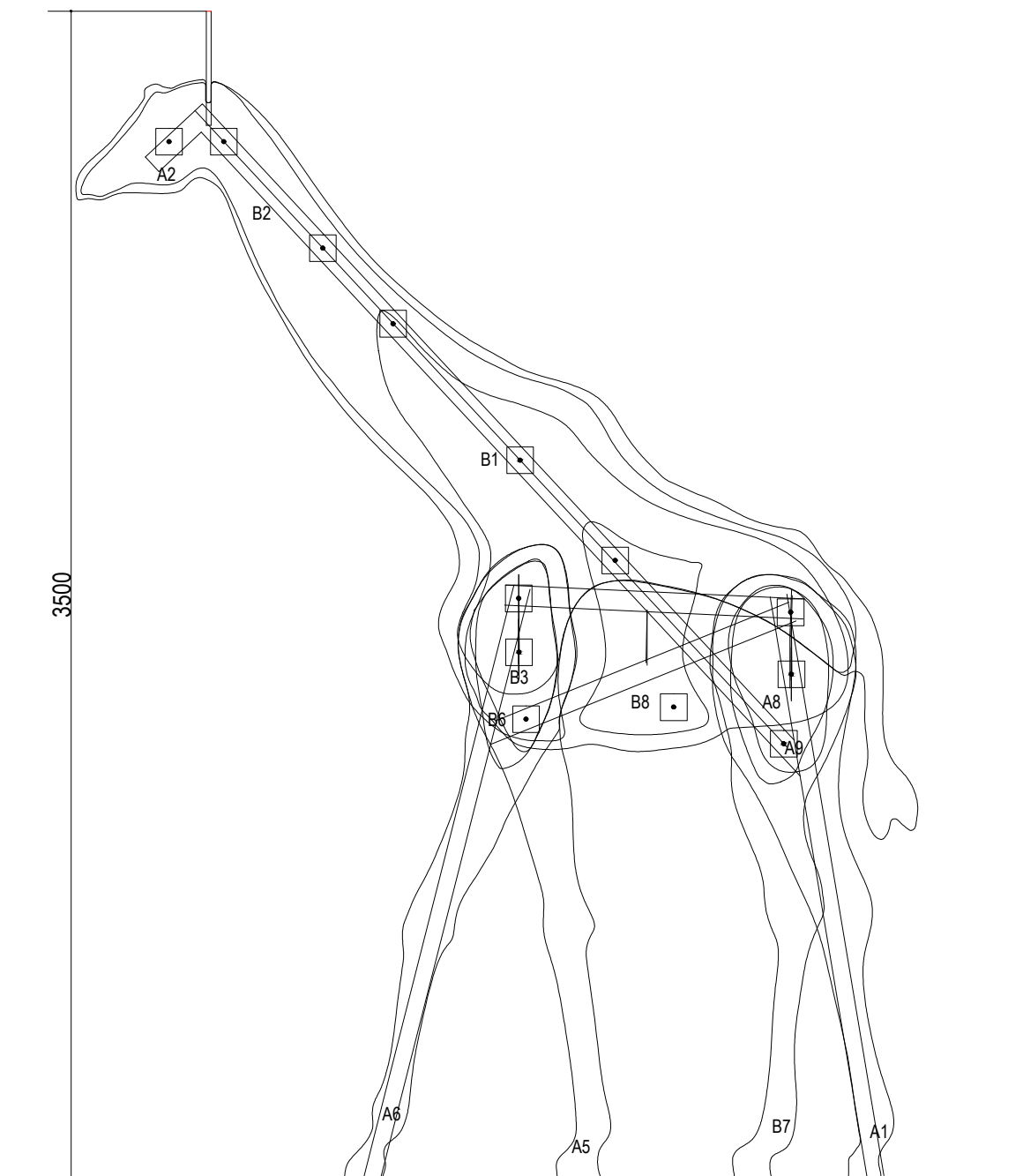

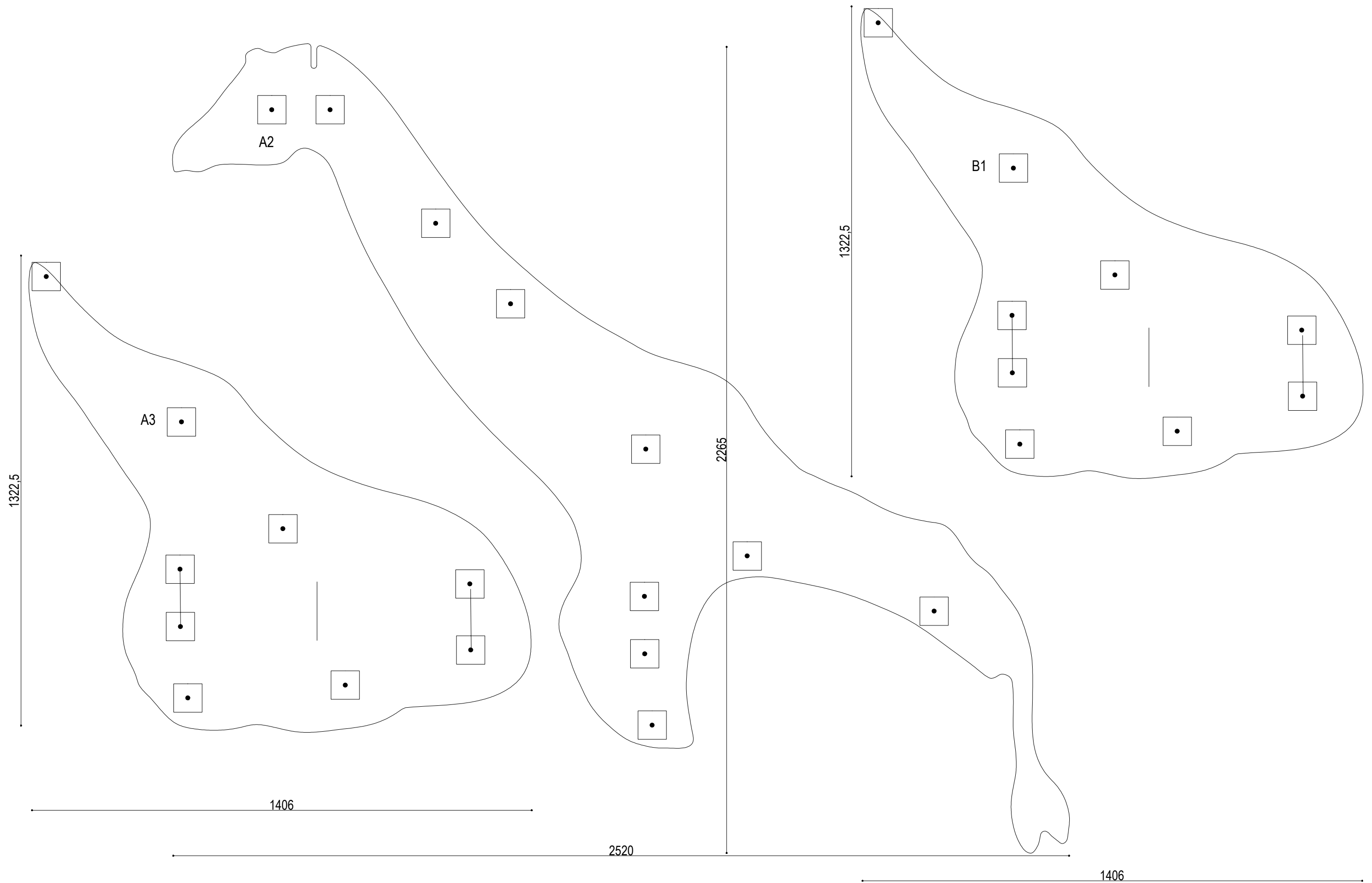

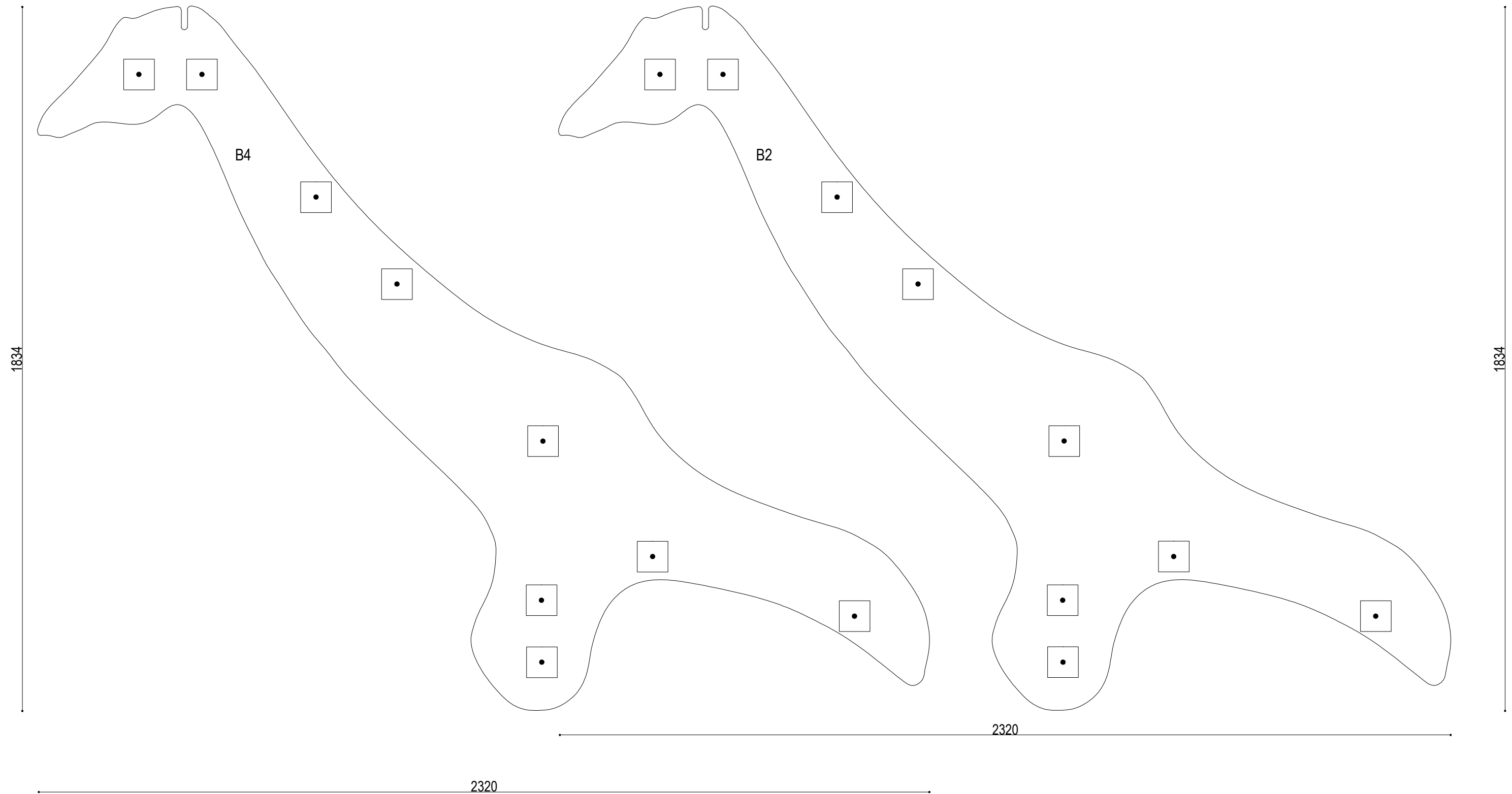

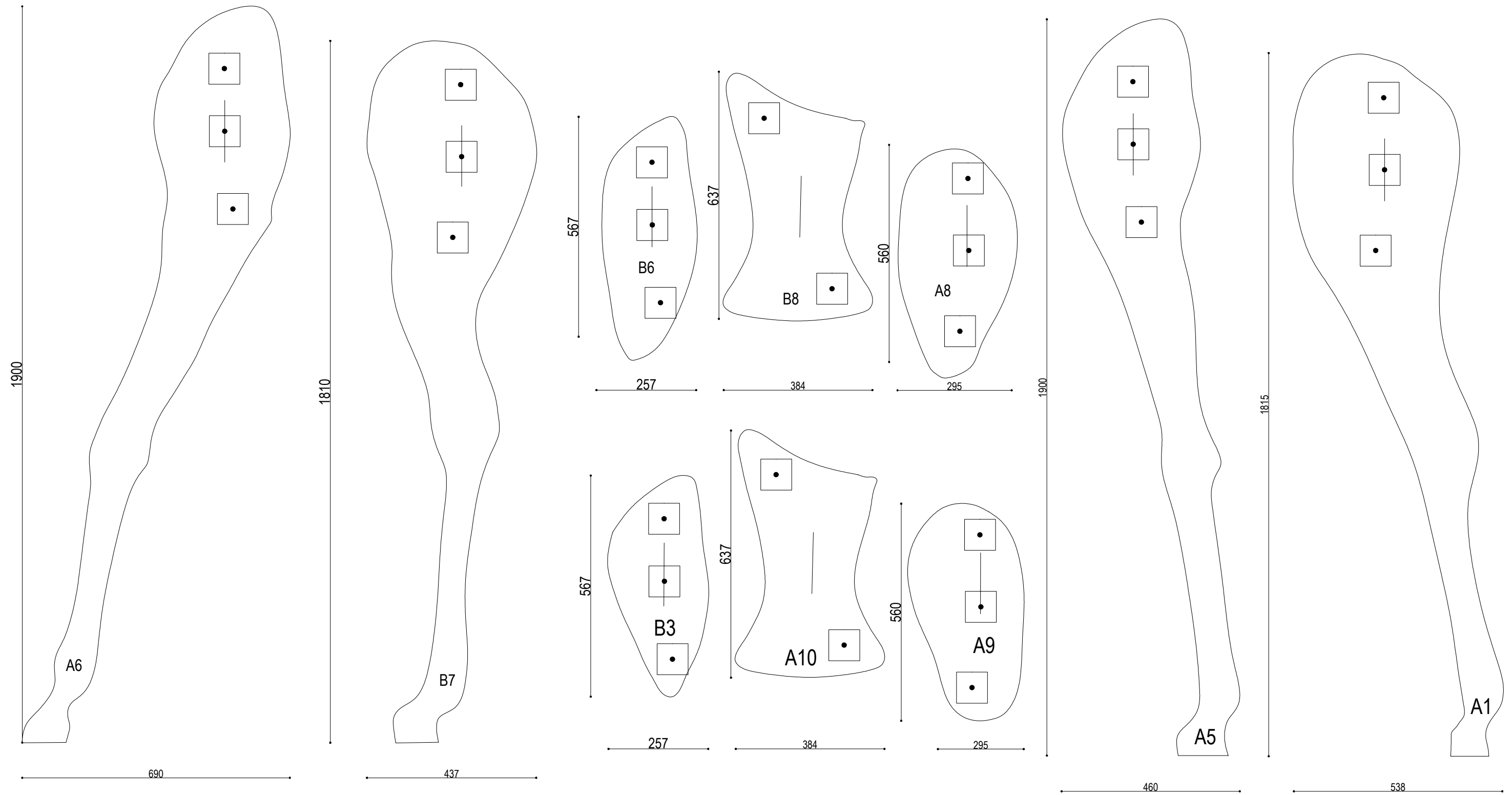

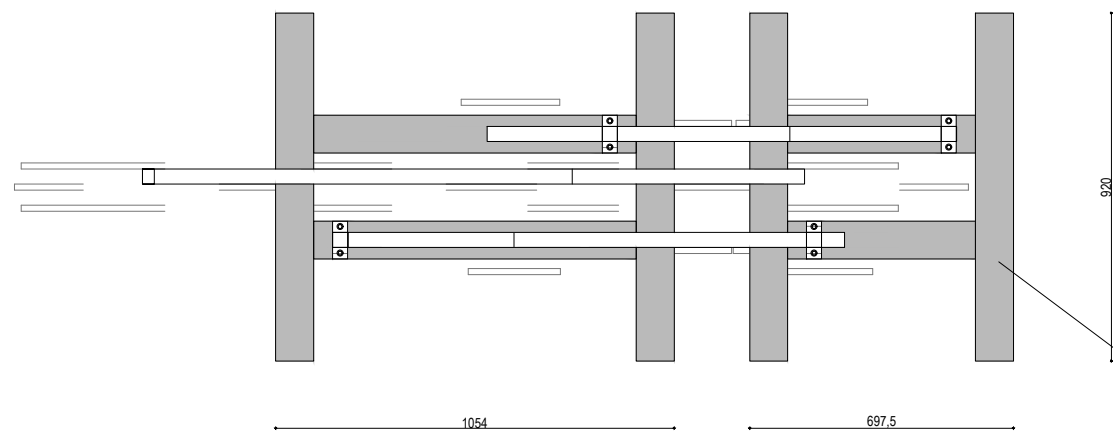
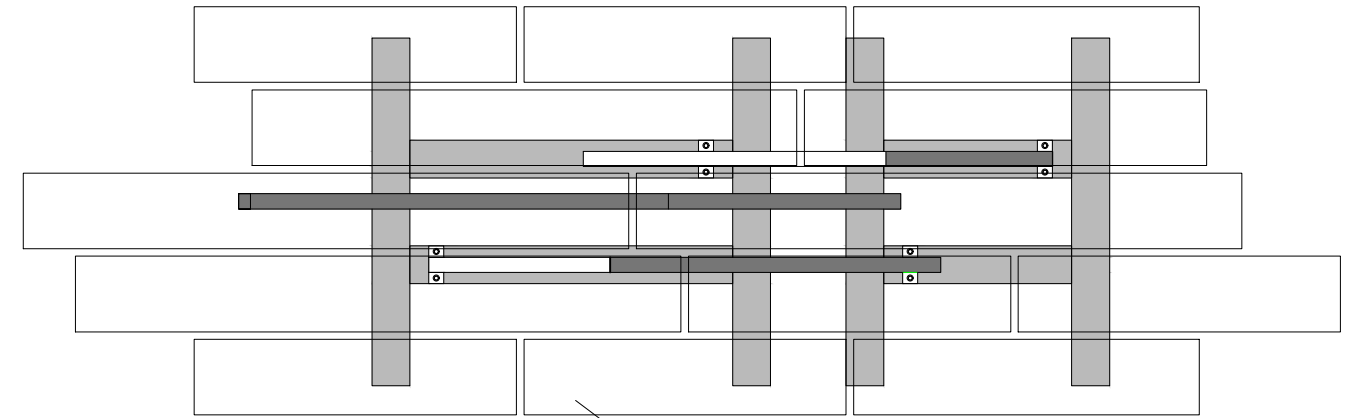
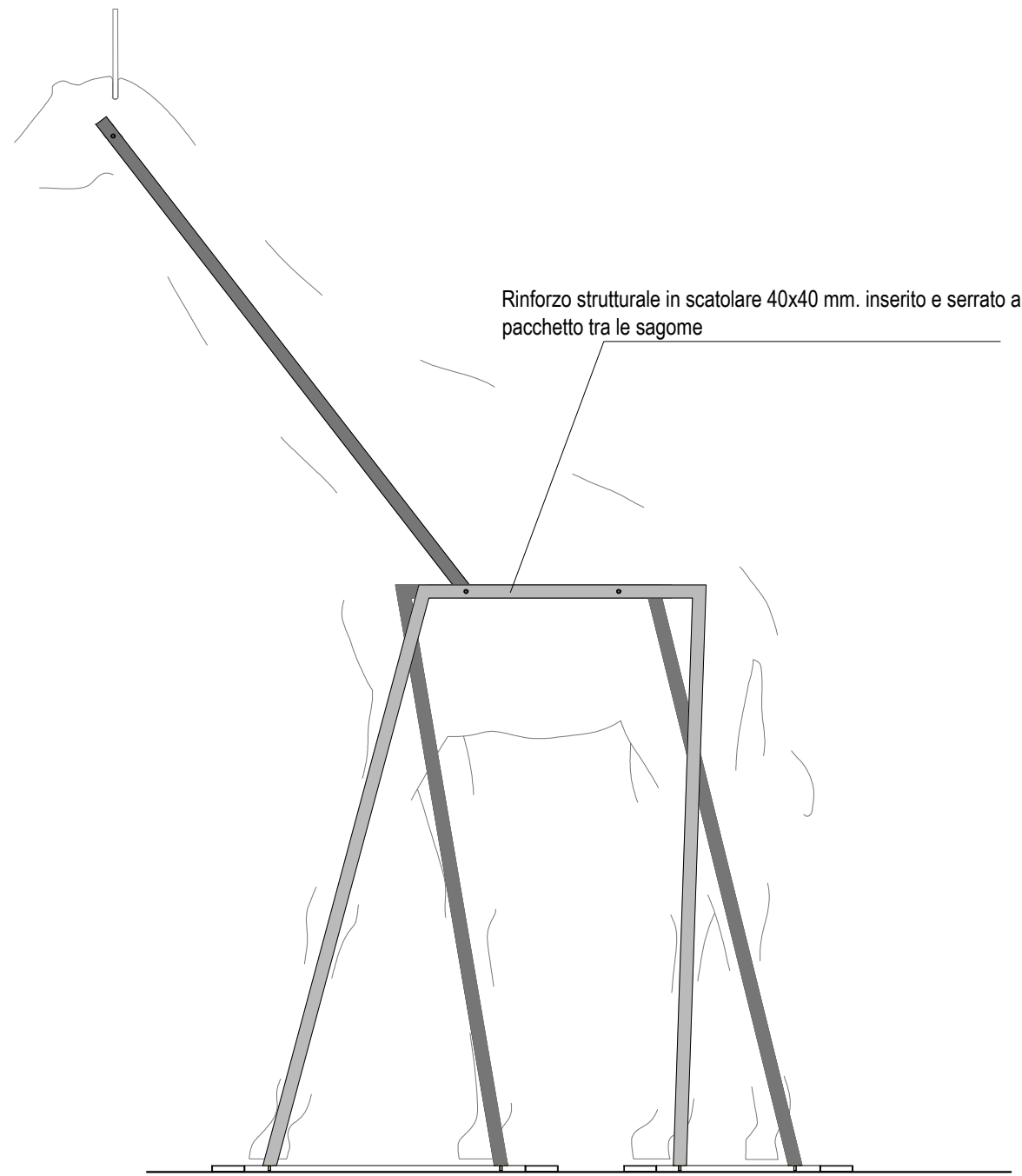

Telaio di fissaggio e anti ribaltamento

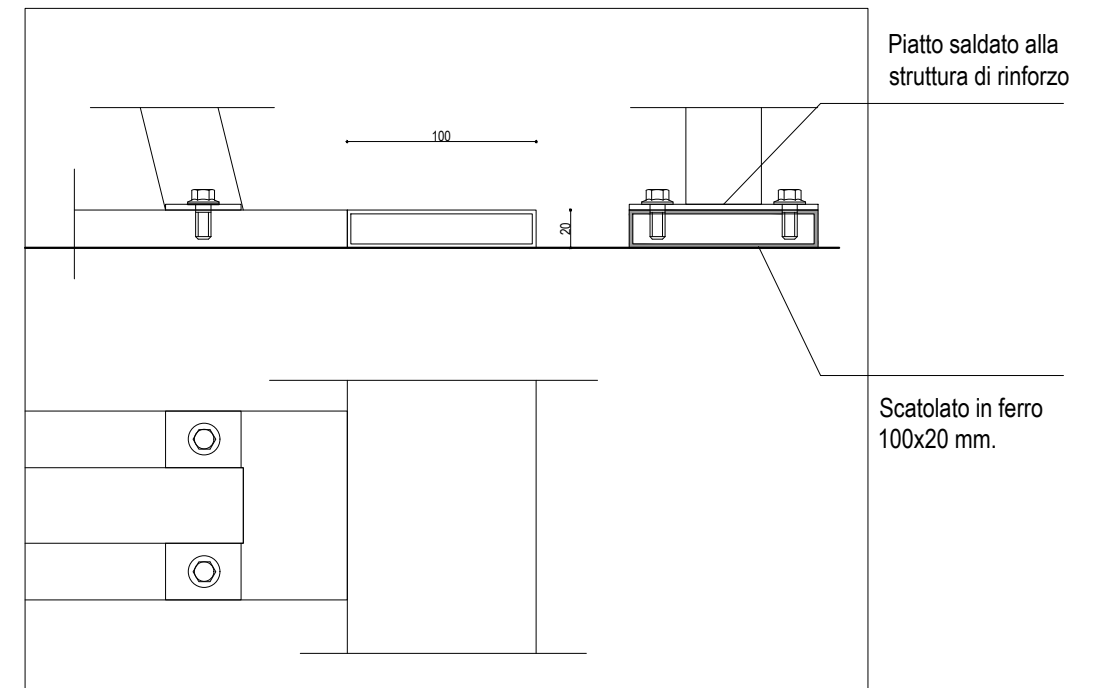

DETTAGLIO ATTACCO-Scala 1:5

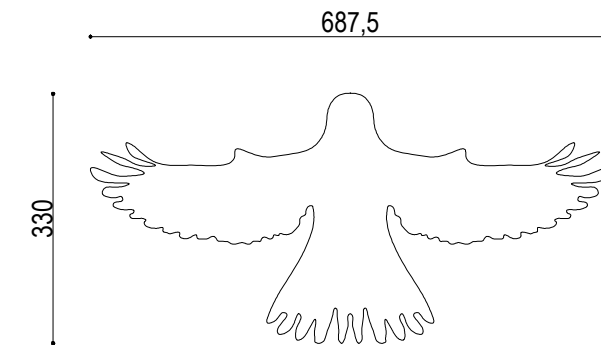
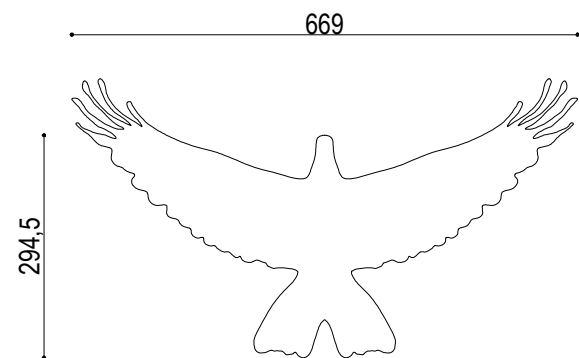
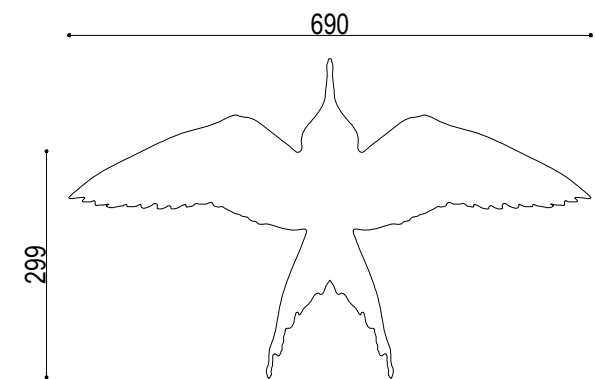
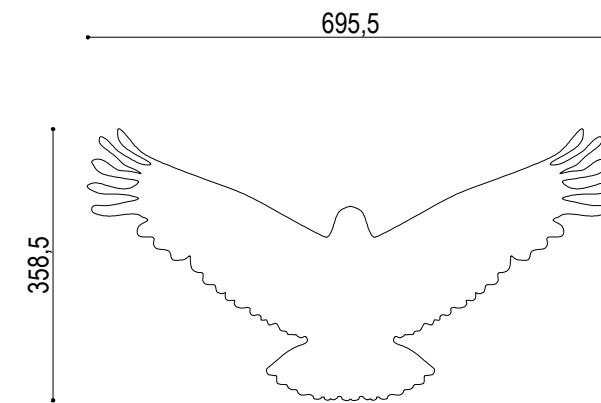
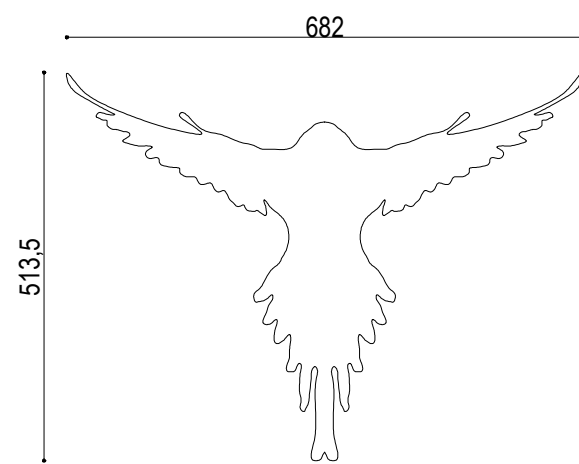
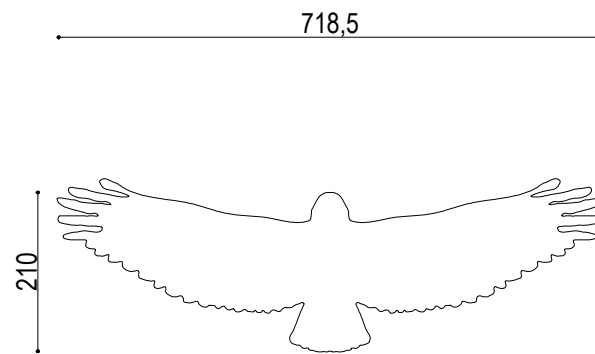
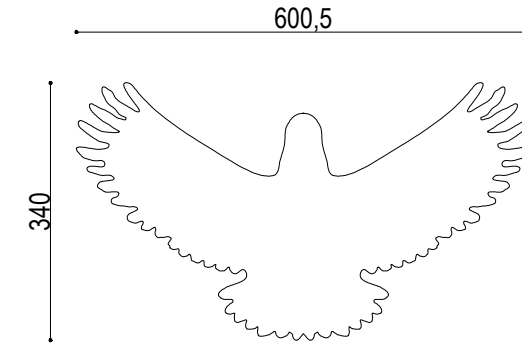
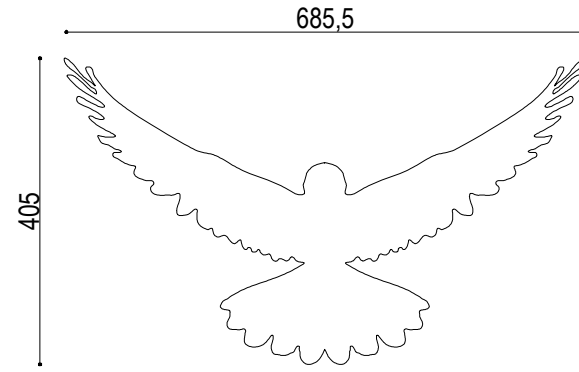
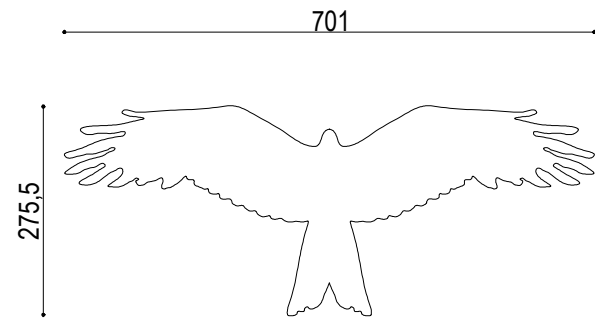

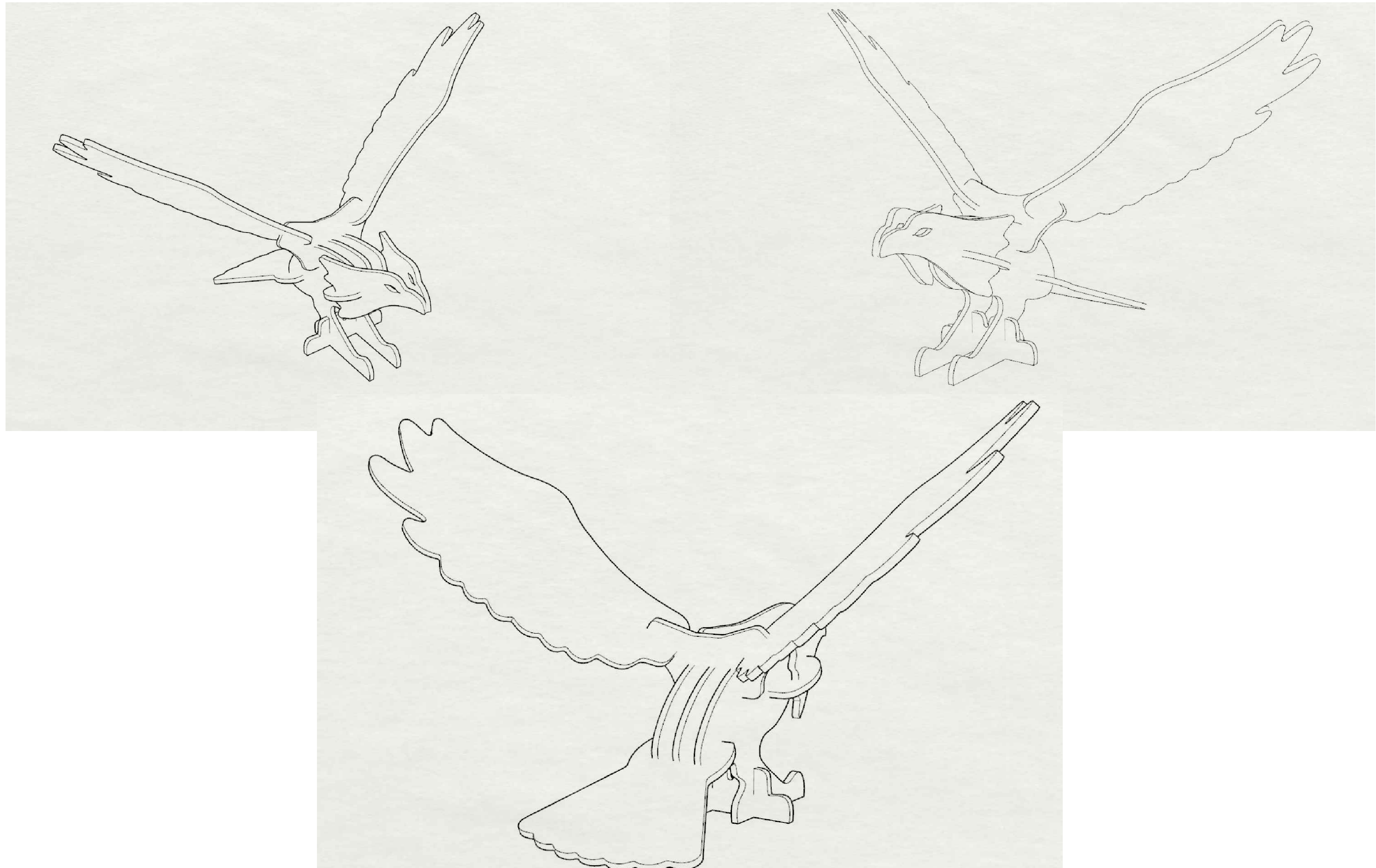

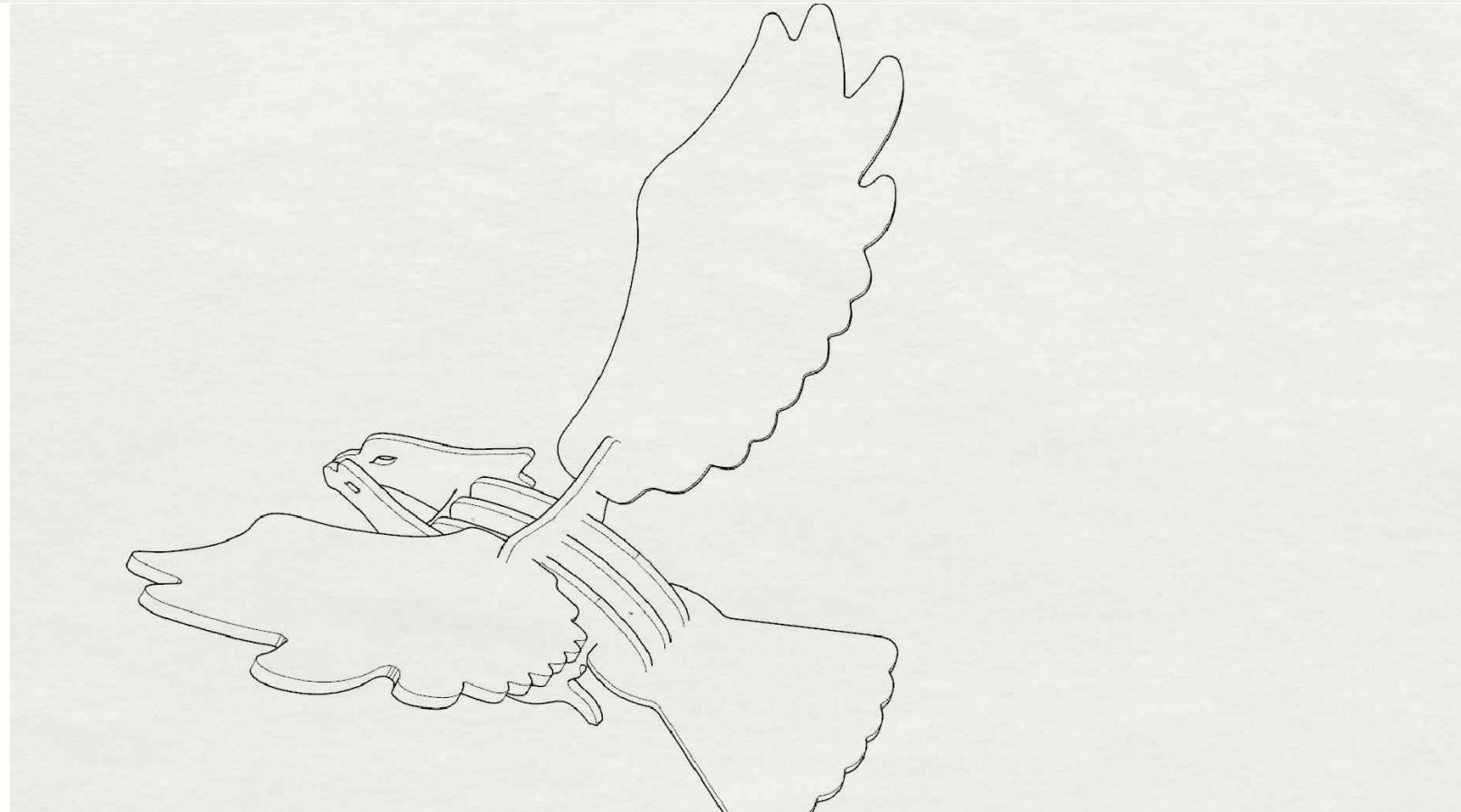
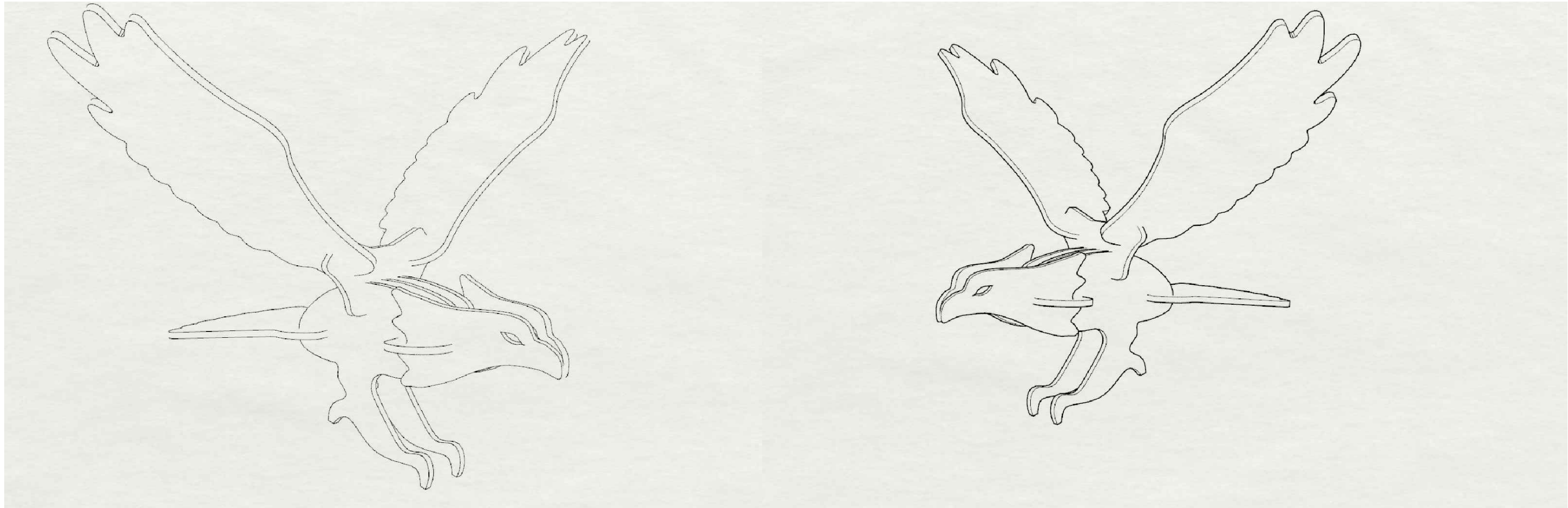

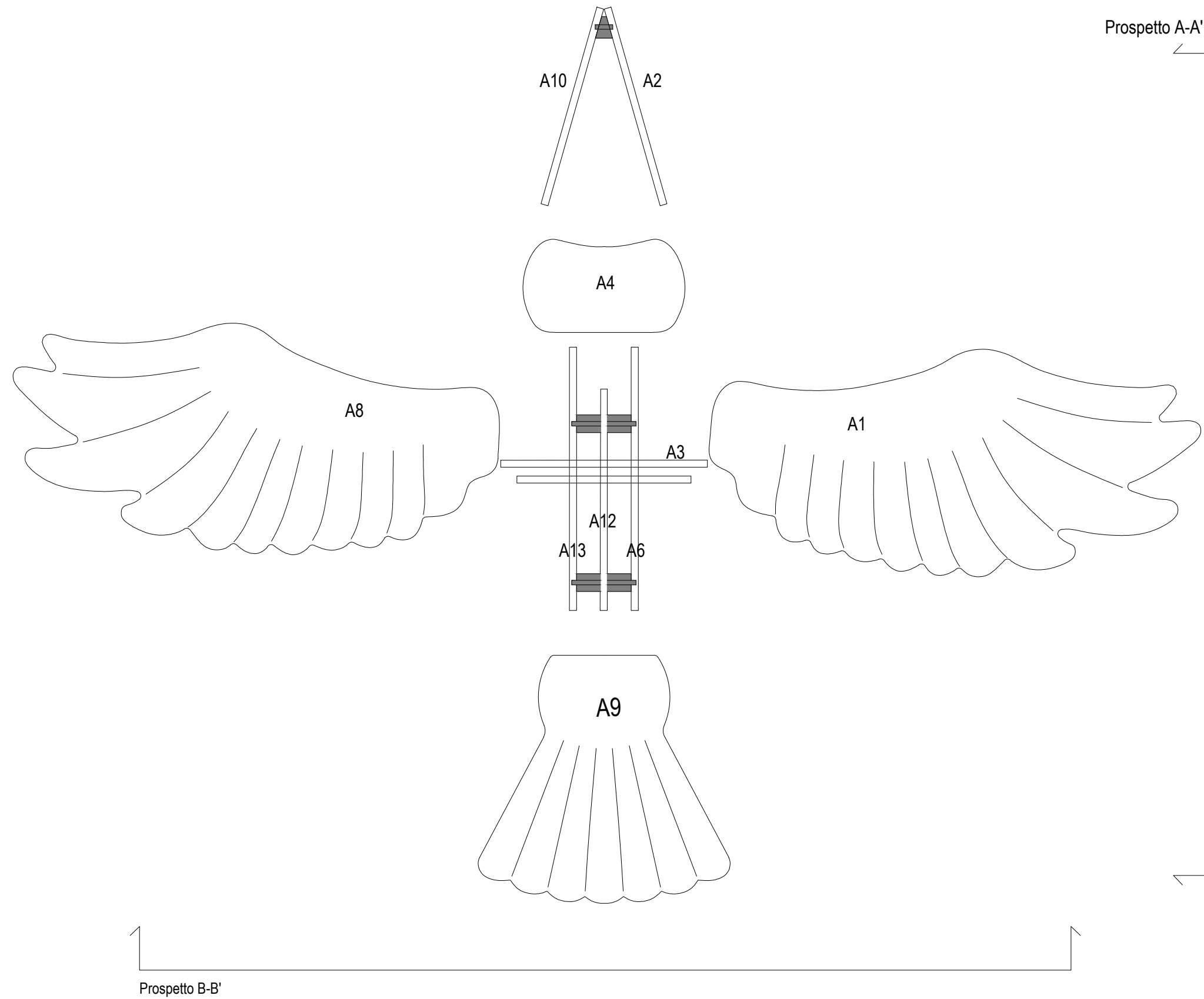

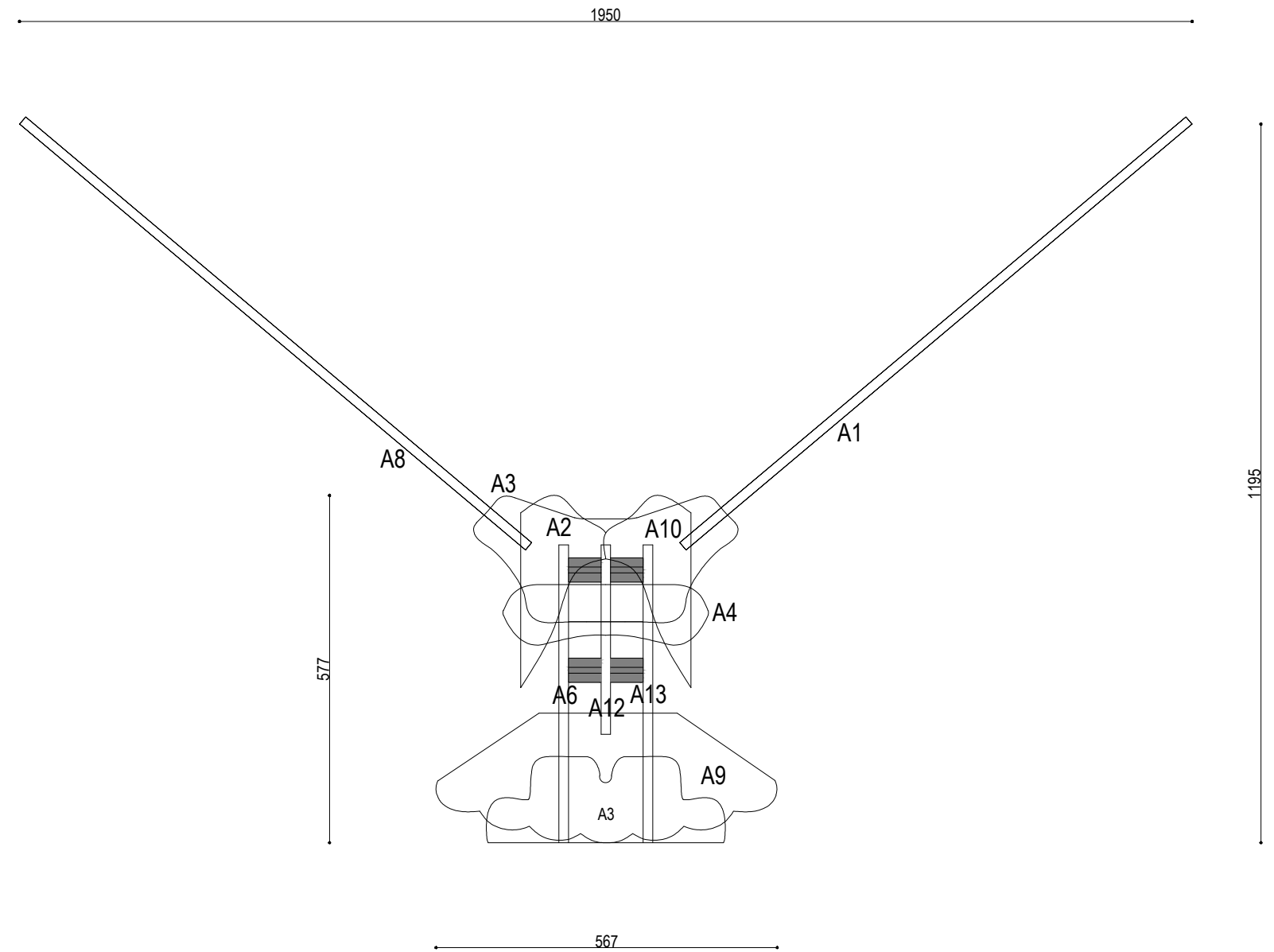
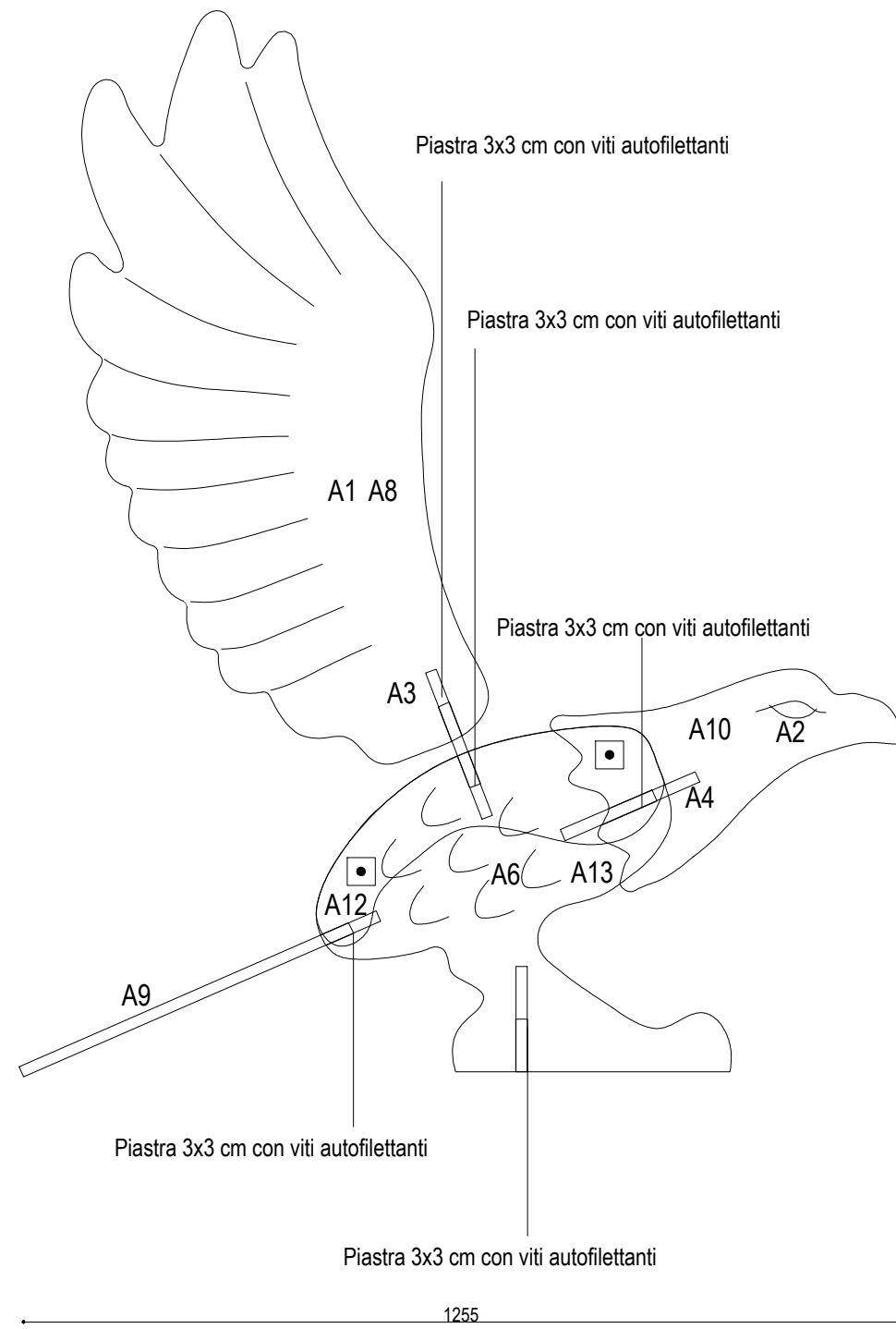

PROSPETTO A-A'

PROSPETTO B-B'

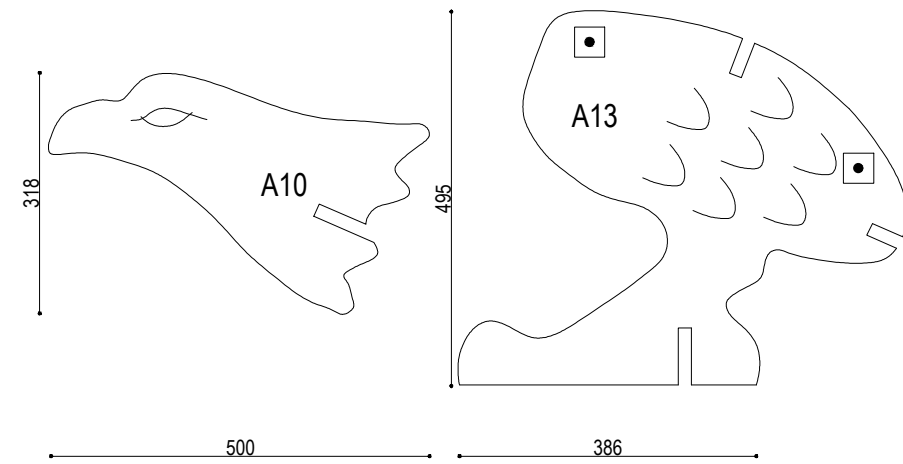
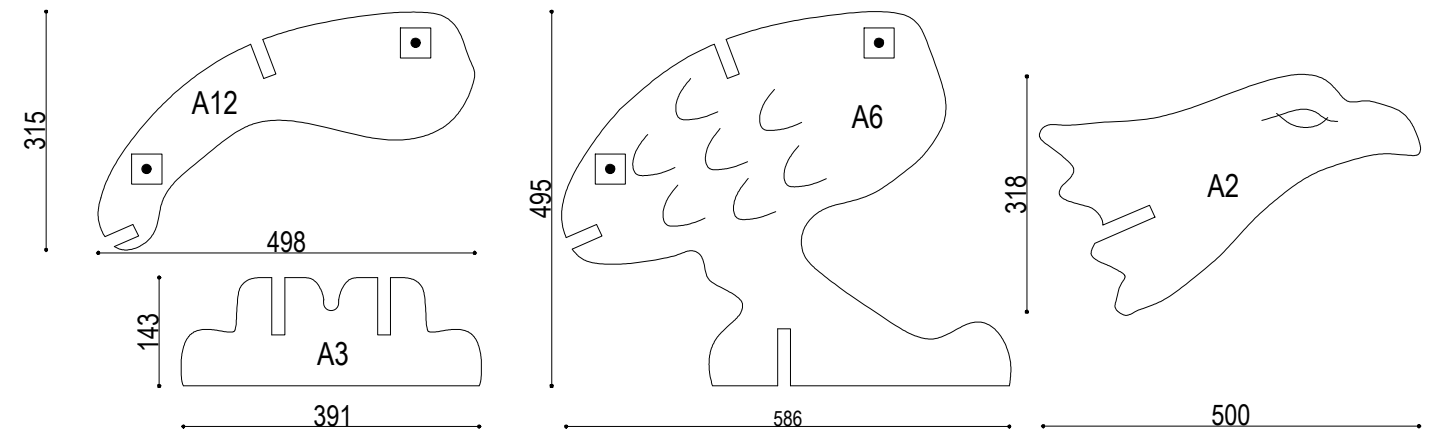
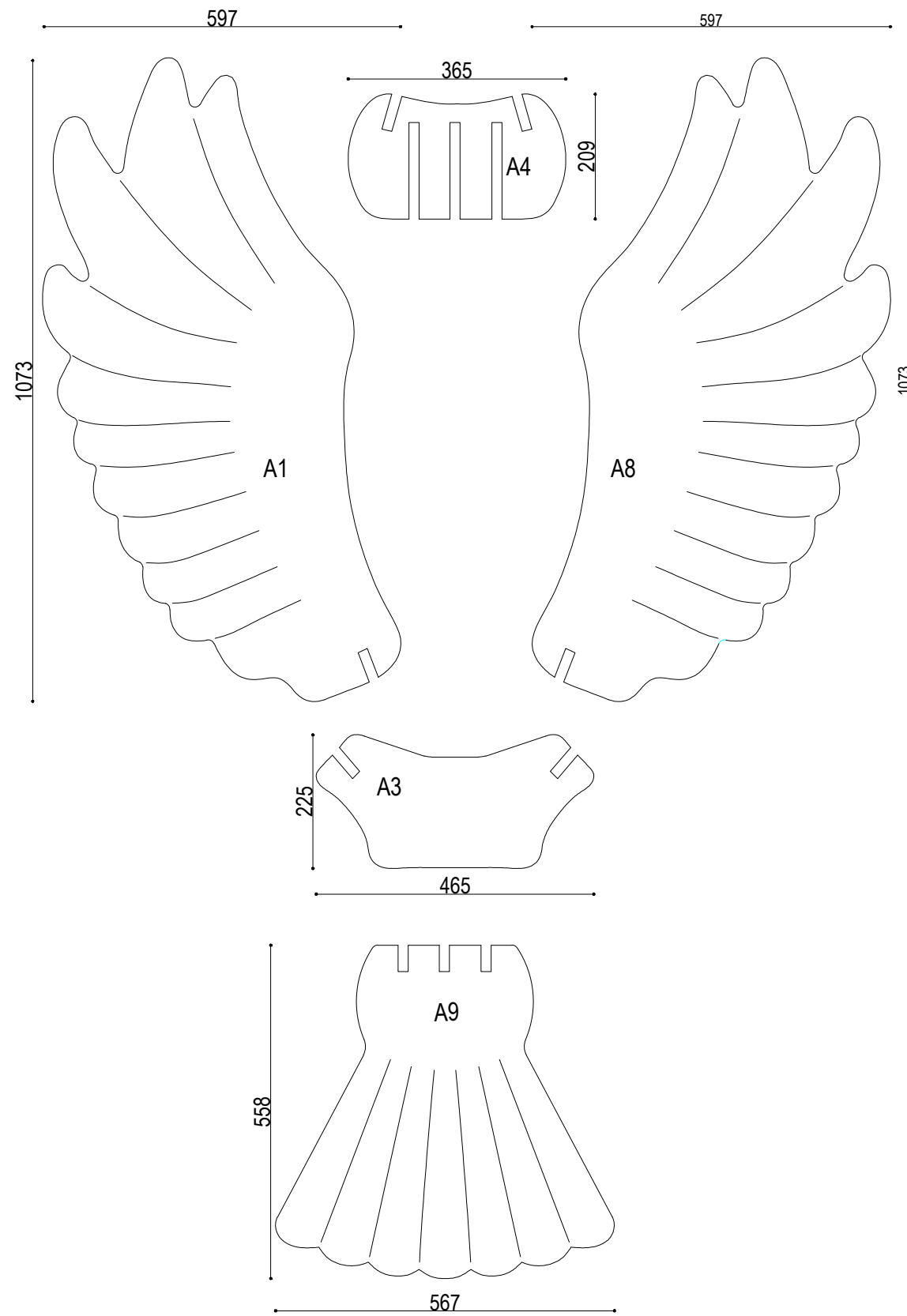

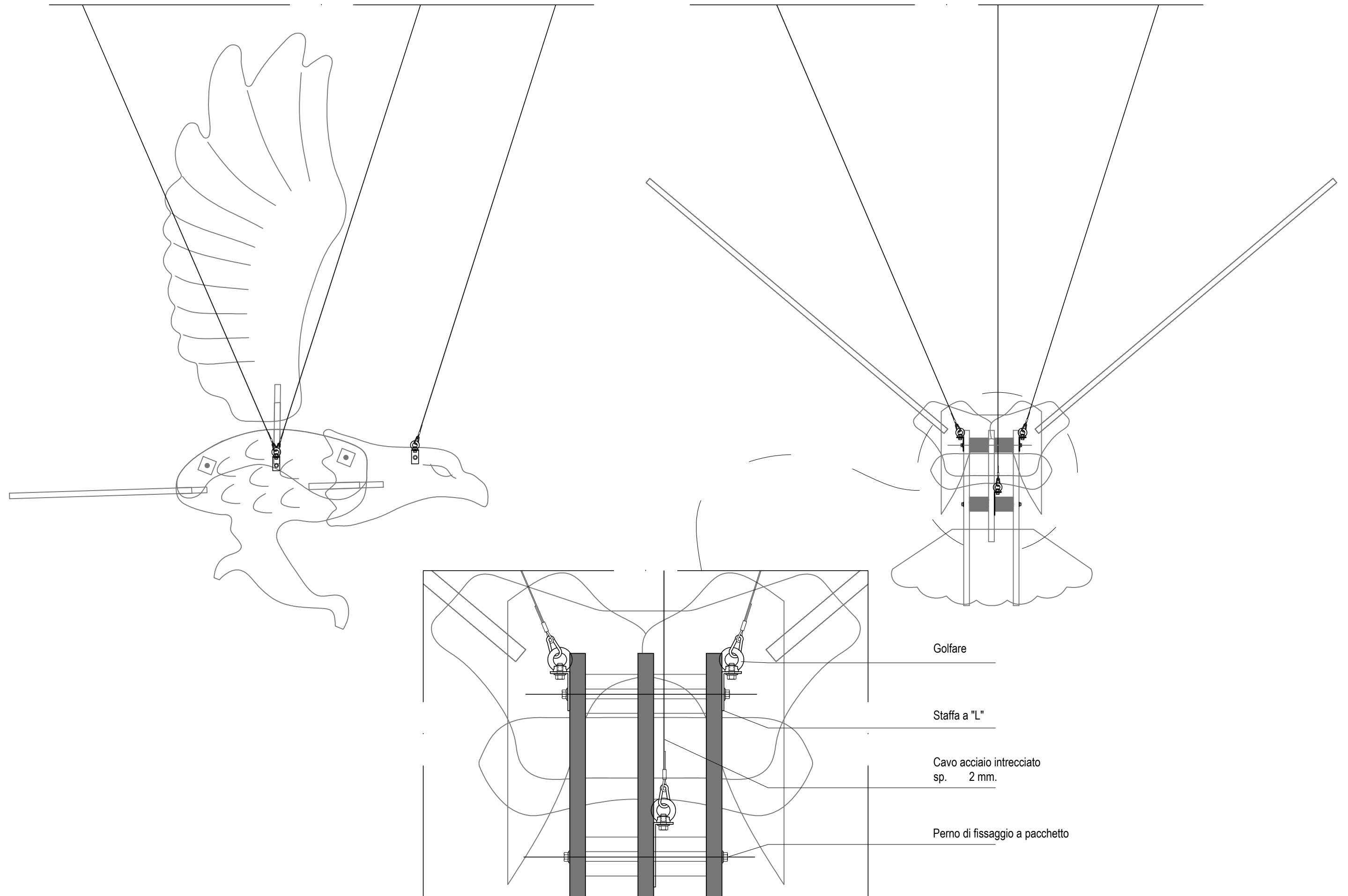

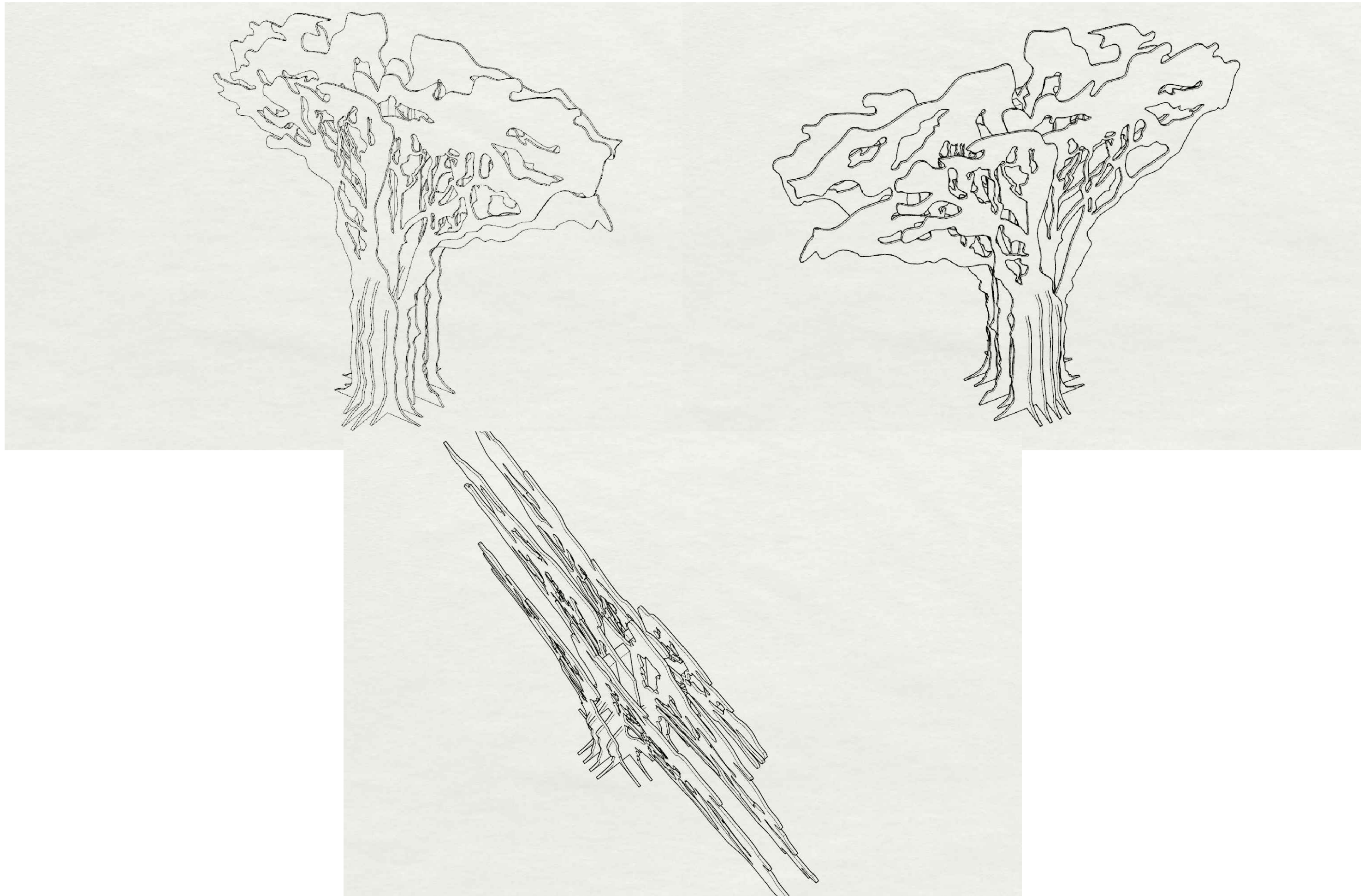

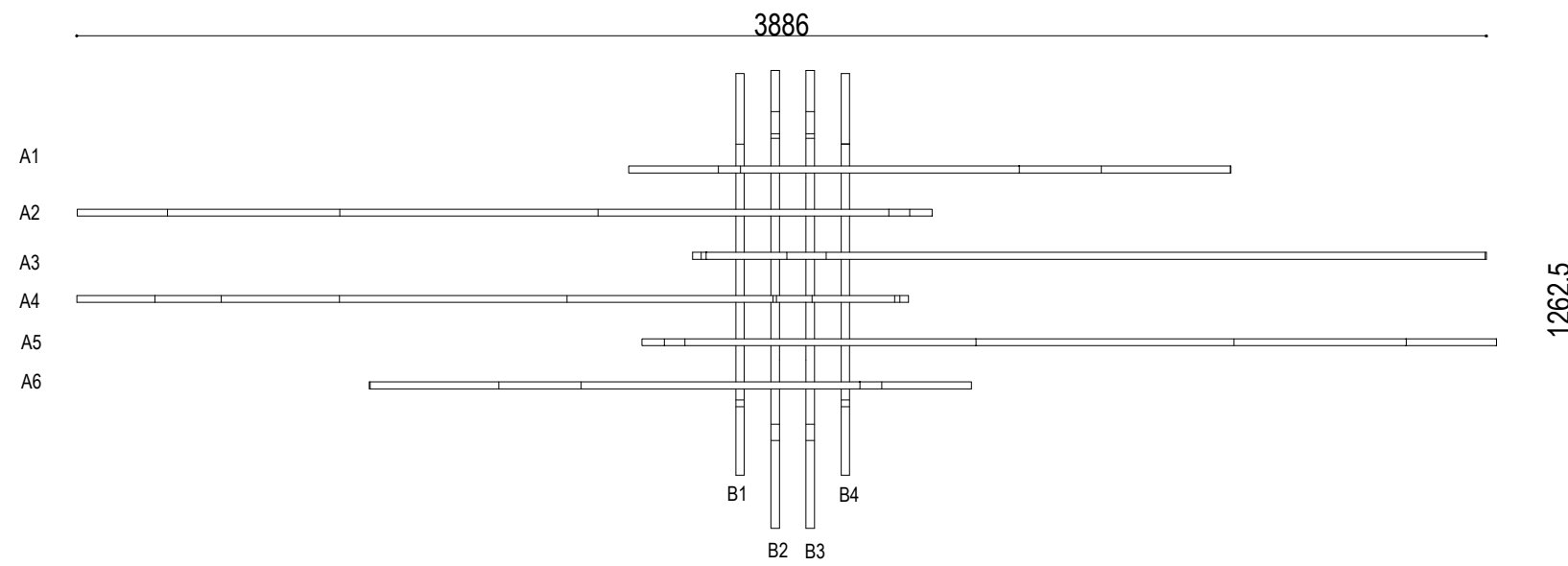

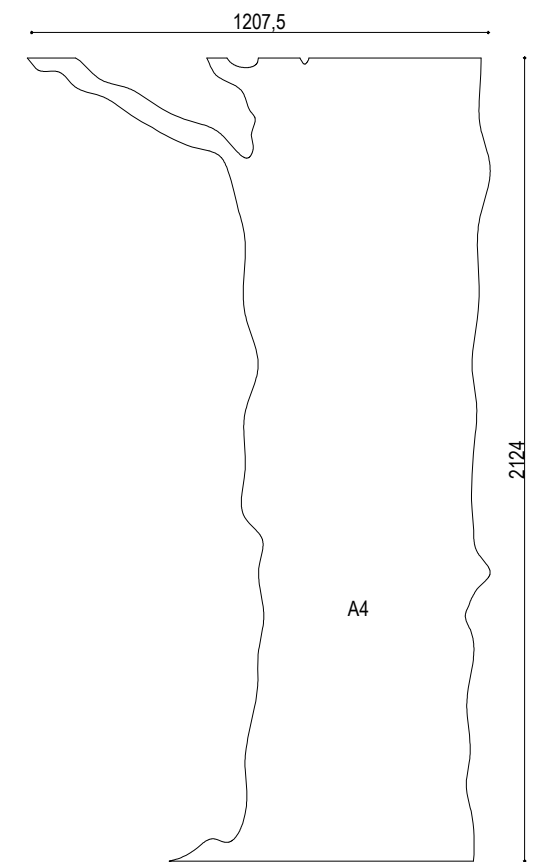
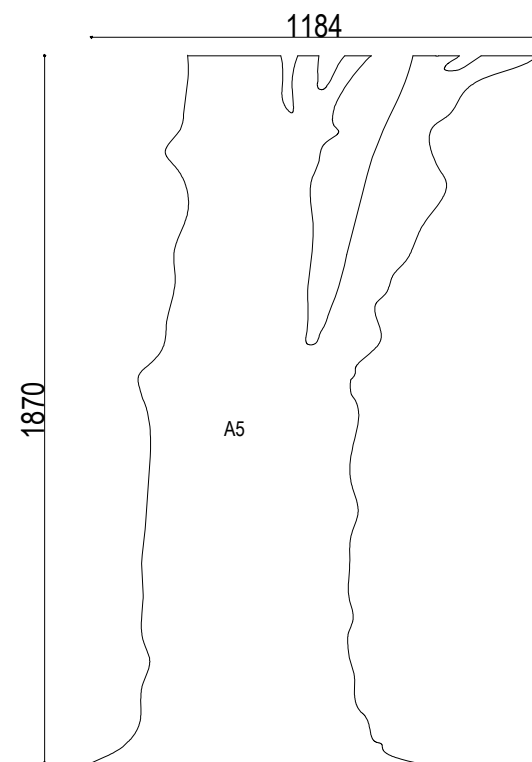
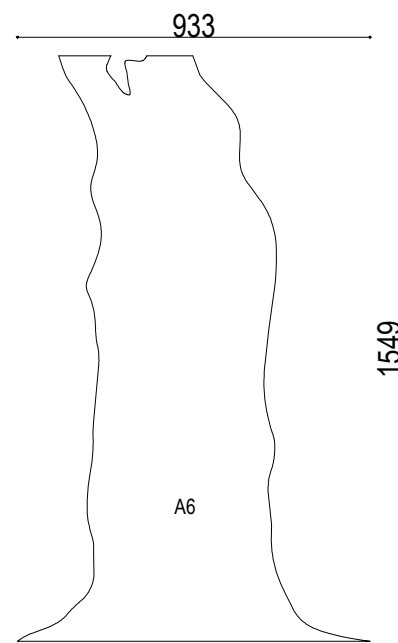
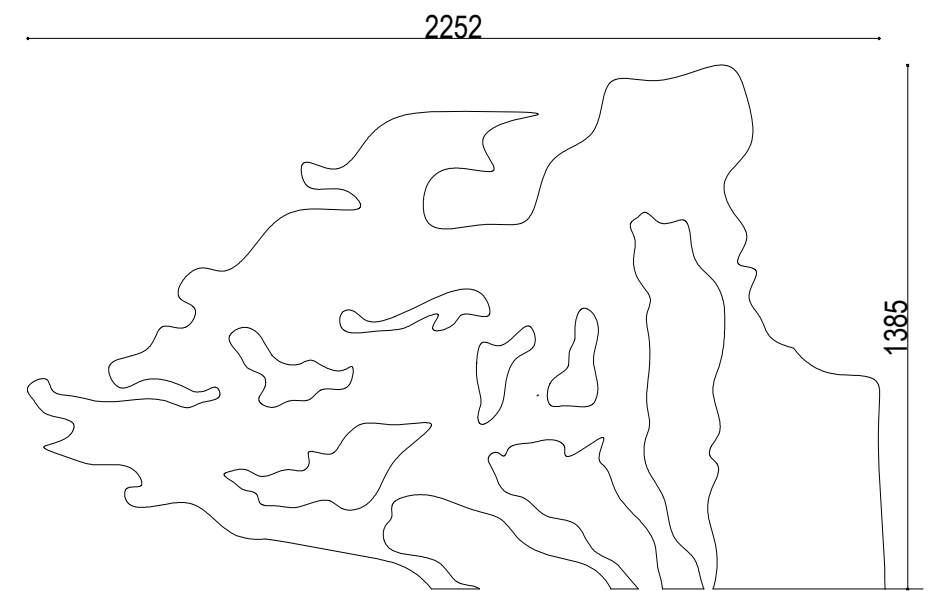
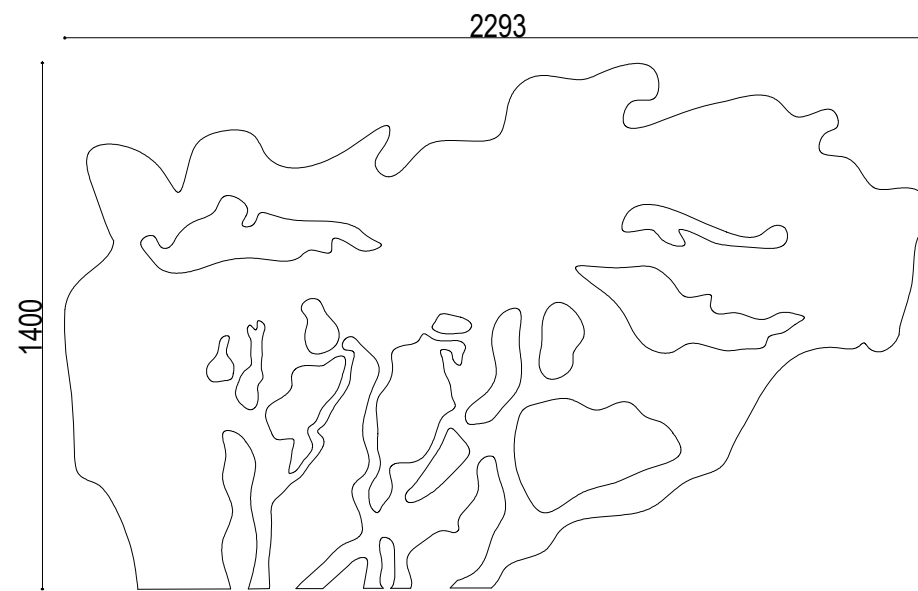
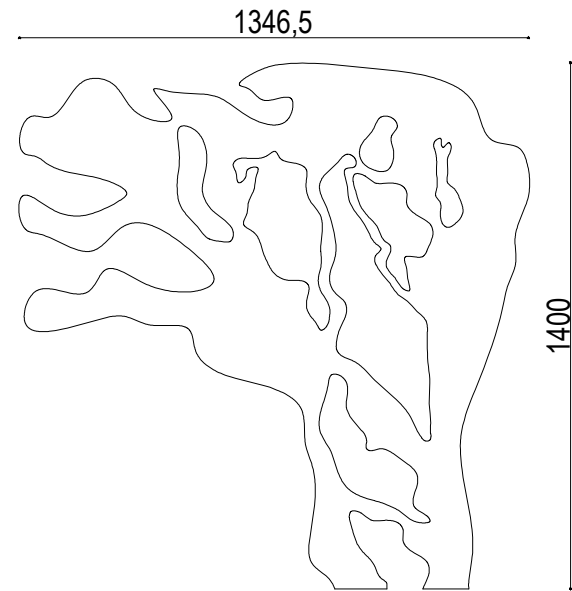

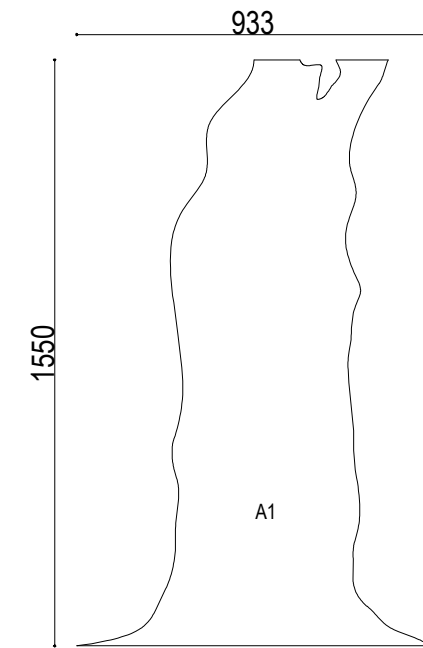
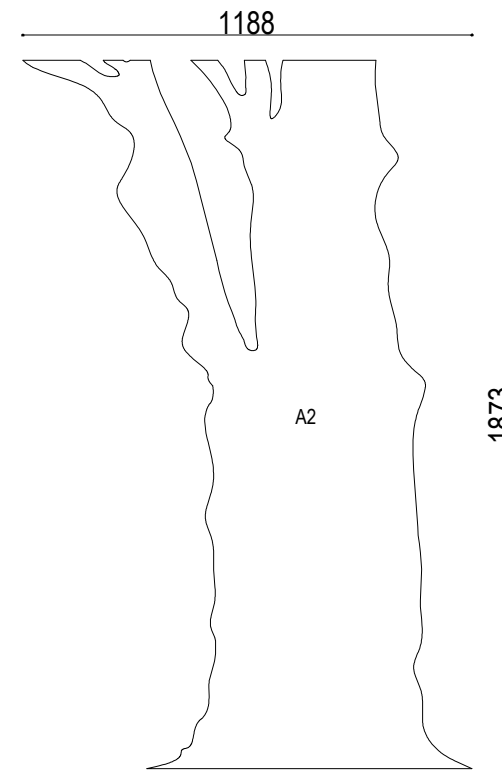
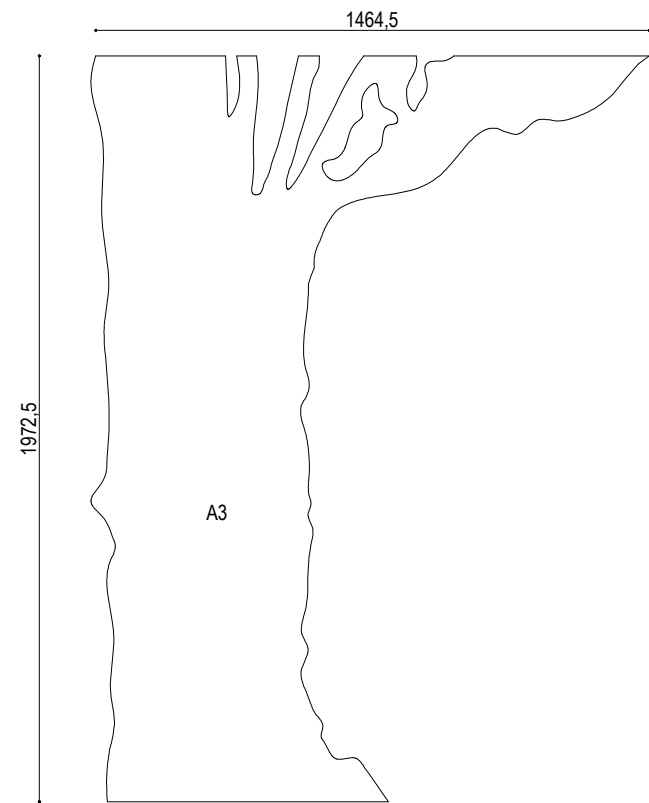
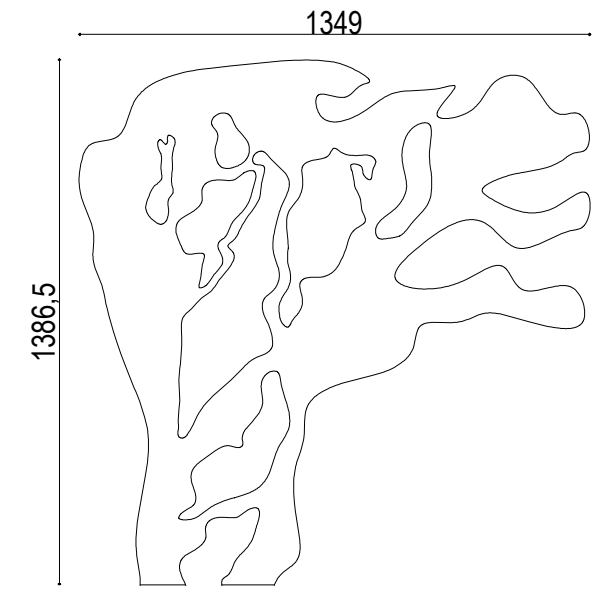
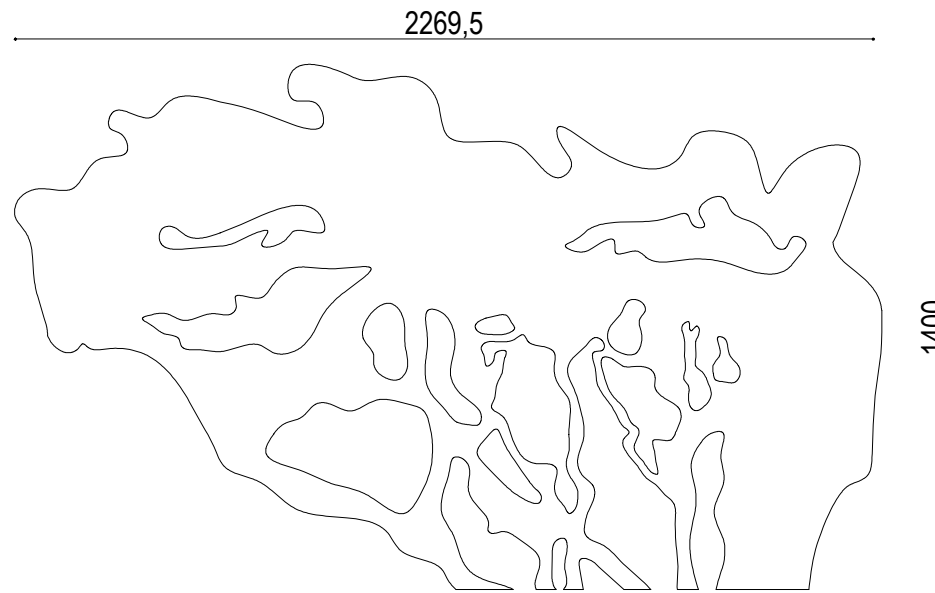
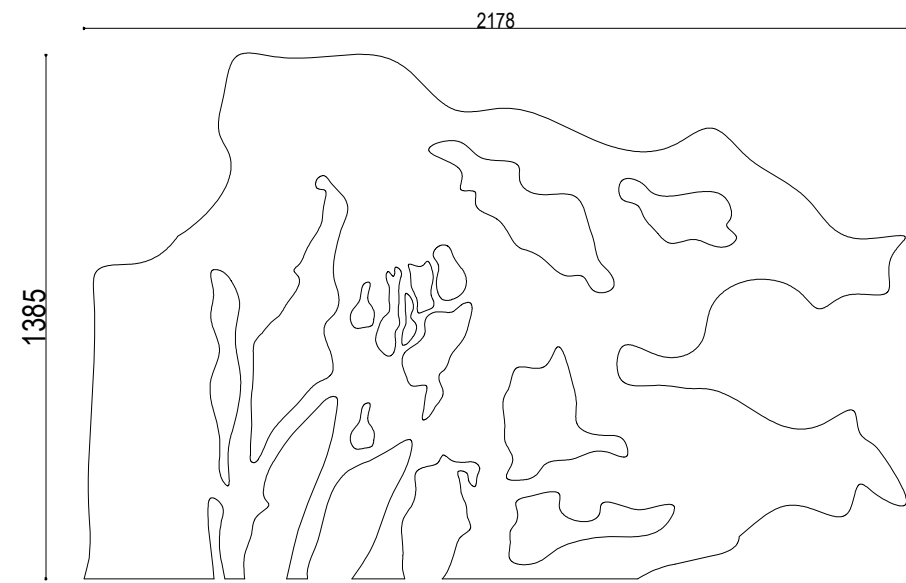

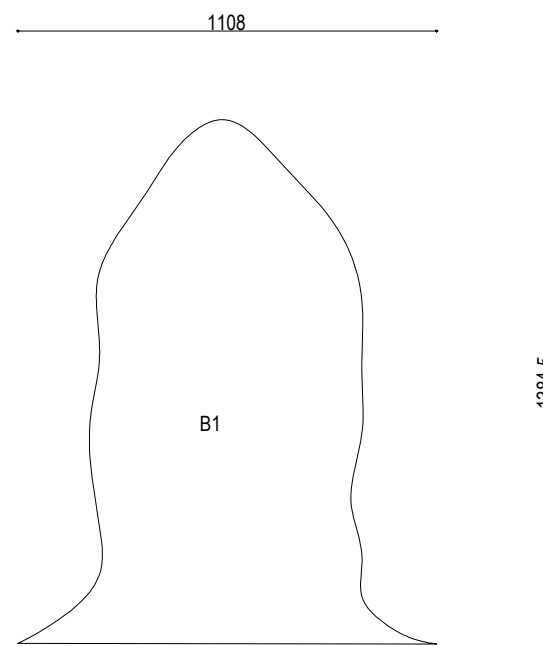
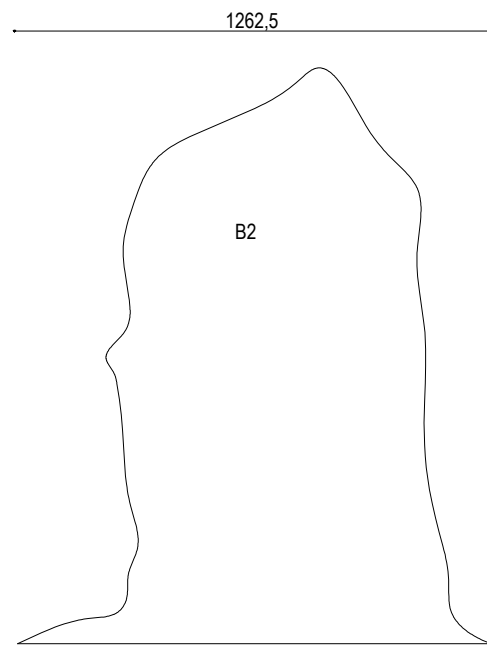
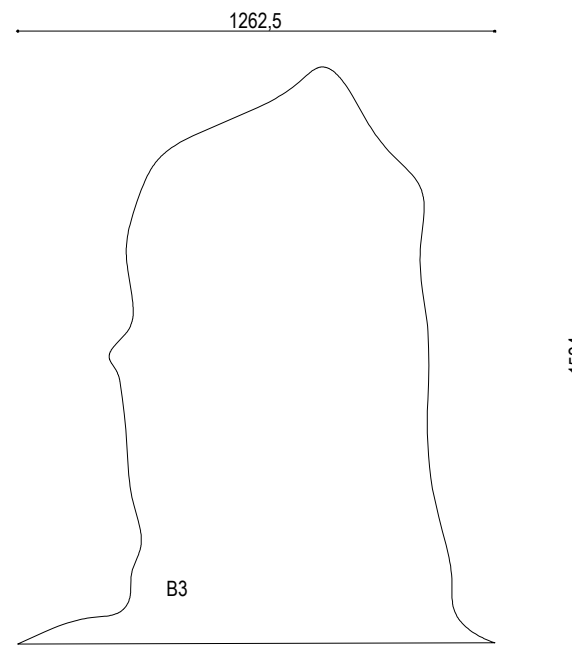
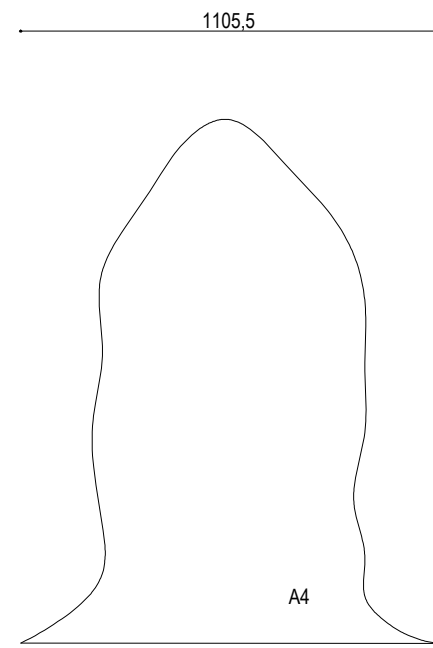

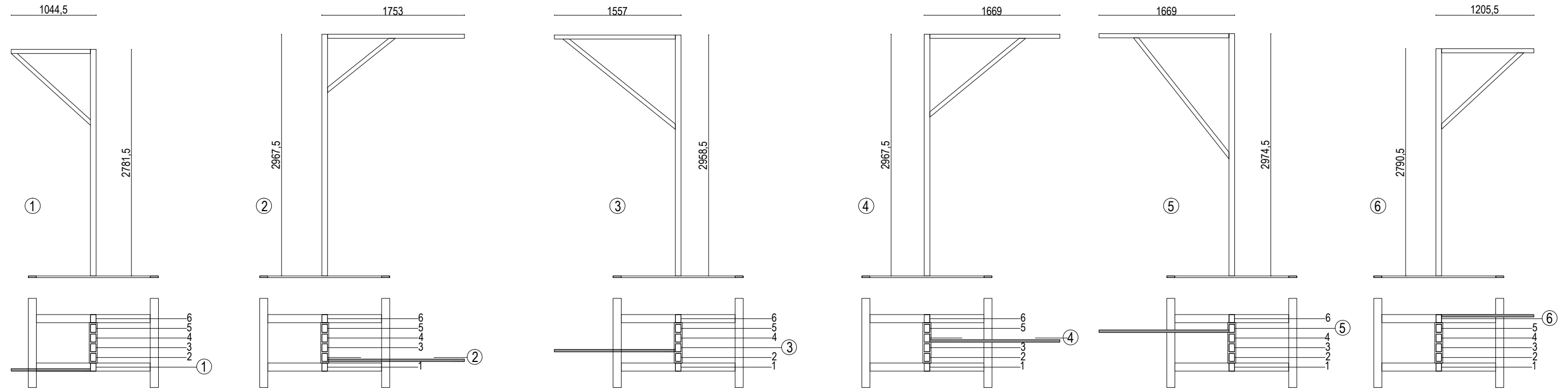

STRUTTURE IN SCATOLARE METALLICO 30X50mm. PER IL SOSTEGNO DELLE SAGOME IN MDF GREZZO

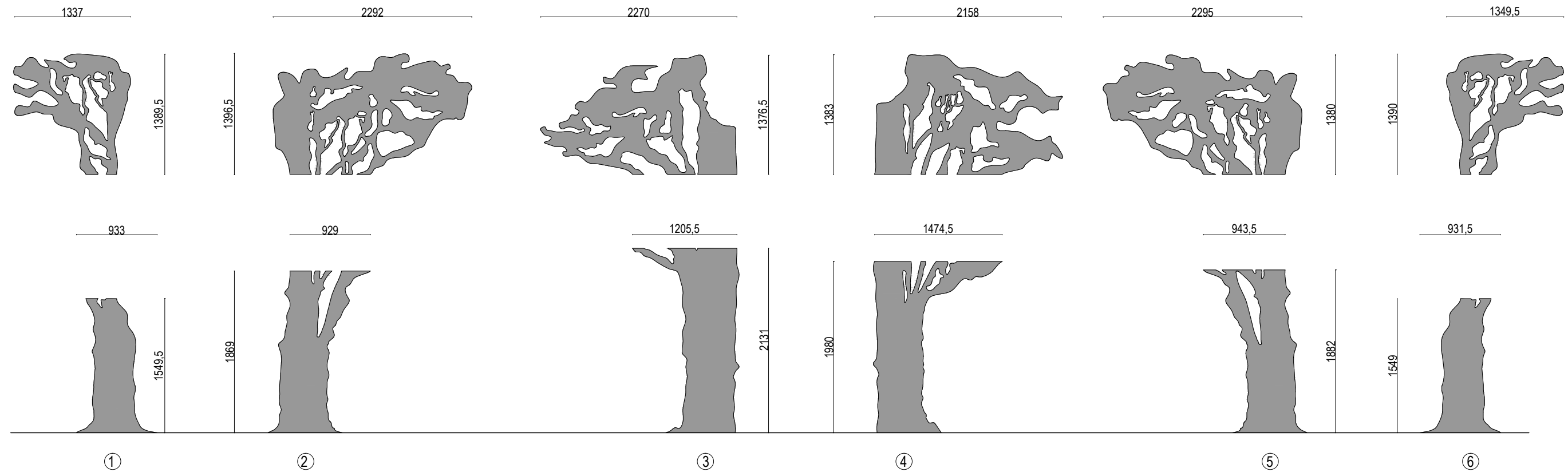

SAGOME IN MDF GREZZO DA ASSEMBLARE E FISSARE ALLE STRUTTURE IN SCATOLARE METALLICO

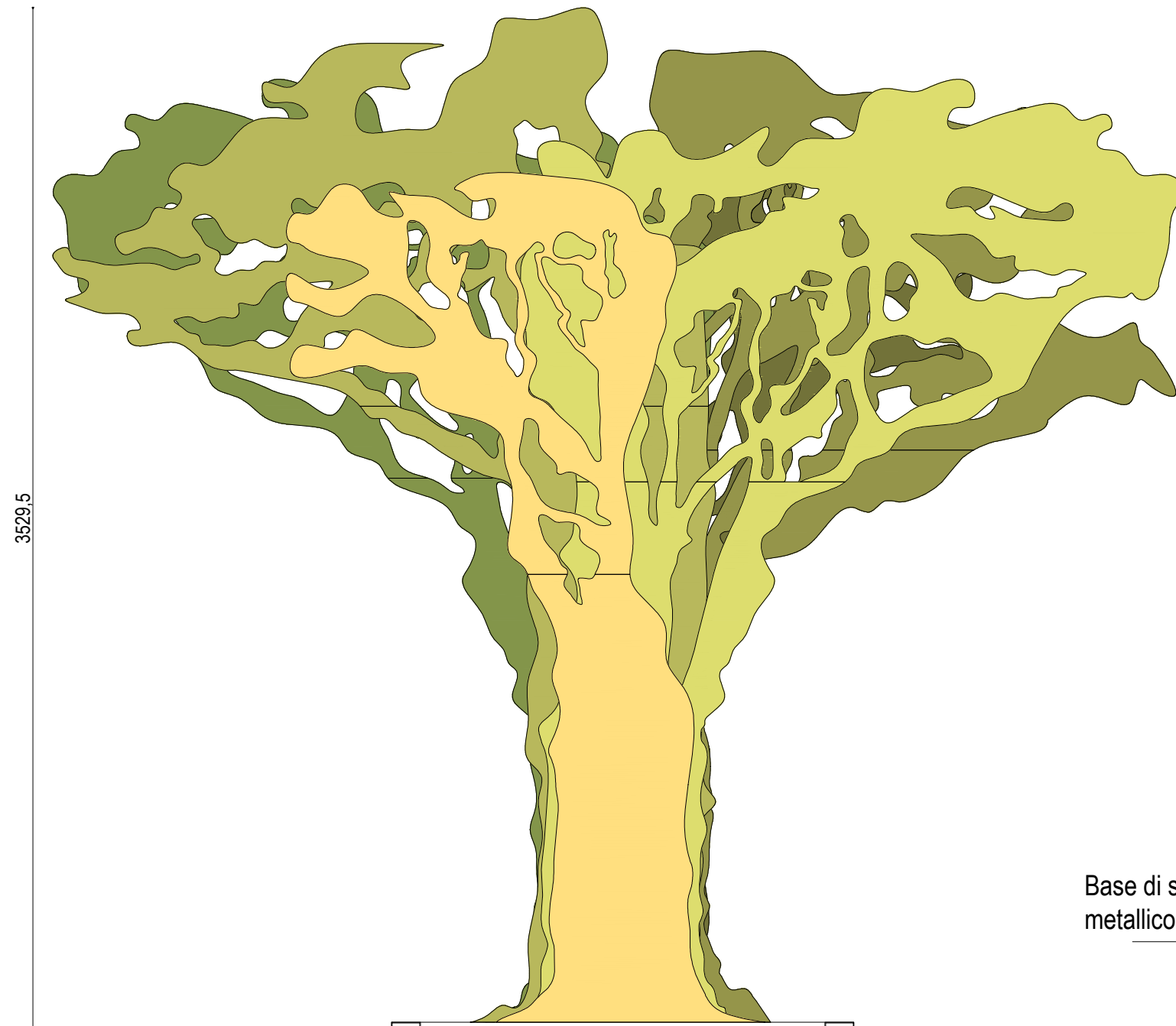

Struttura in scatolare di sostegno alle sagome in mdf

Fissaggio con viti autofilettanti

Sagome in mdf grezzo

Base di sostegno in scatolare metallico 100x20 mm.

Scatolare 70x100 mm.

Scatolare 50x30

Sagoma in mdf grezzo

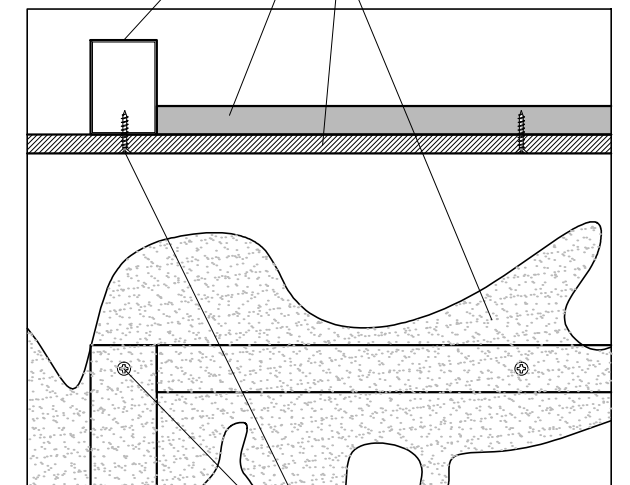

Fissaggio con viti autofilettanti

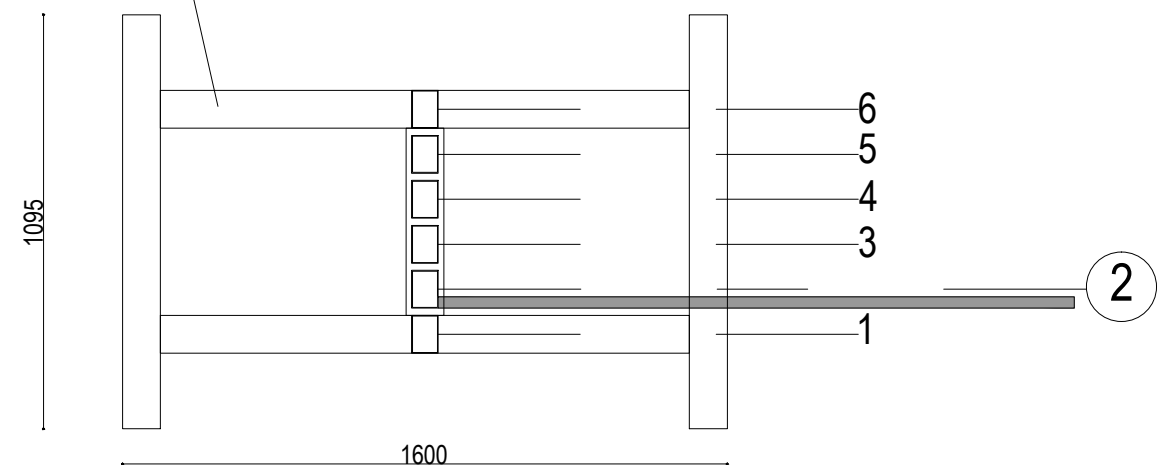
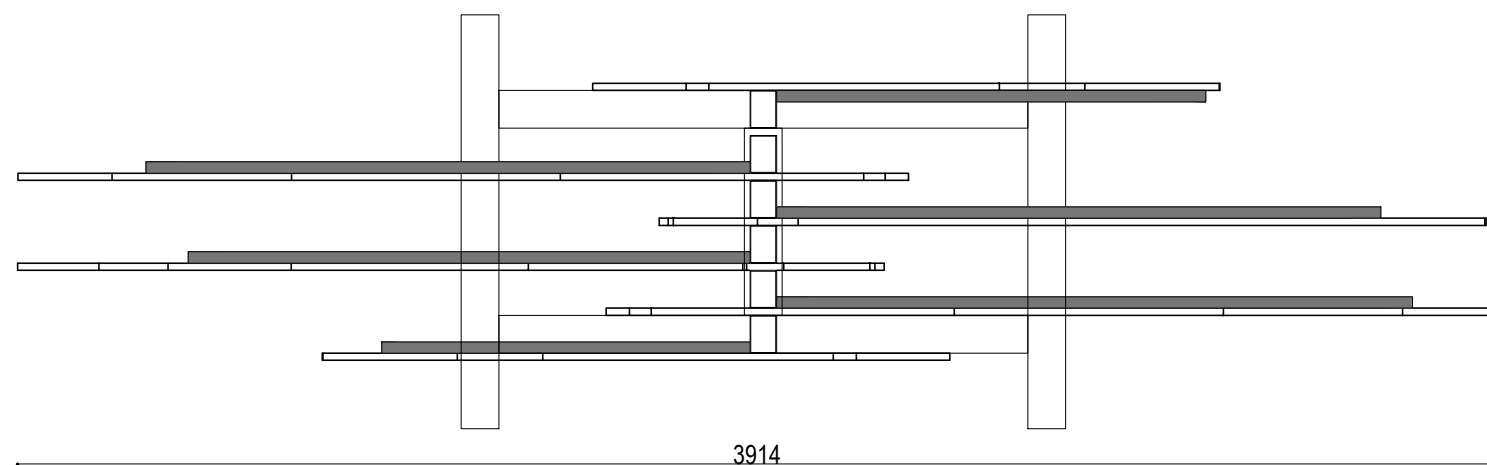

STRUTTURA BASE IN SCATOLATO METALLICO PER" ALBERO DI ACACIA"

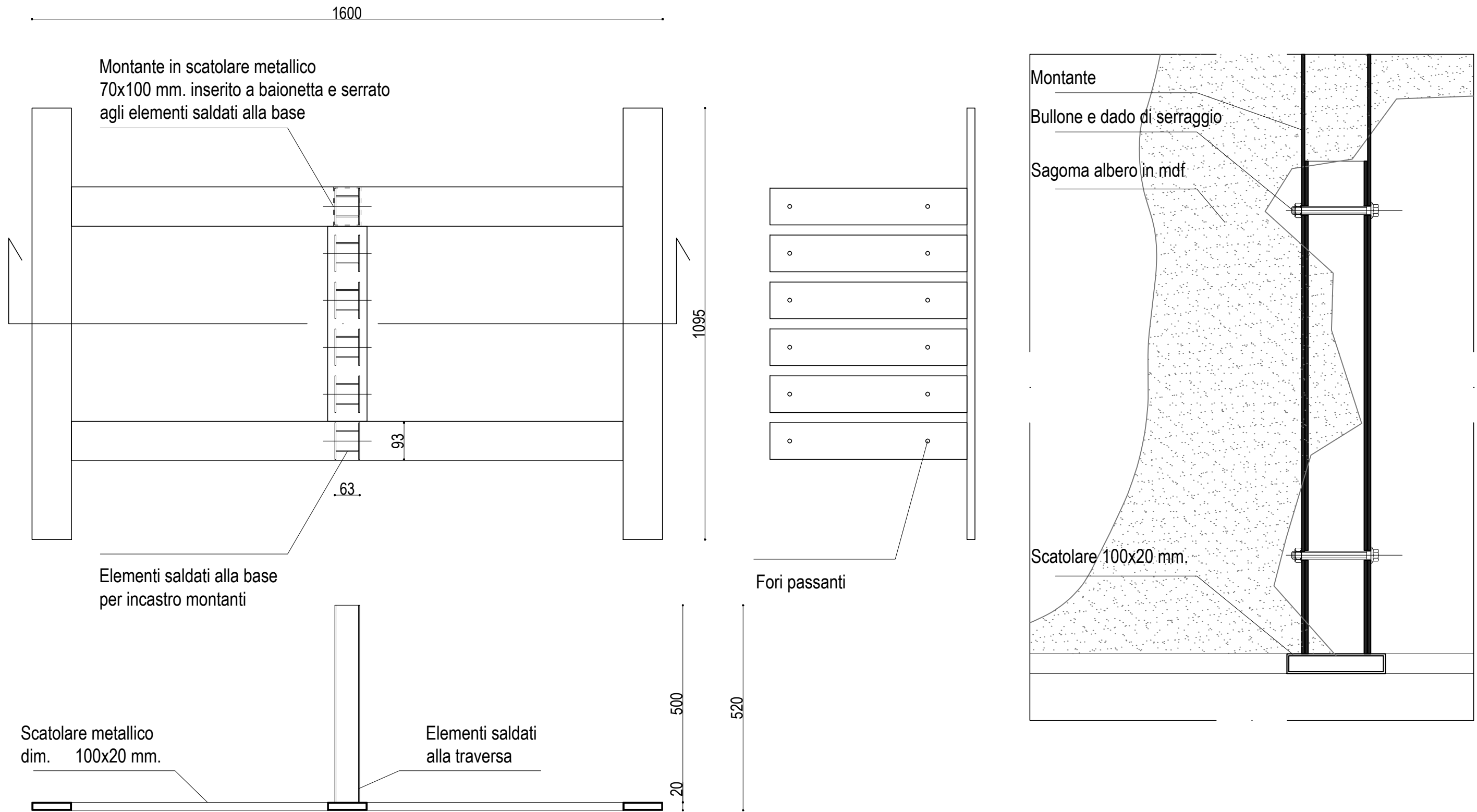

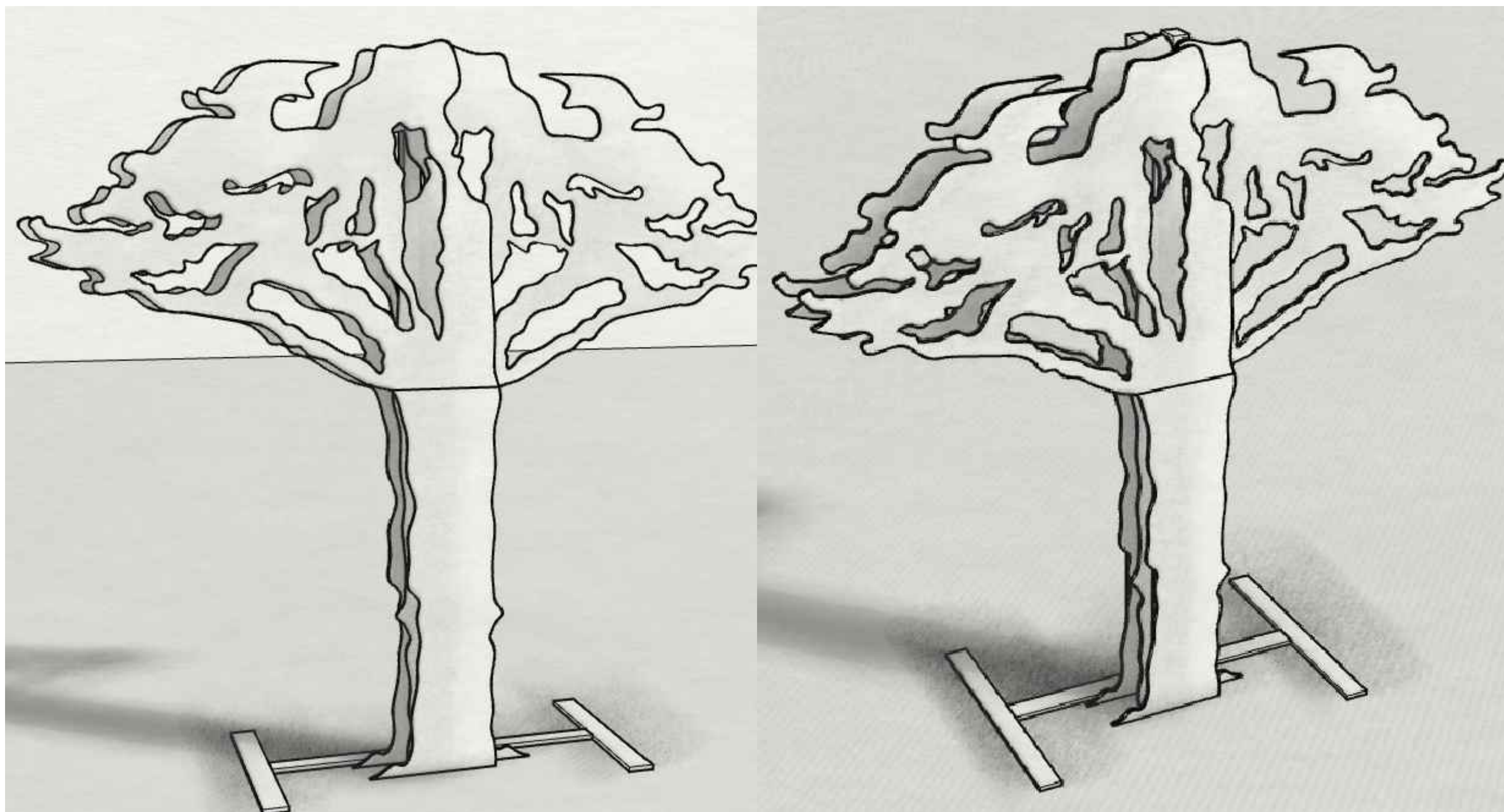

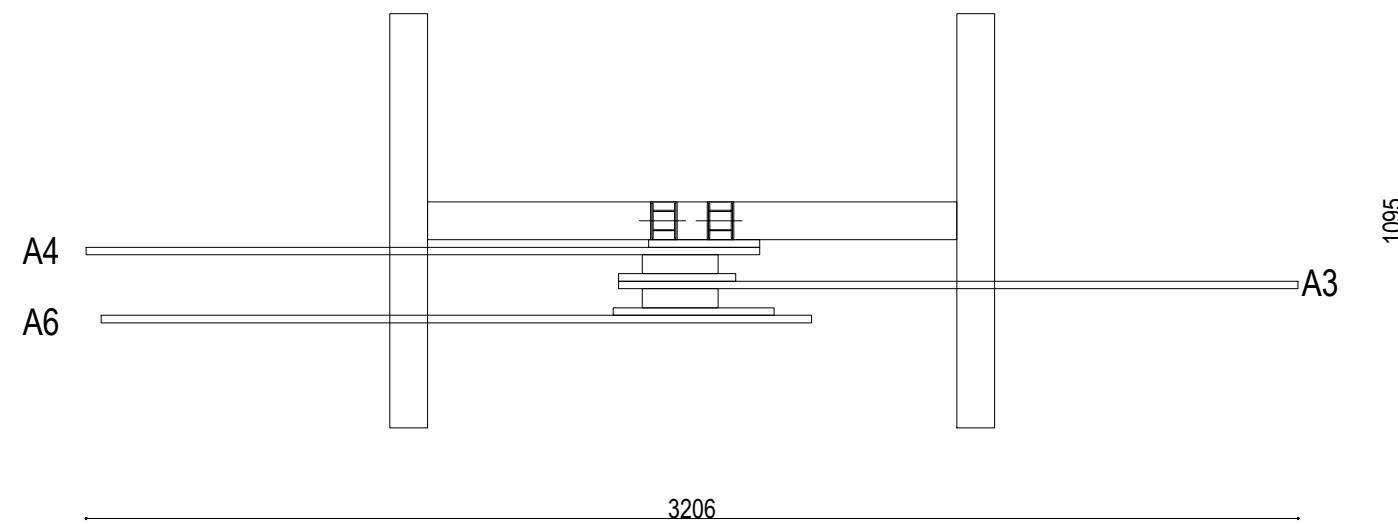
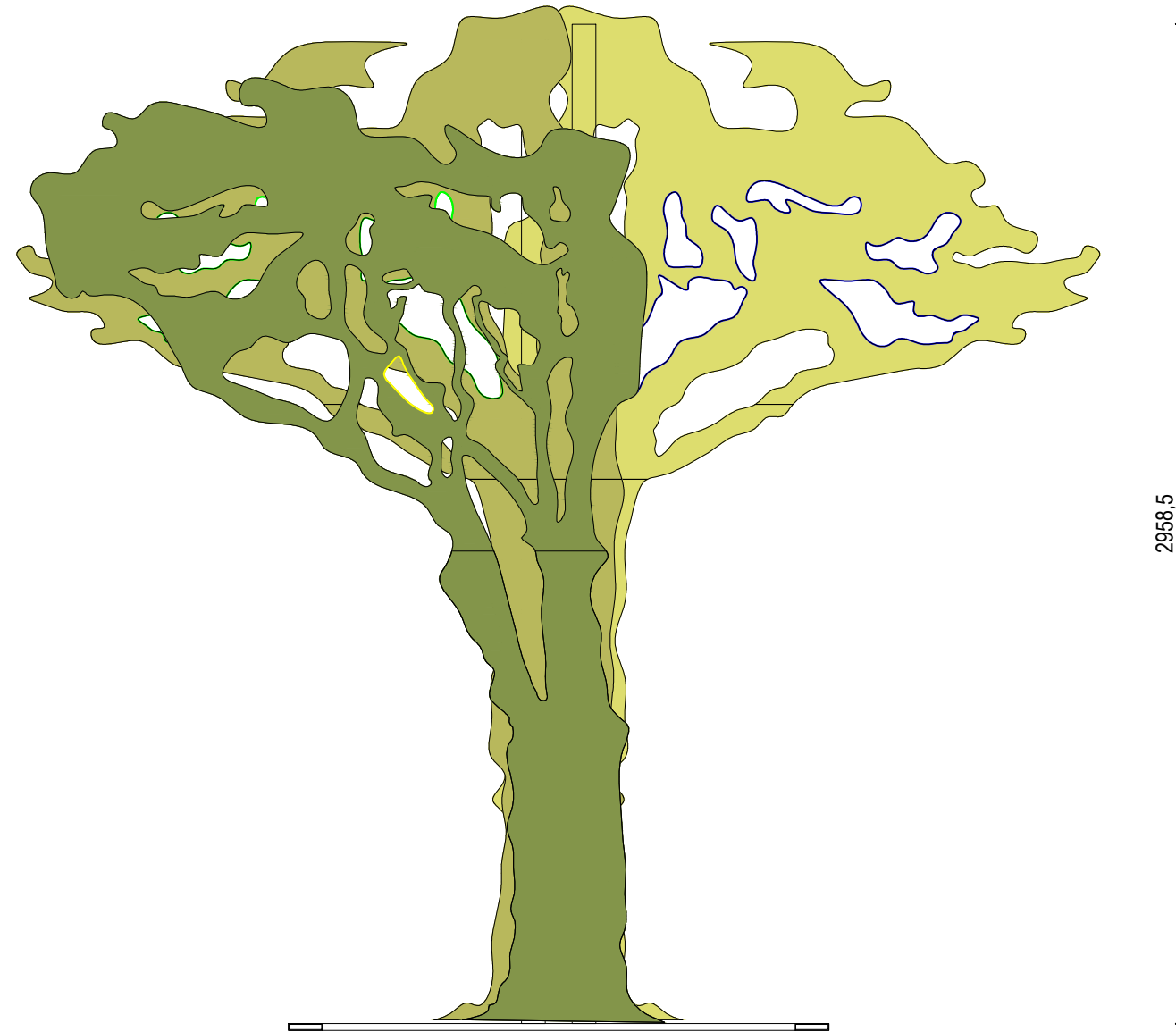

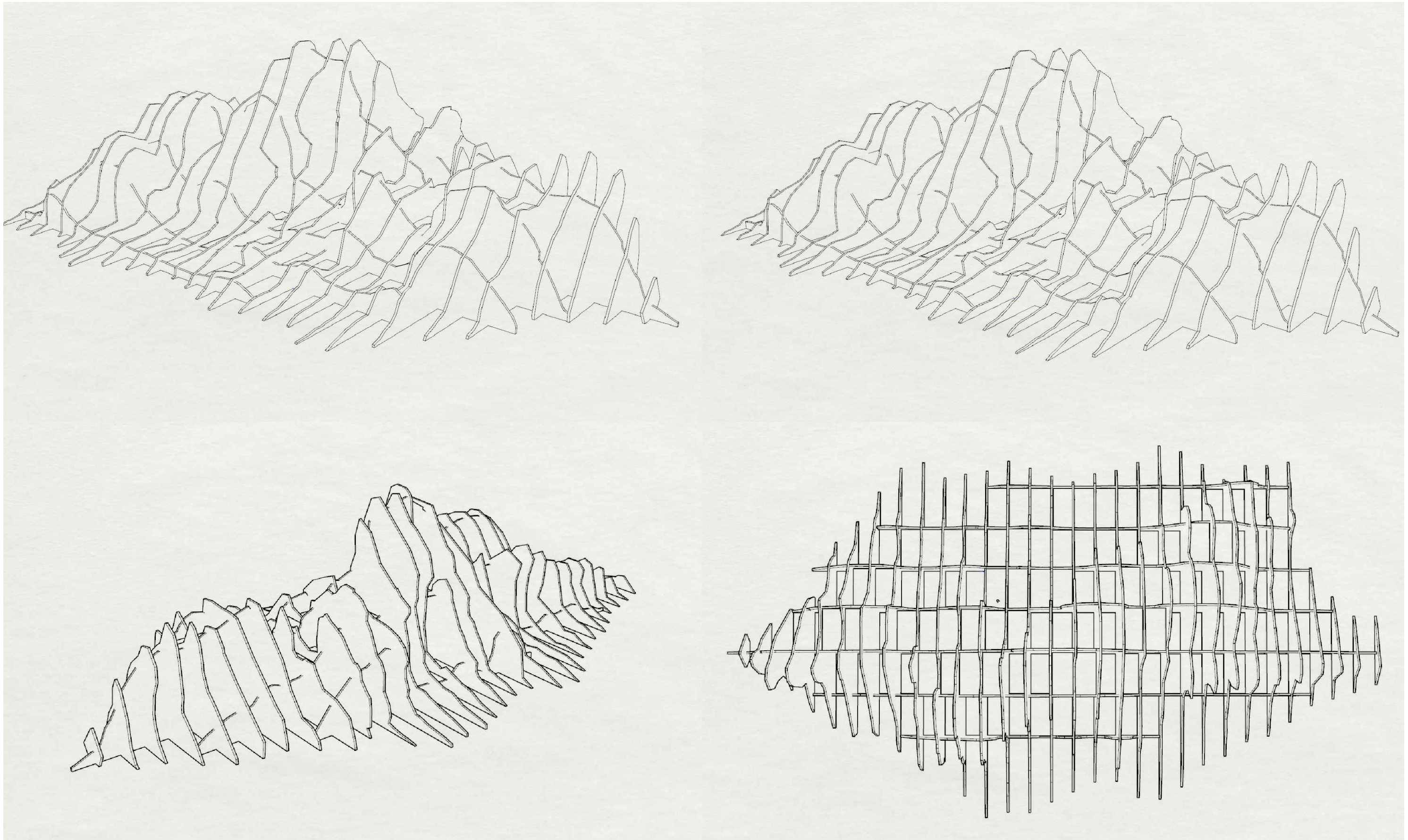

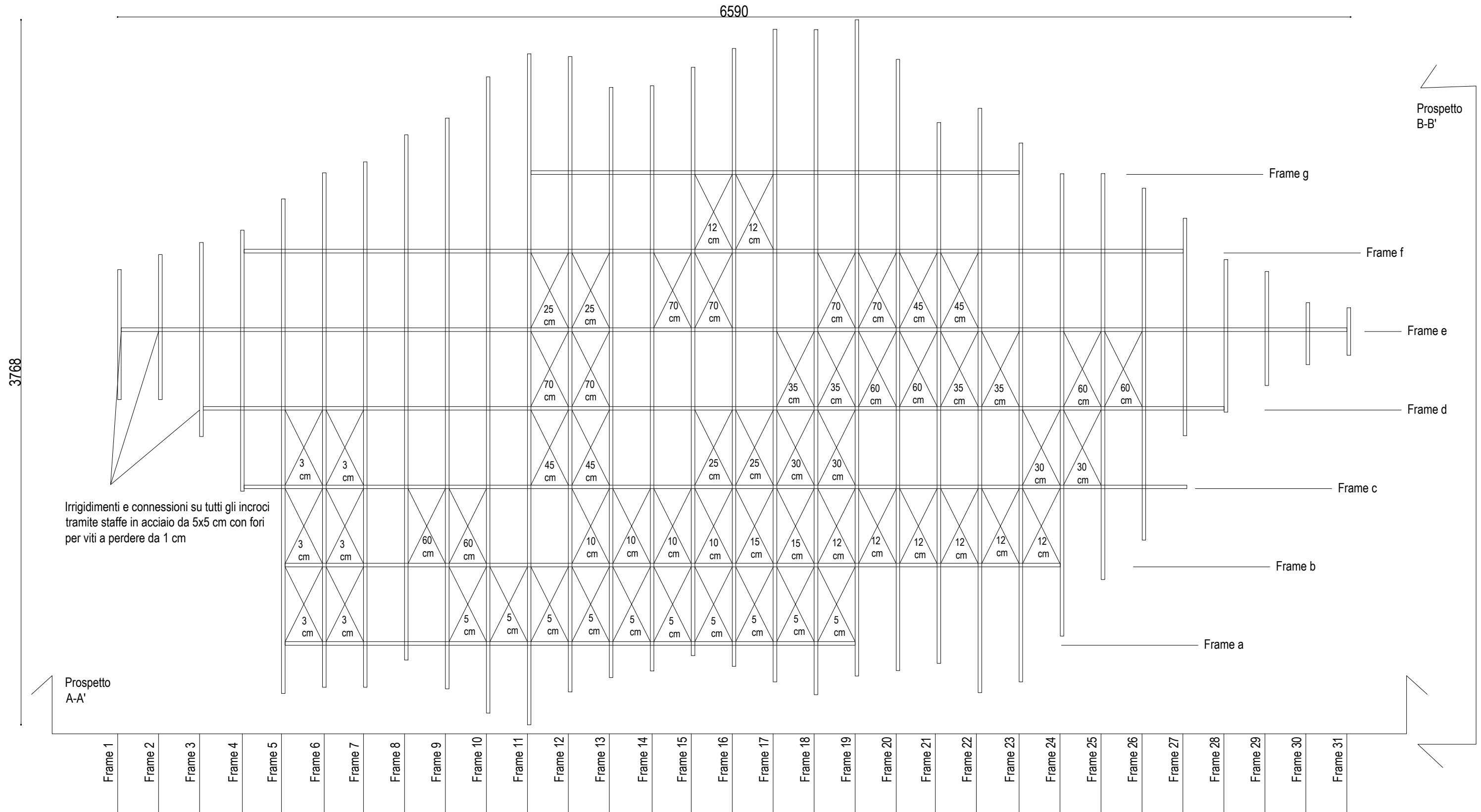

Altezza rialzi in legno, sezione orizzontale 20x40 cm, listello da 2 cm per piano orizz. e fianchi laterali (2 fianchi)

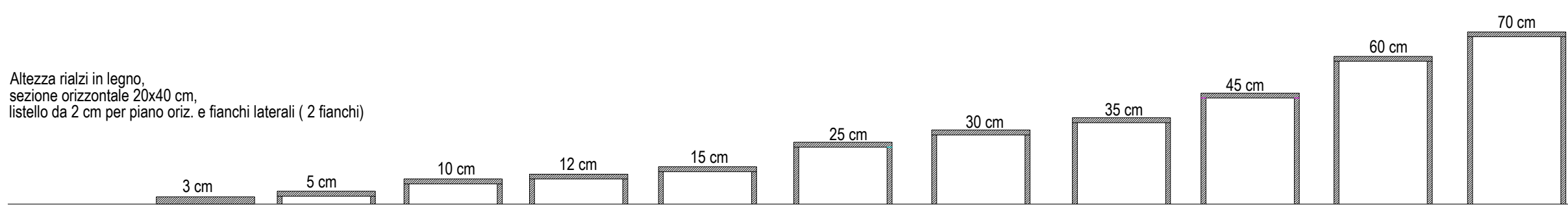

6590

1743

PROSPETTO A-A'

3768

1743

PROSPETTO B-B'

FRAME A

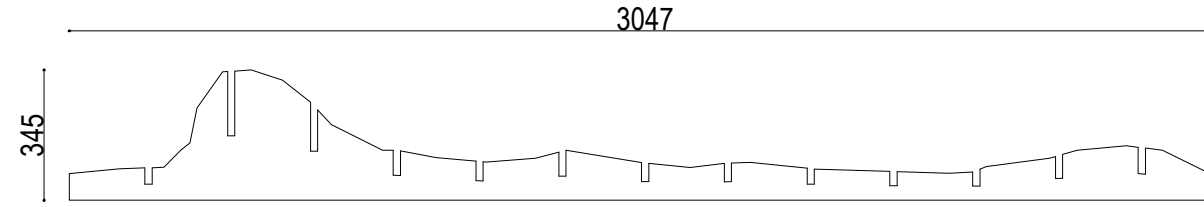

FRAME B

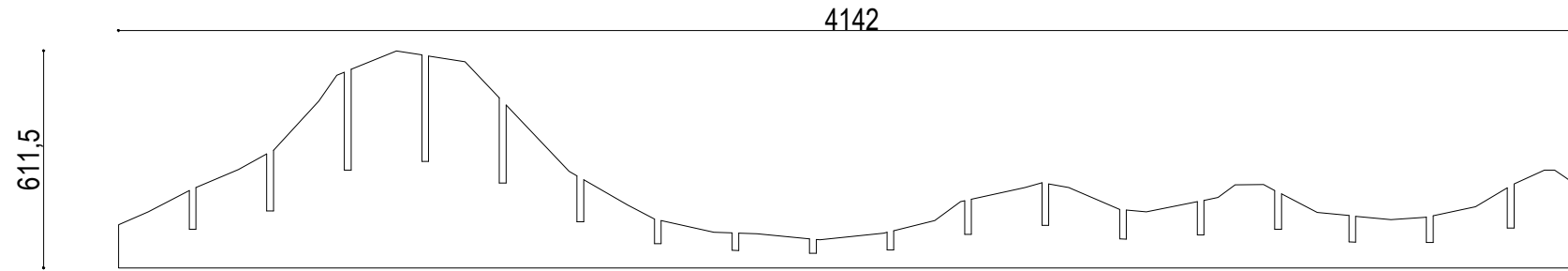

FRAME C

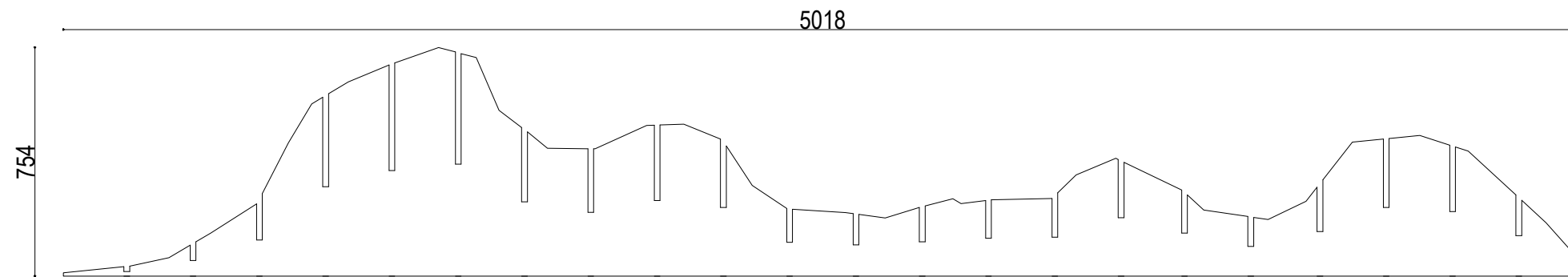

FRAME D

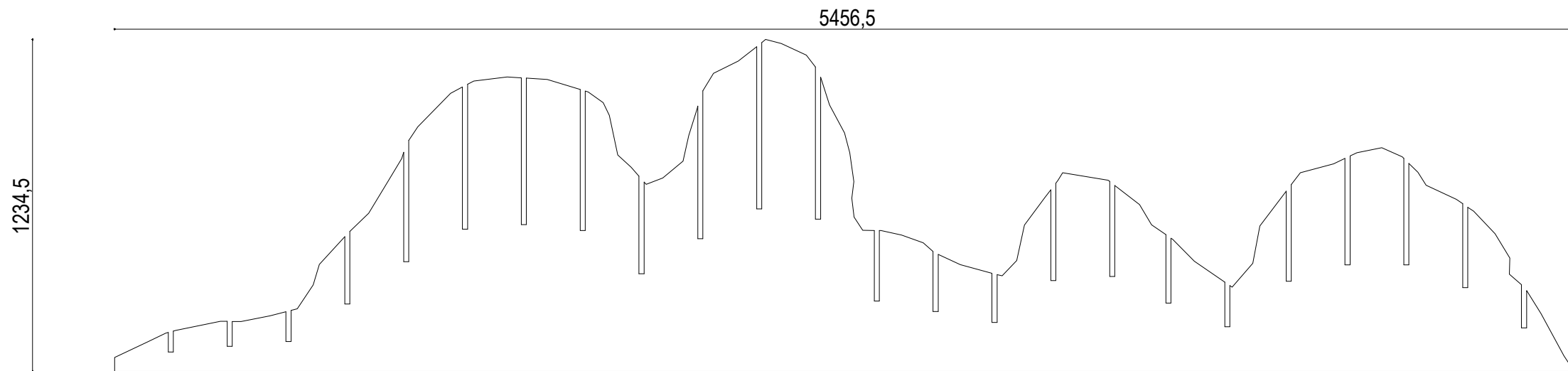

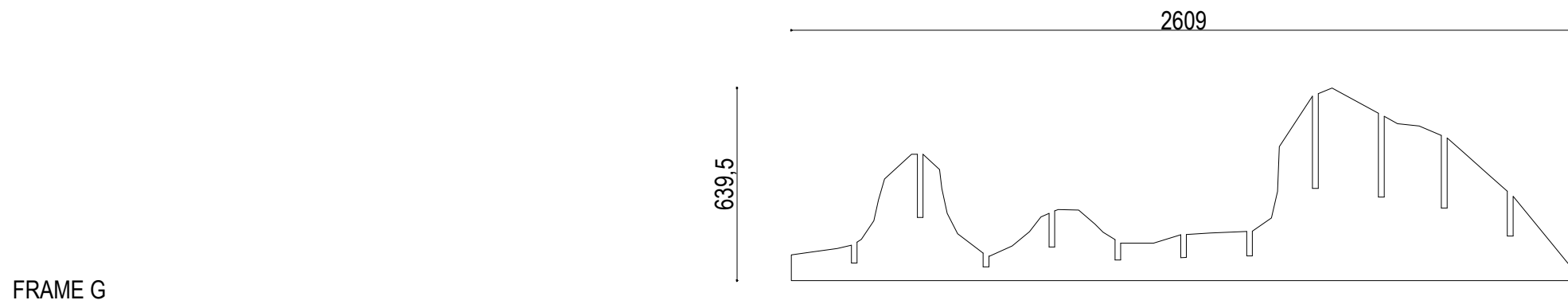
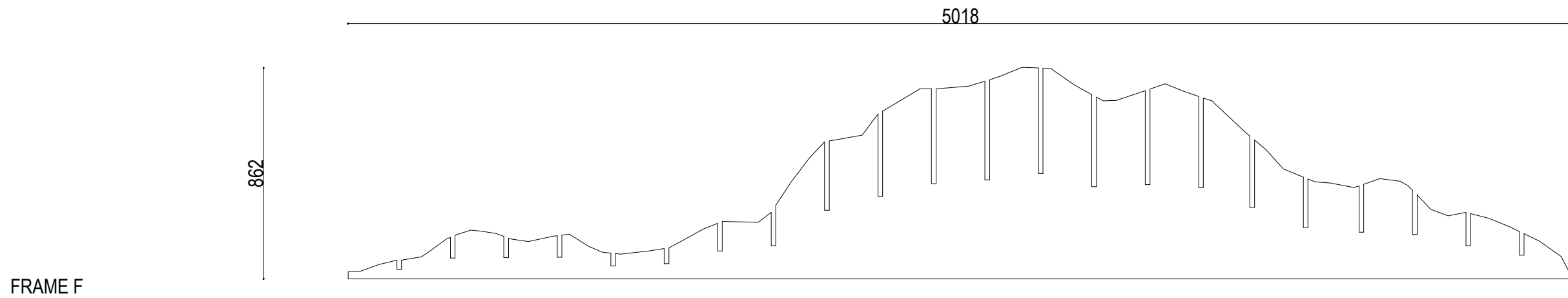
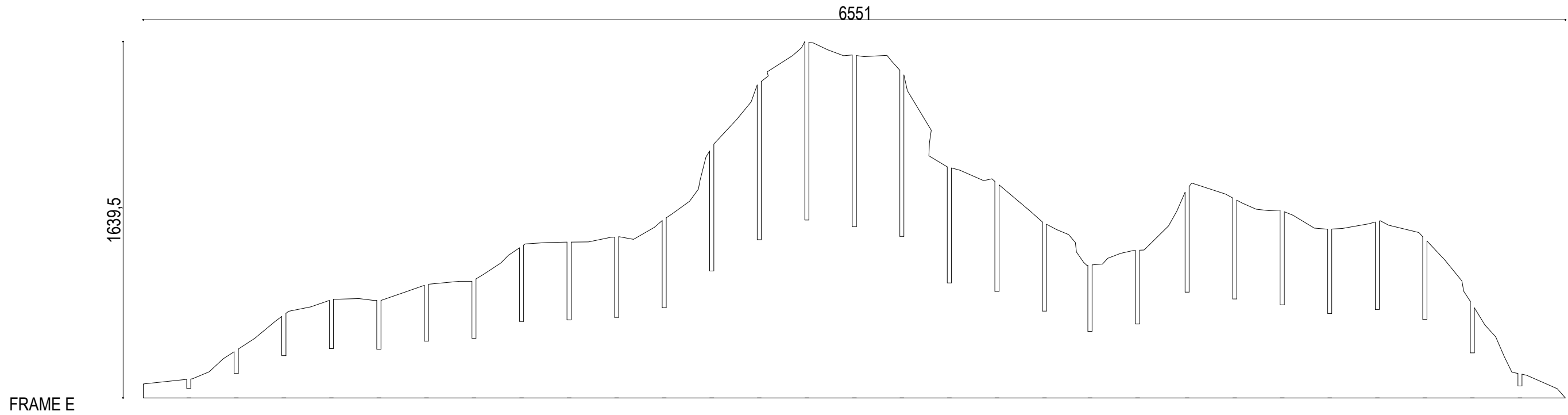

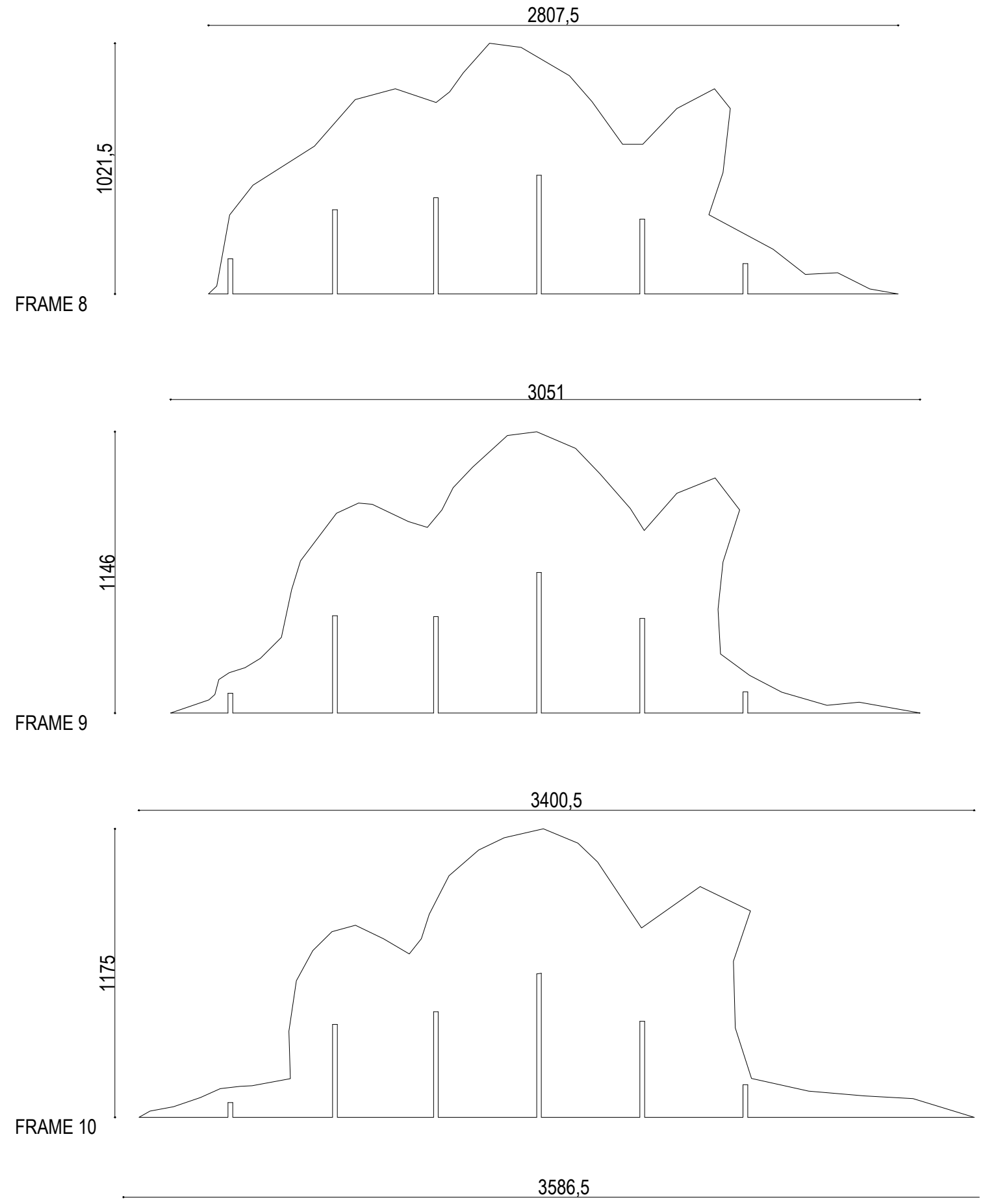
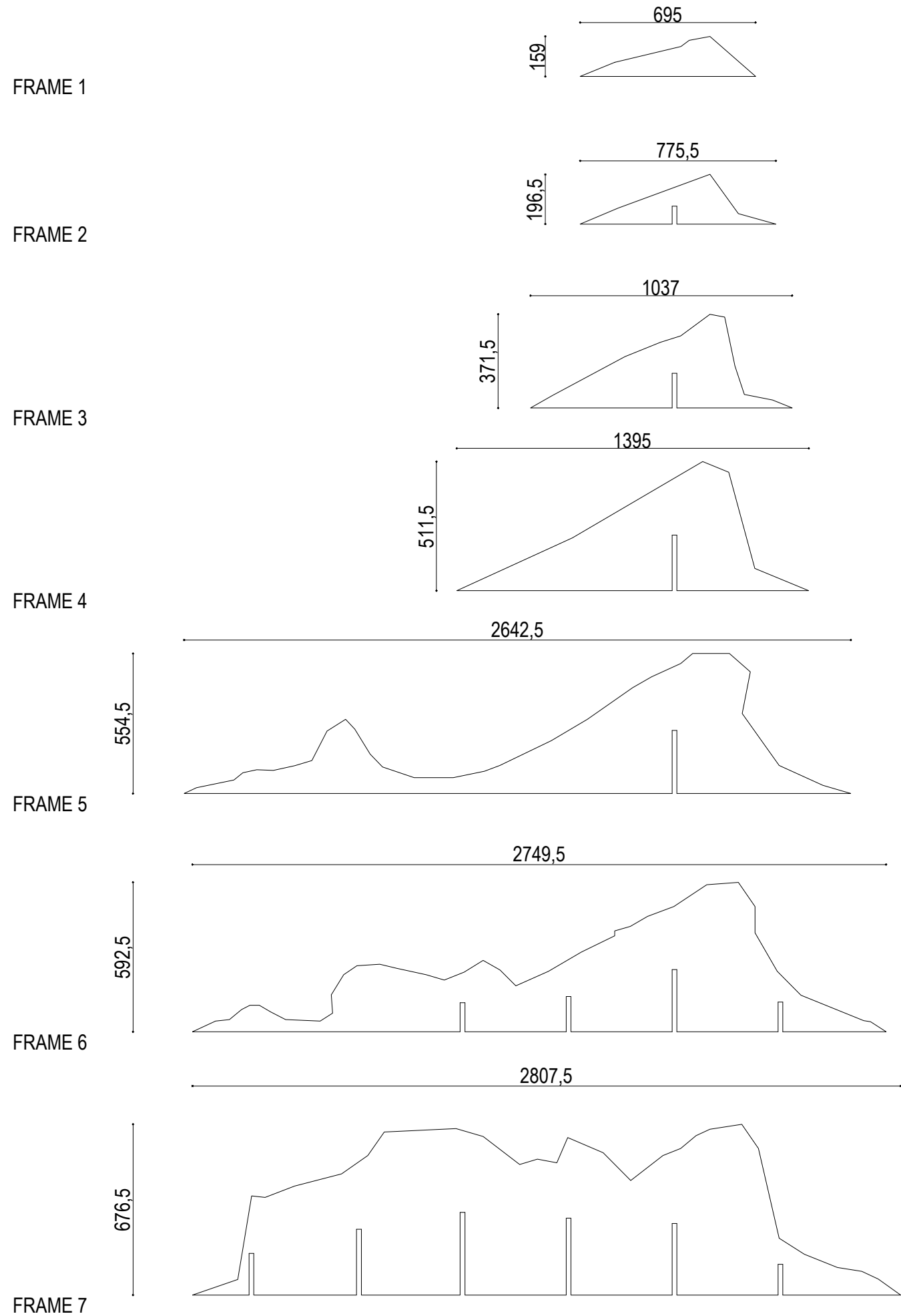

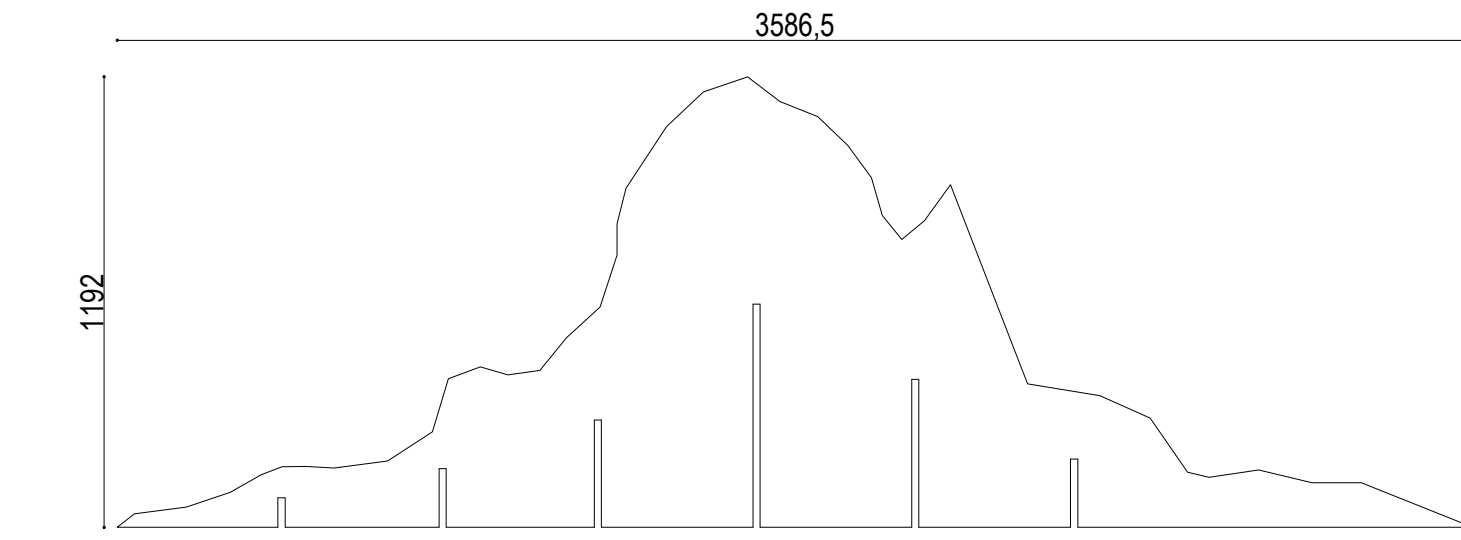

FRAME 11

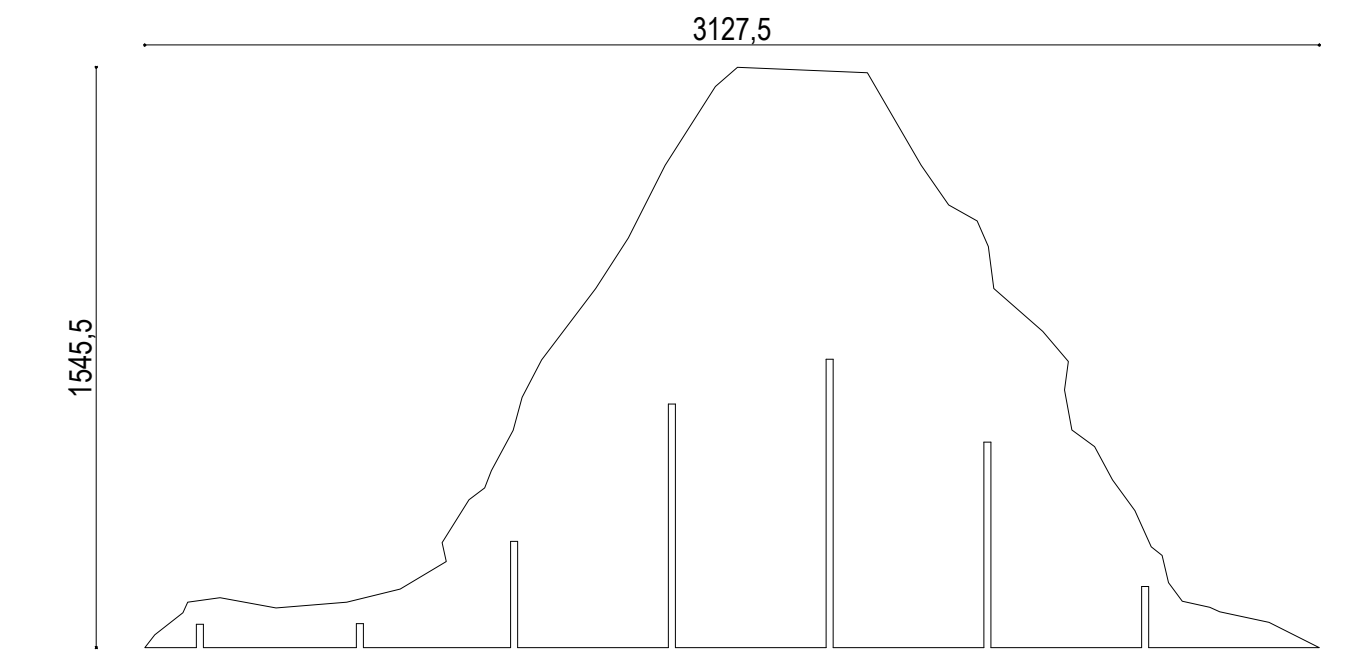

FRAME 14

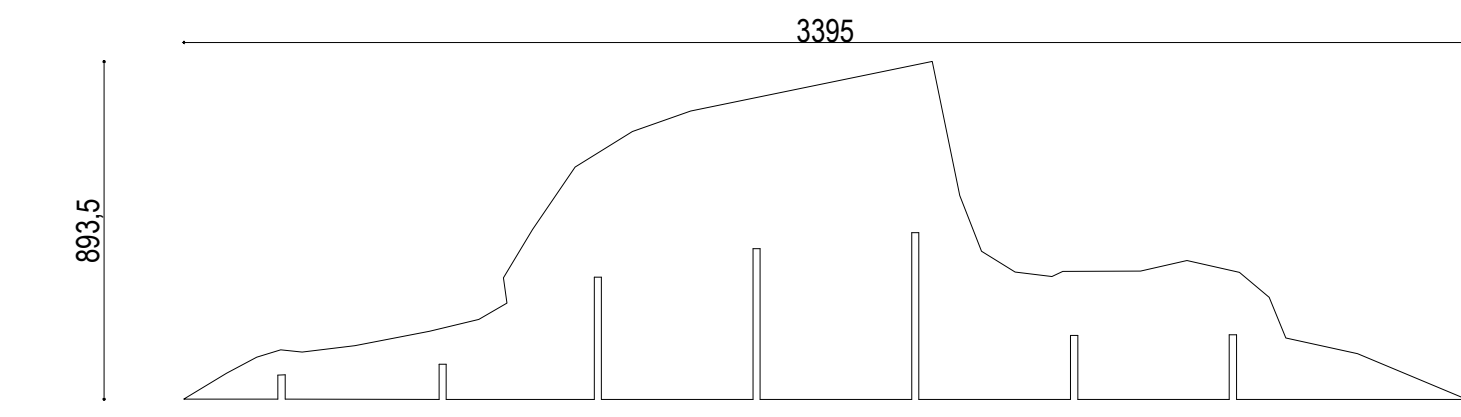

FRAME 12

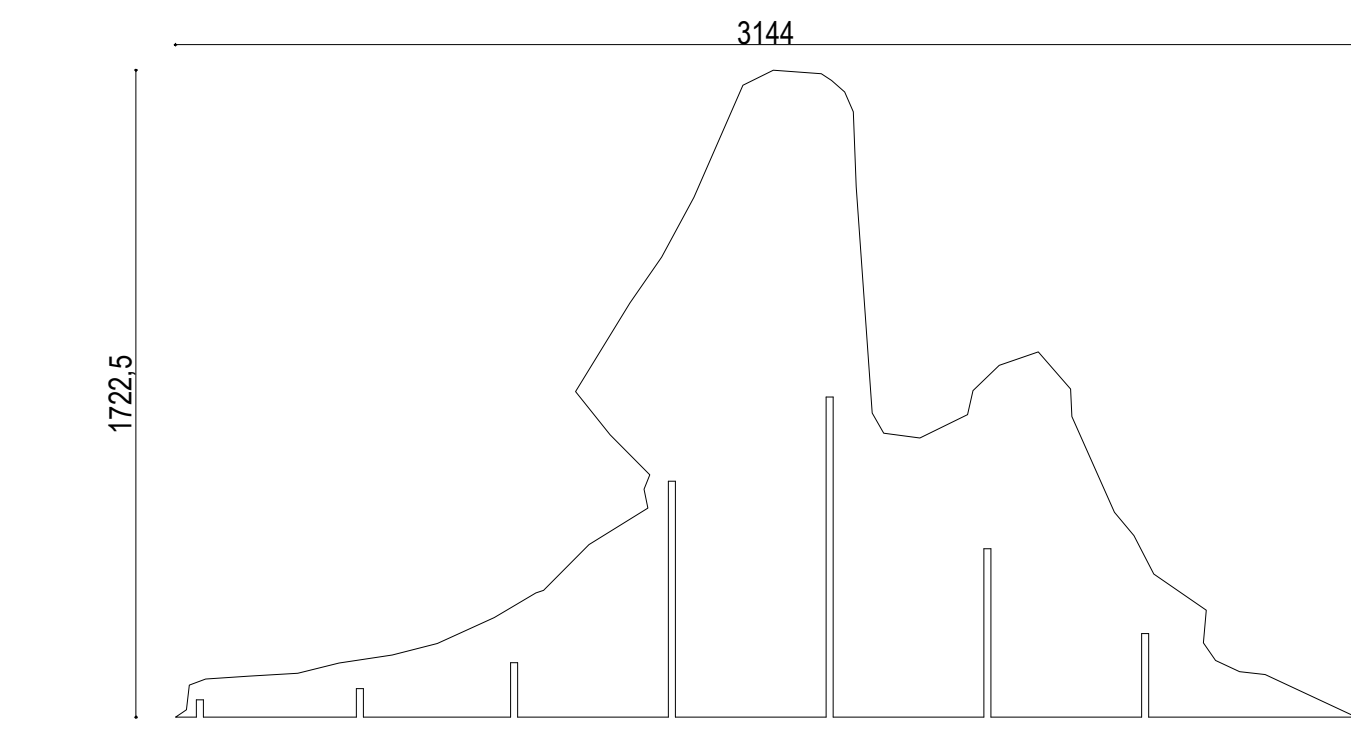

FRAME 15

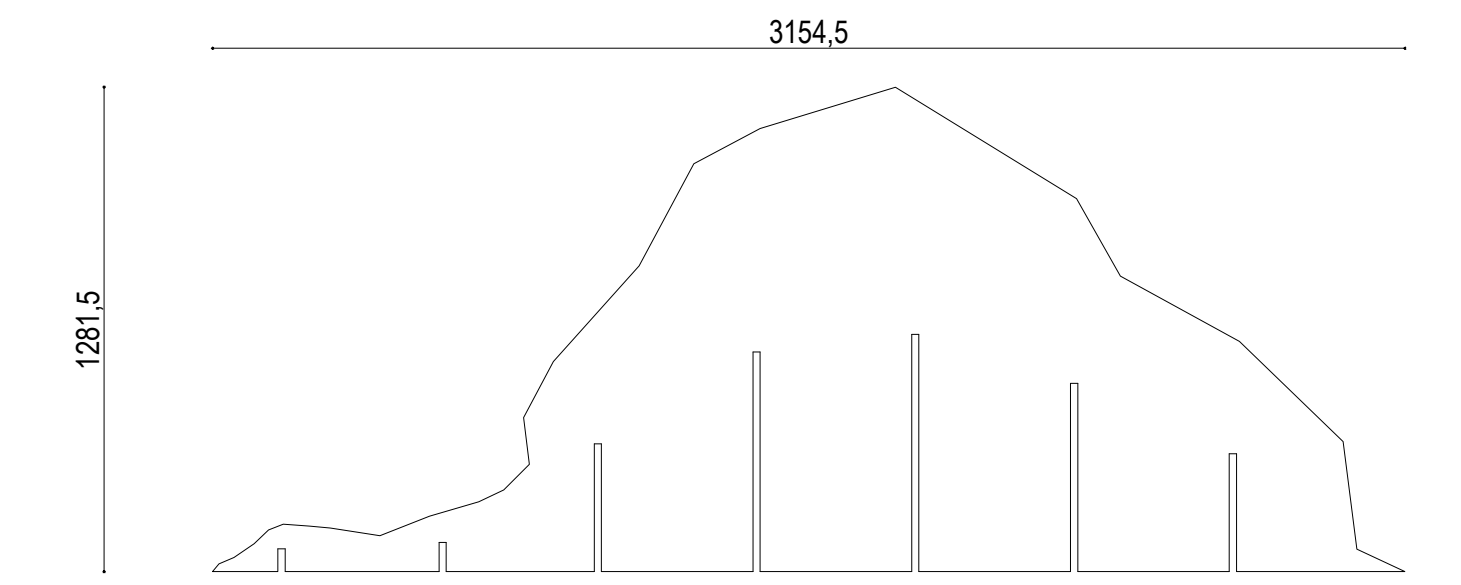

FRAME 13

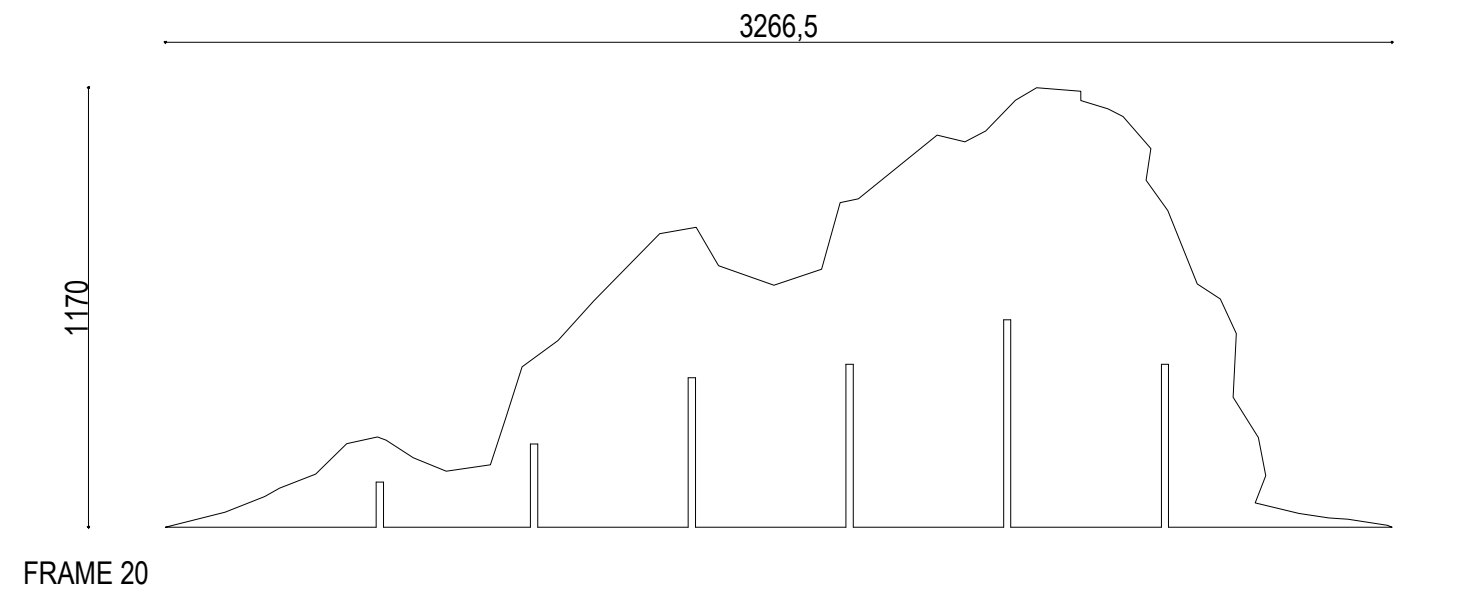
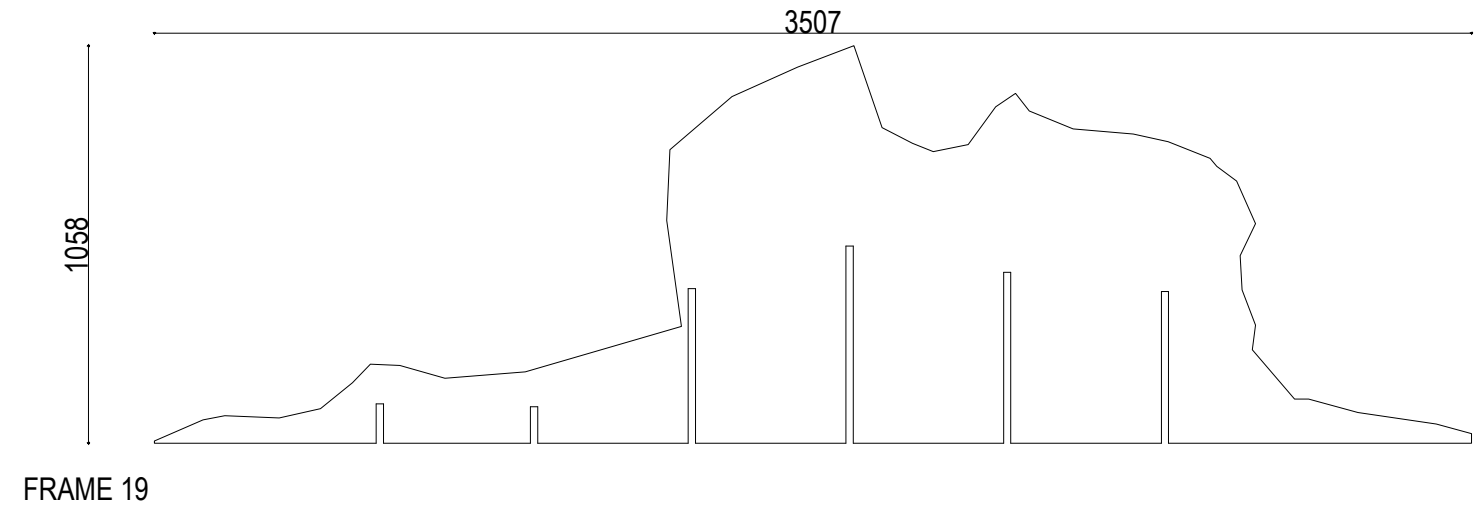
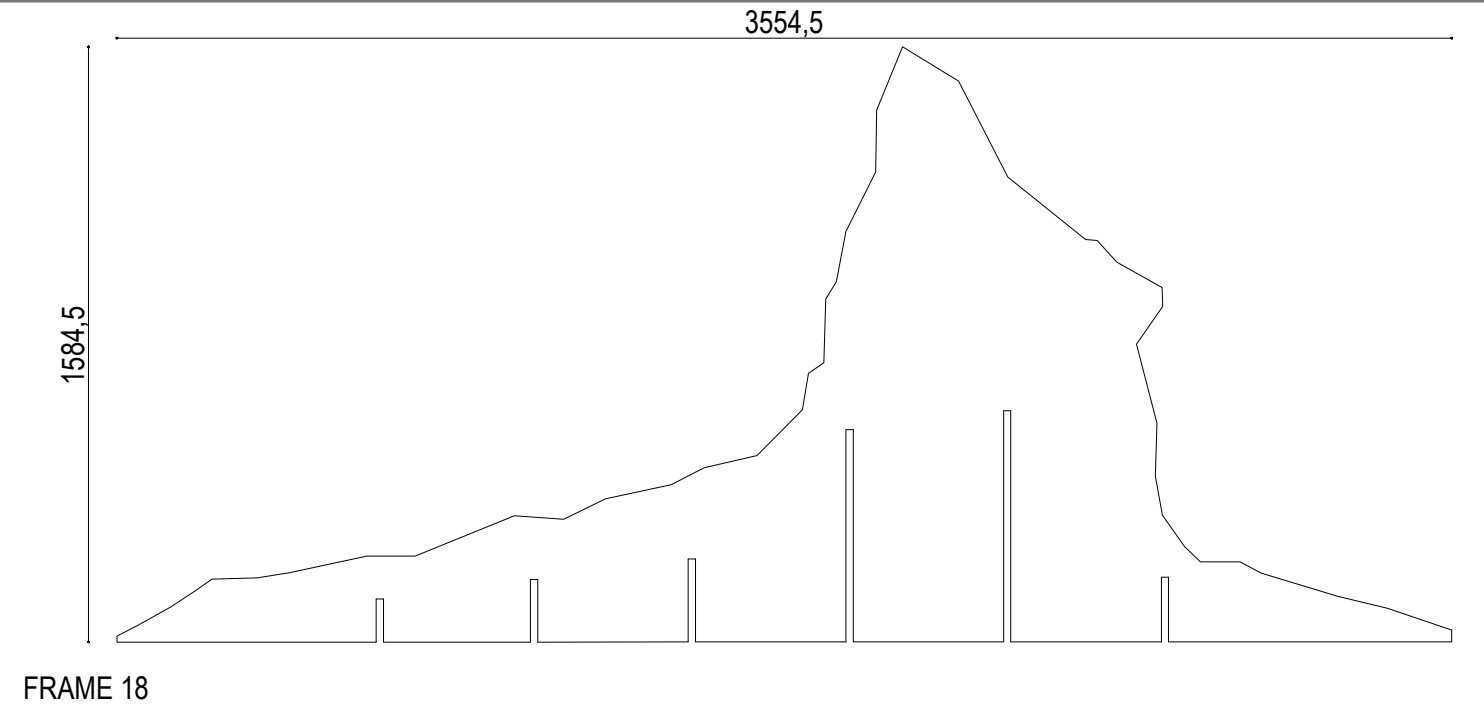
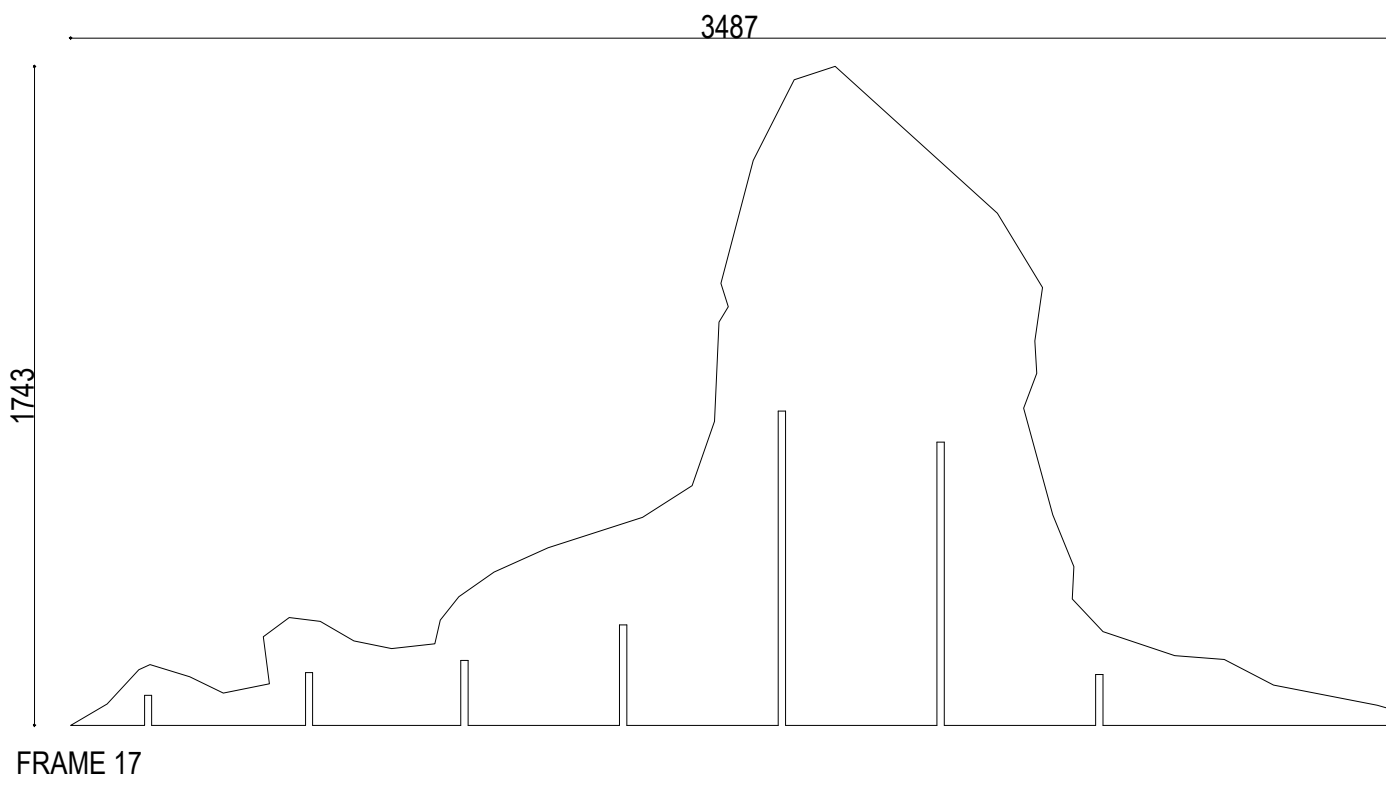
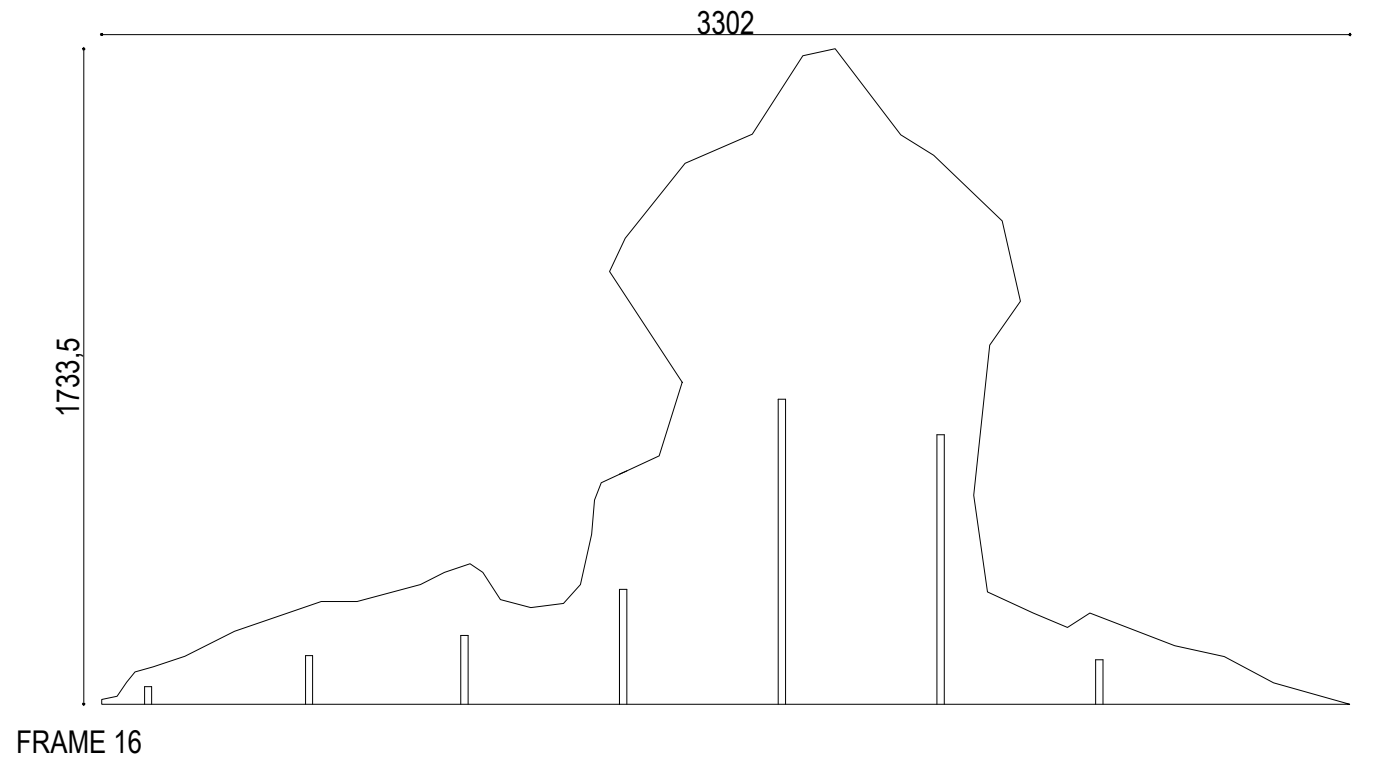

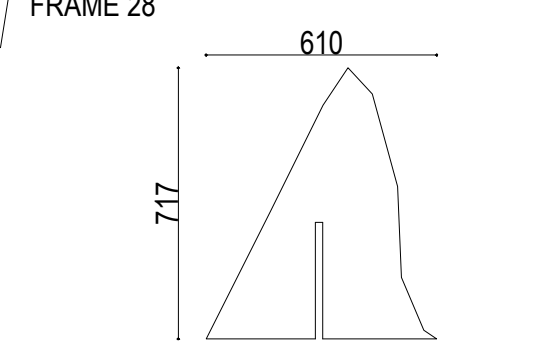
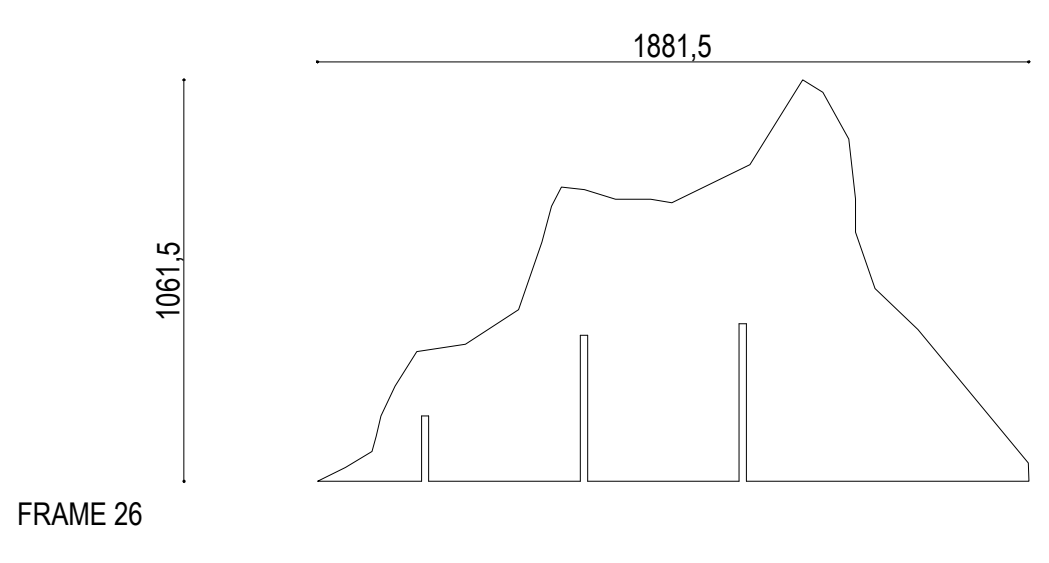
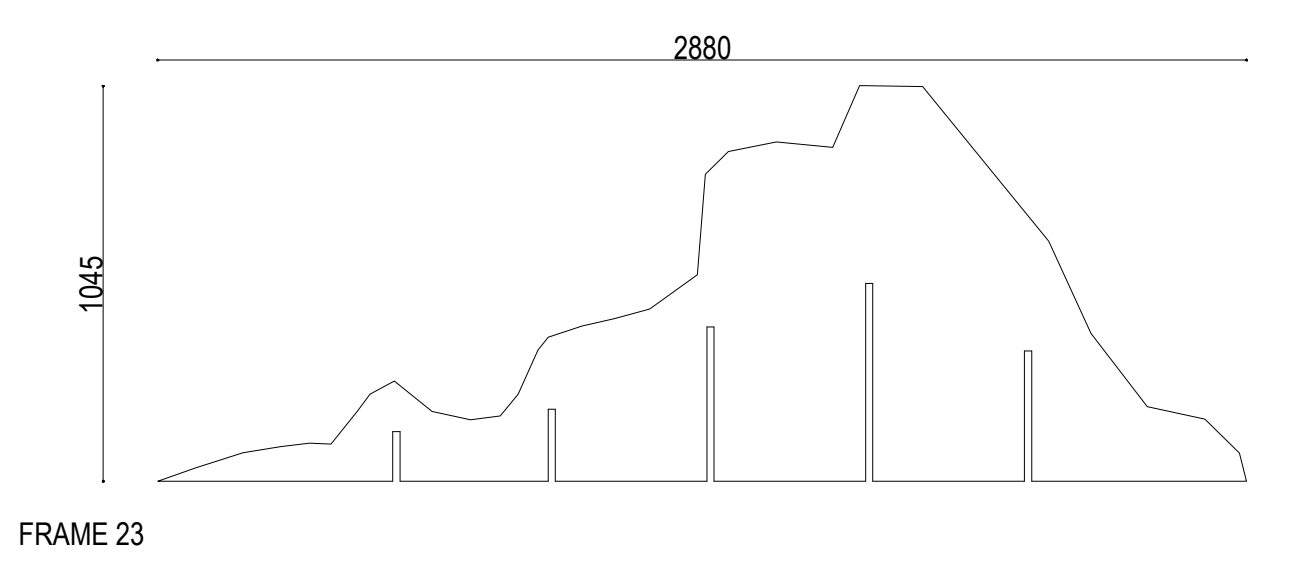
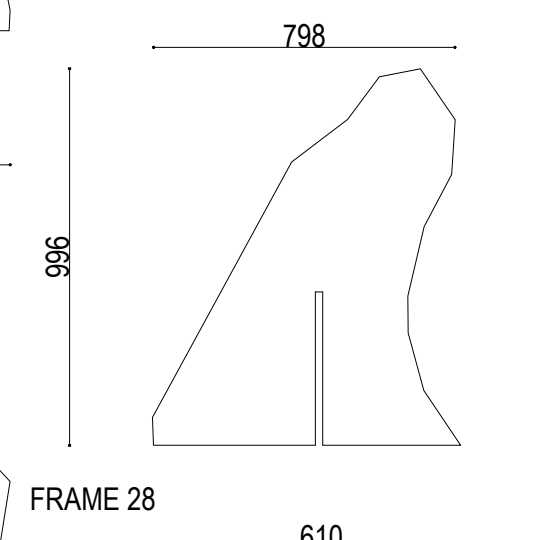
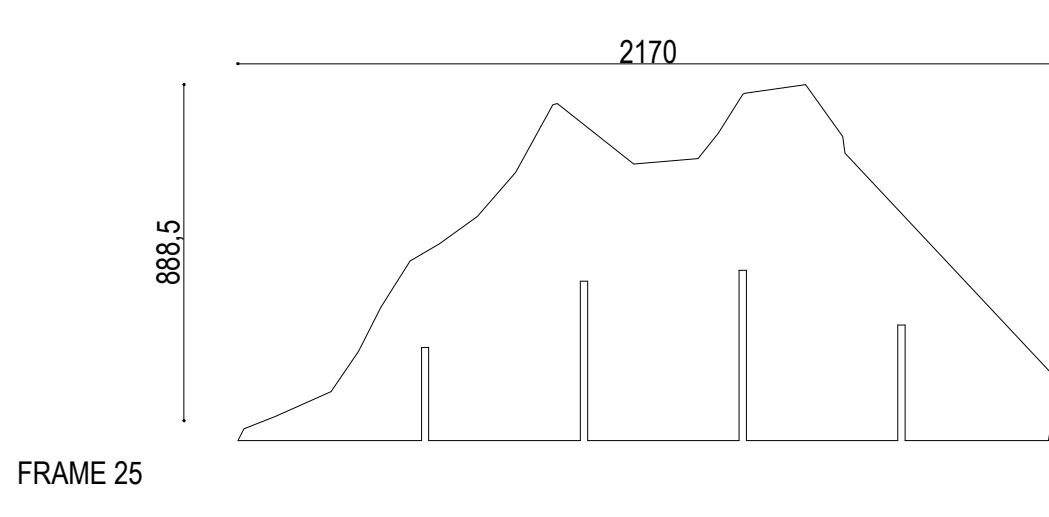
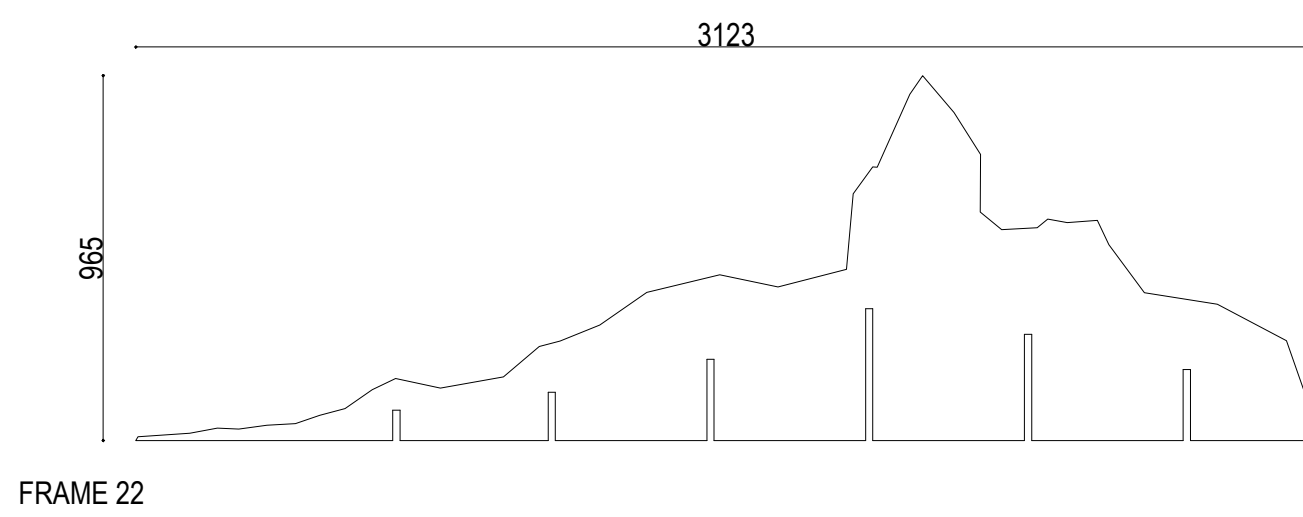
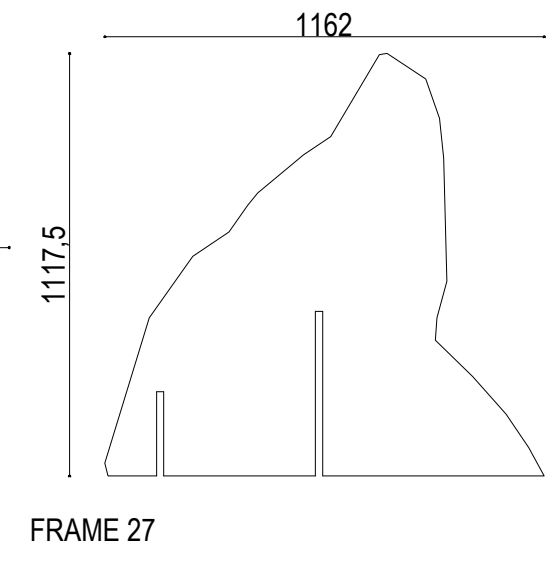
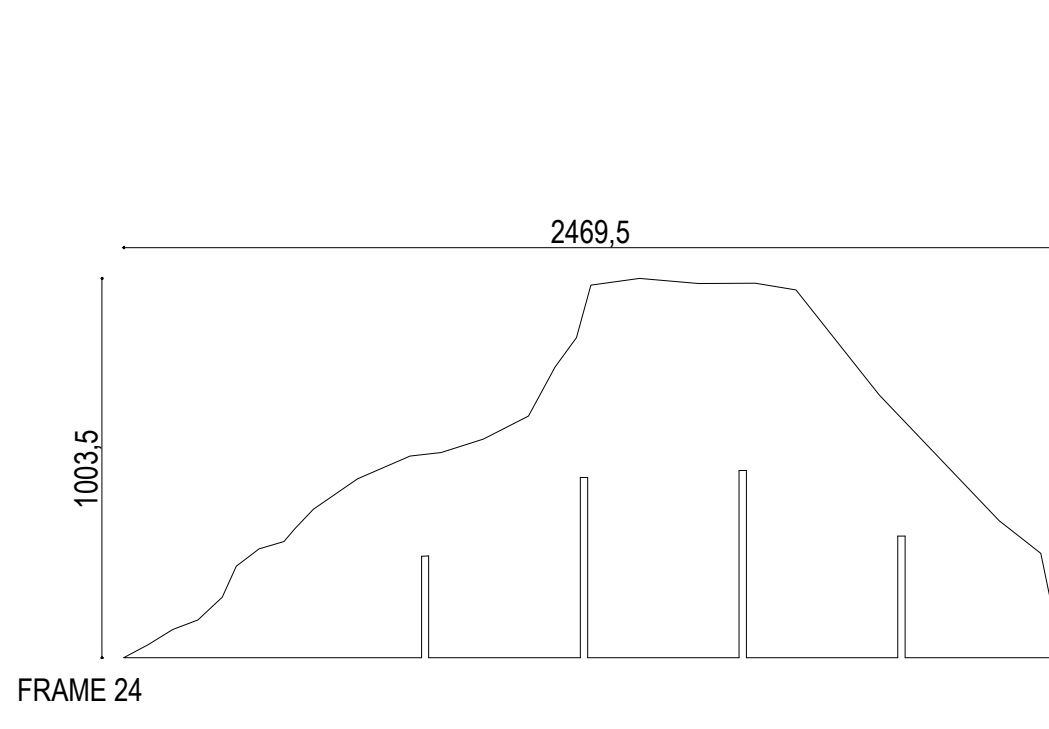
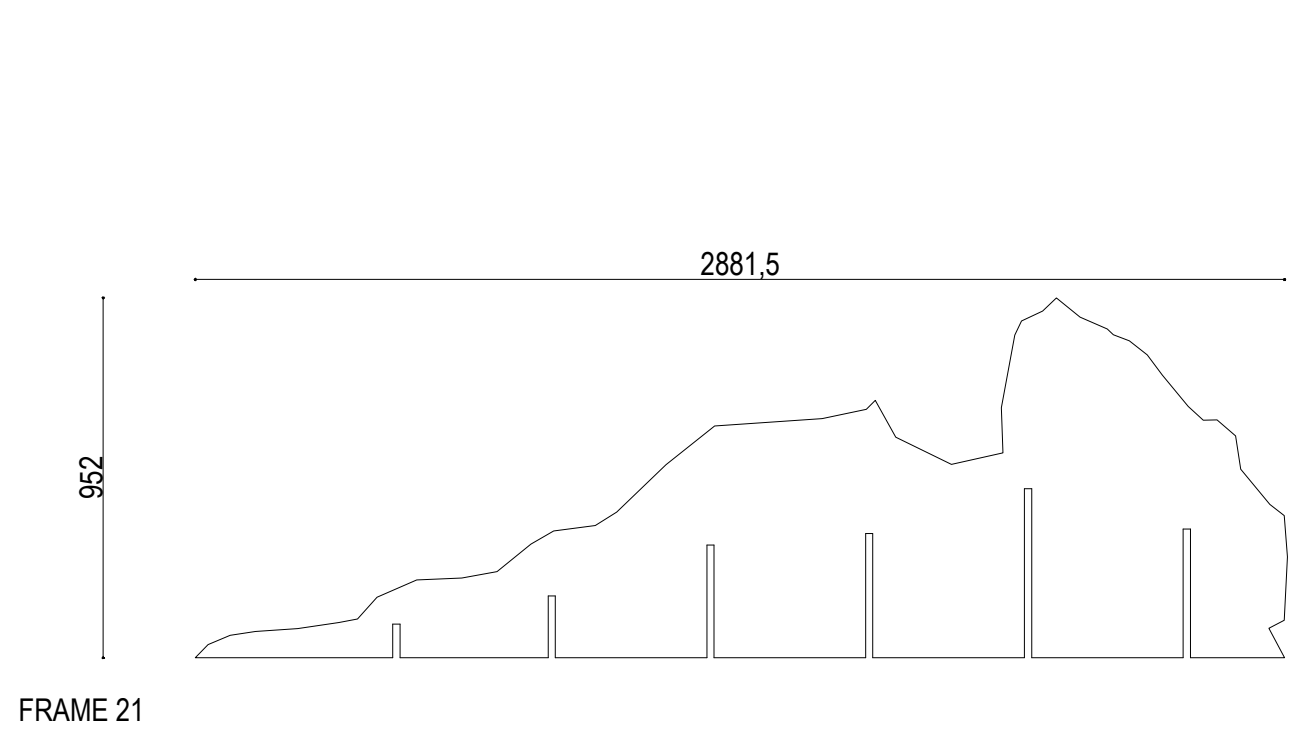

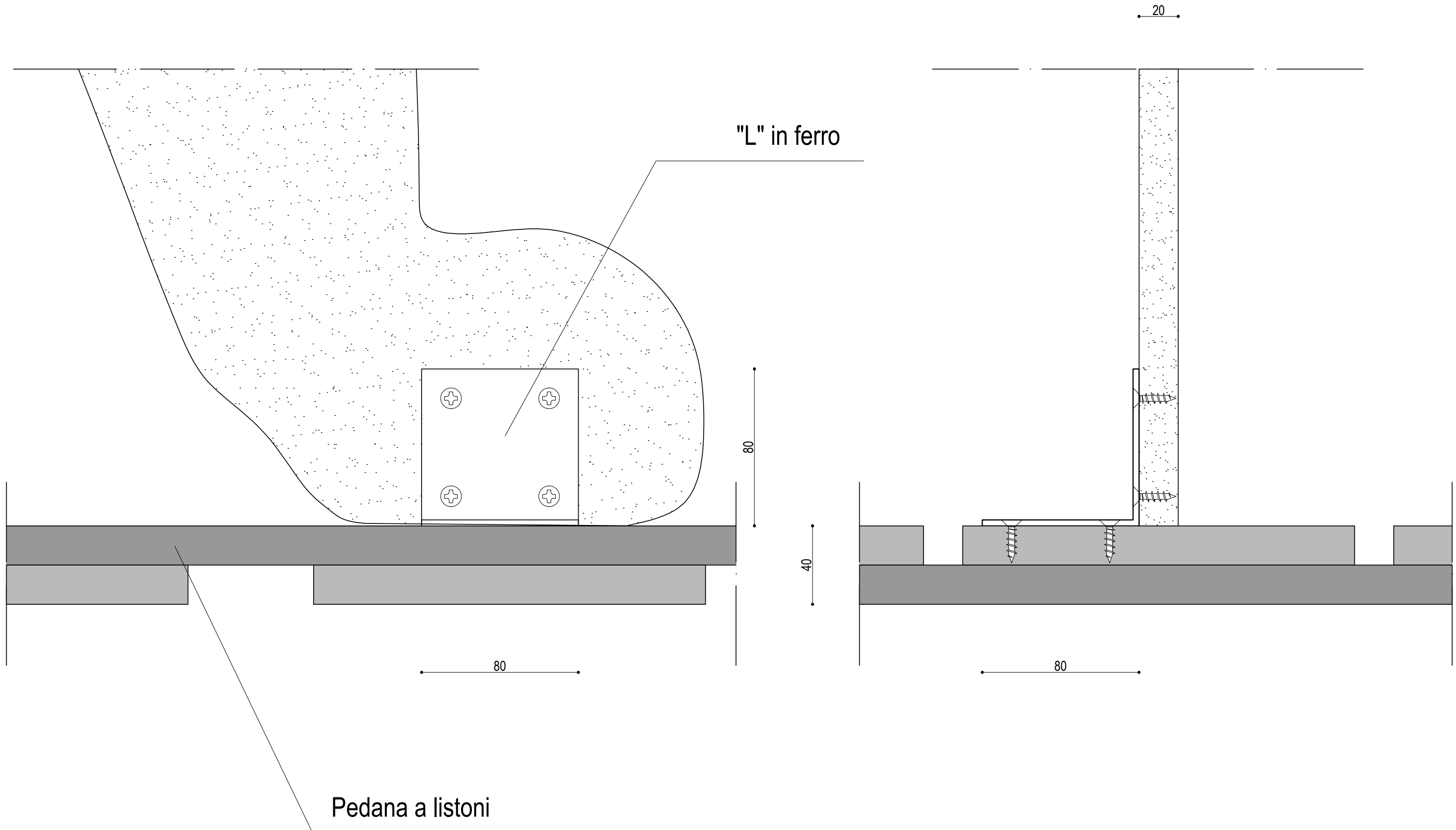

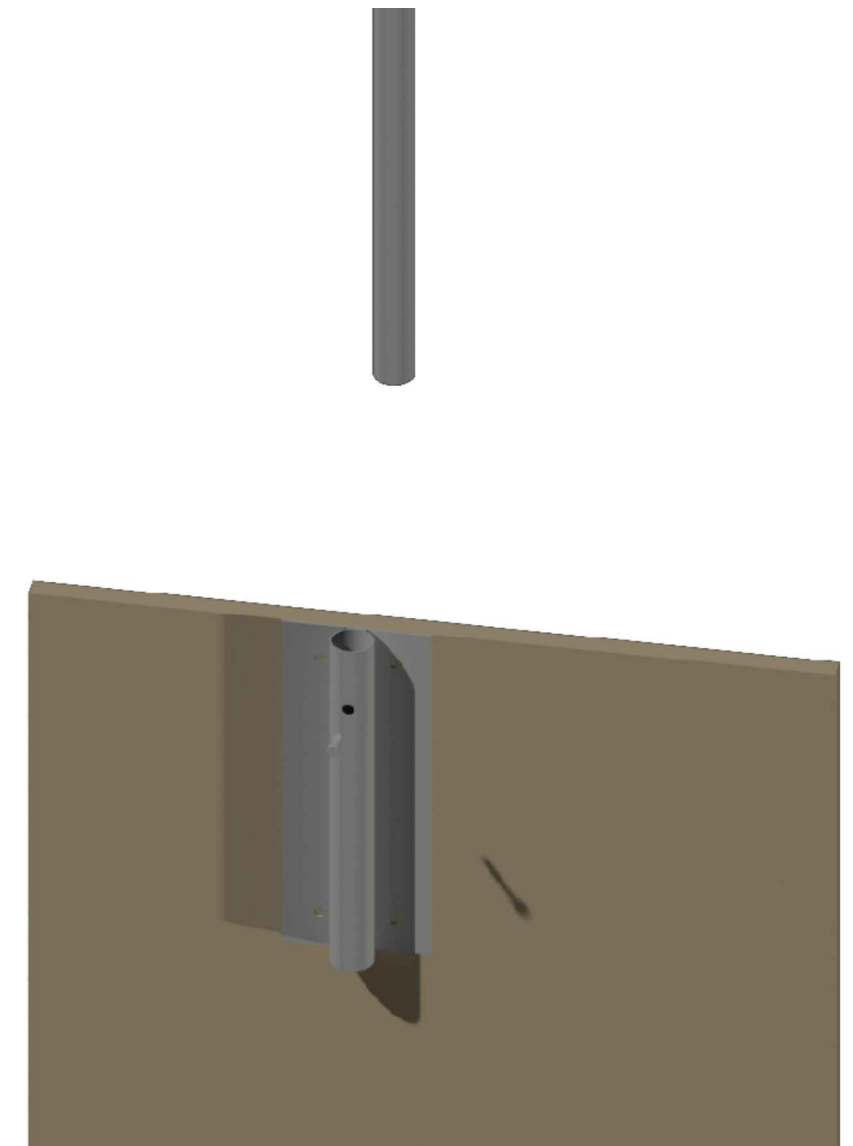
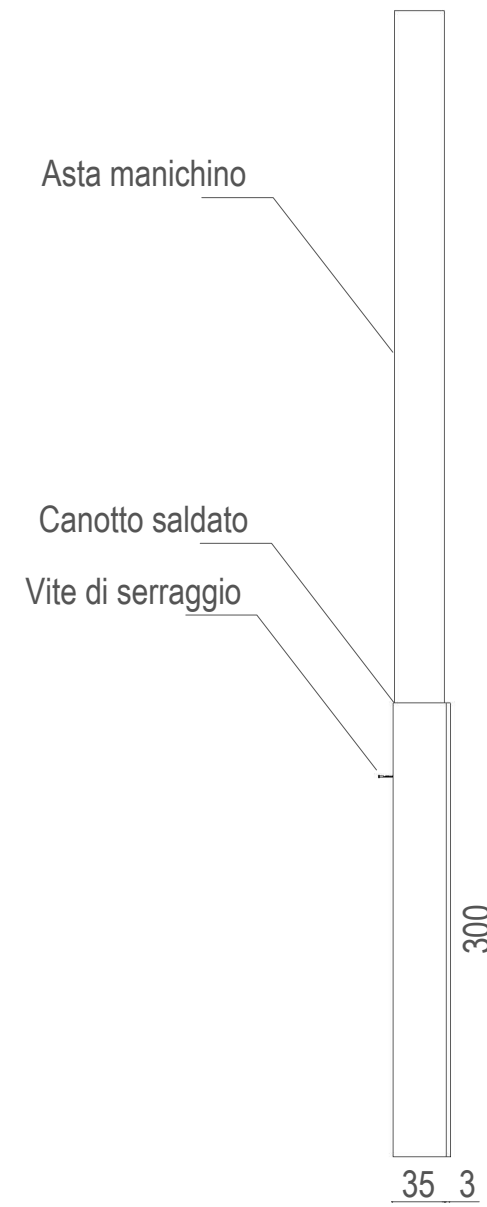
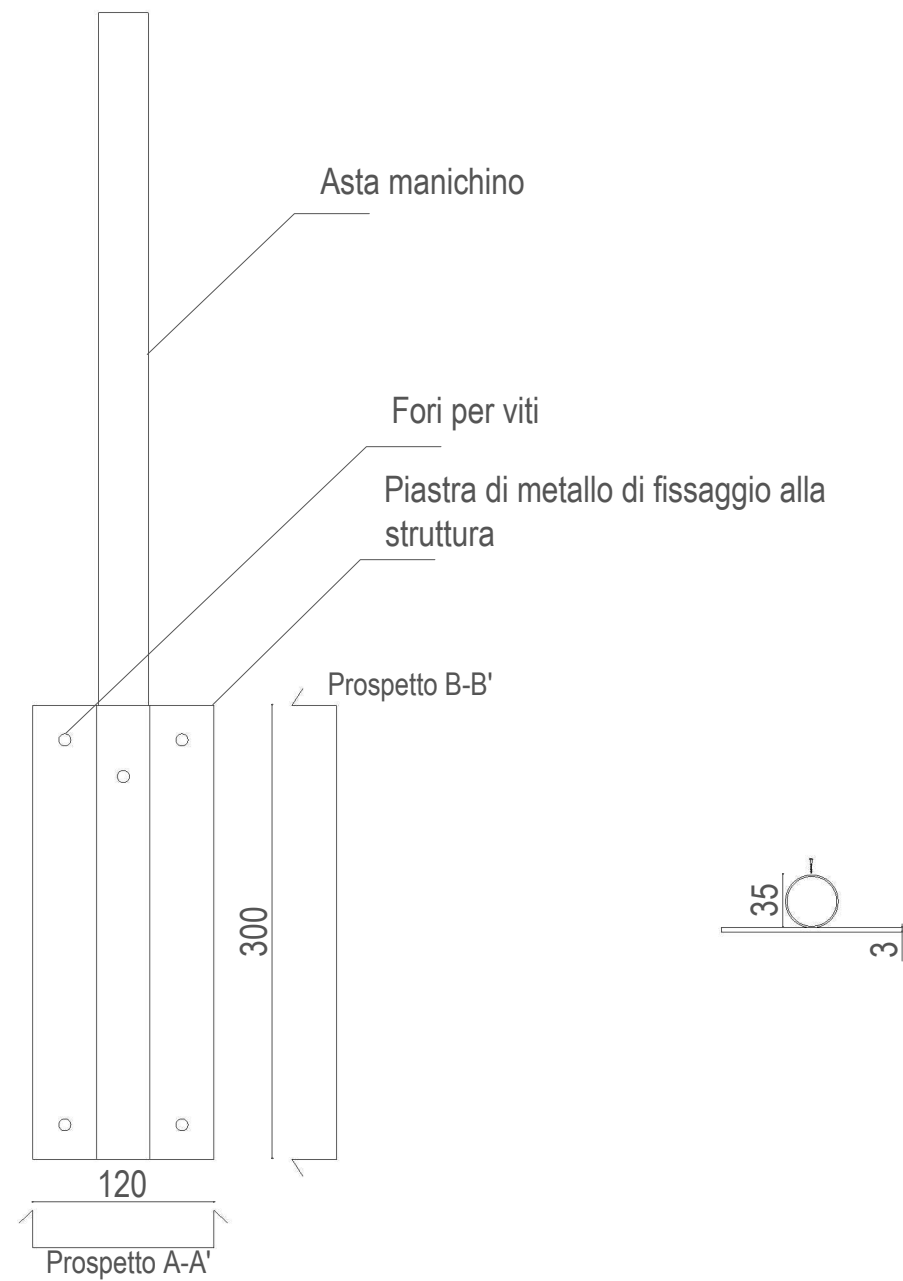

PIANTA

PROSPETTO A-A'

PROSPETTO B-B'

MODELLO 3D

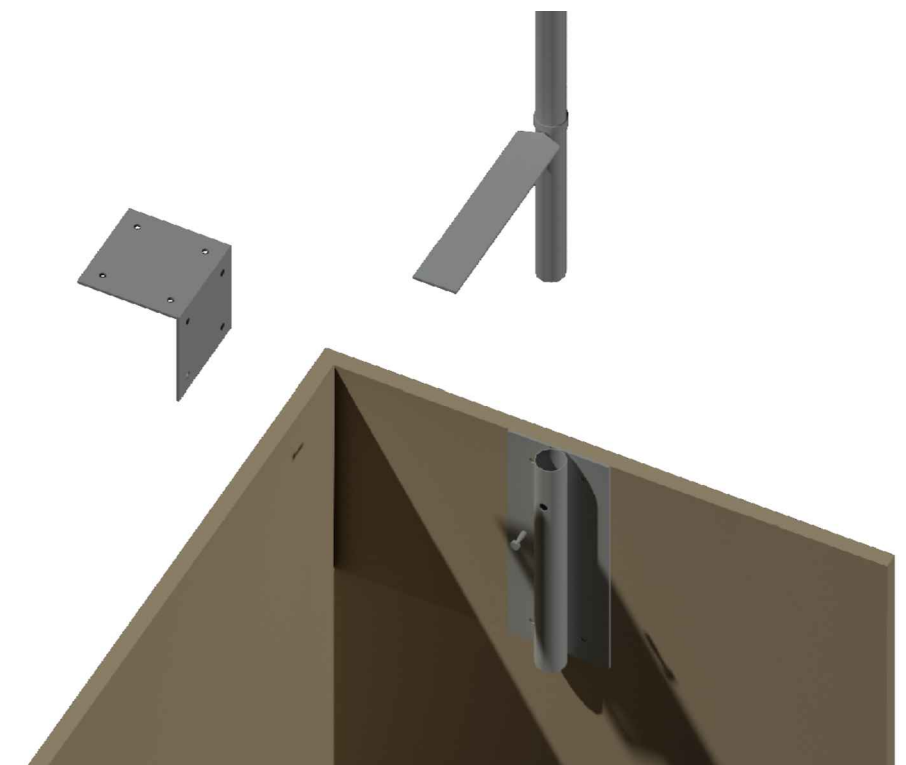
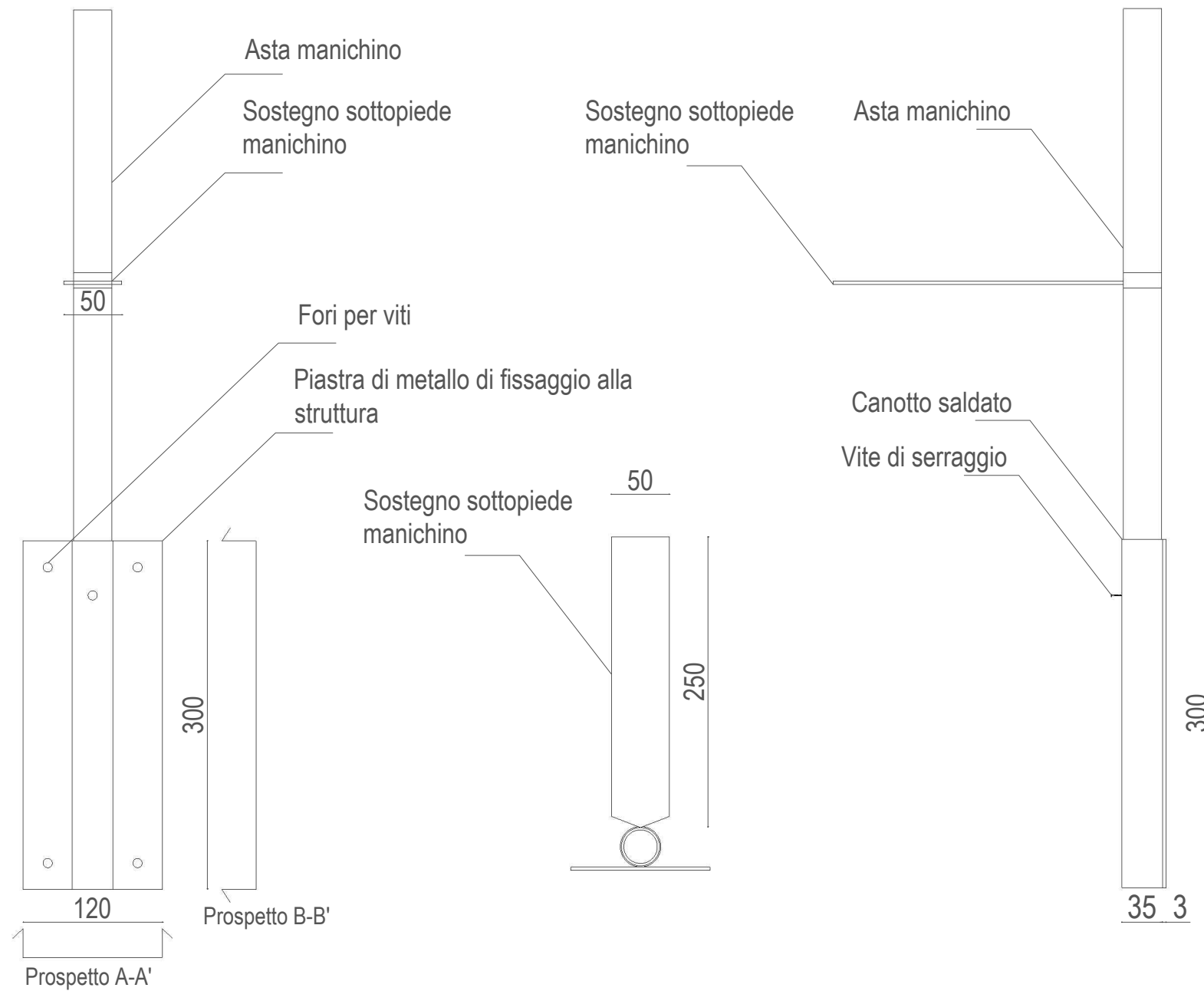

PIANTA

PROSPETTO A-A'

PROSPETTO B-B'

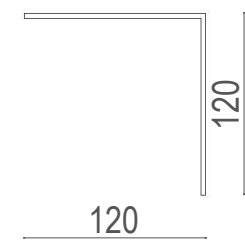
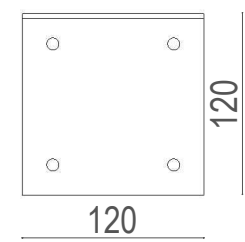
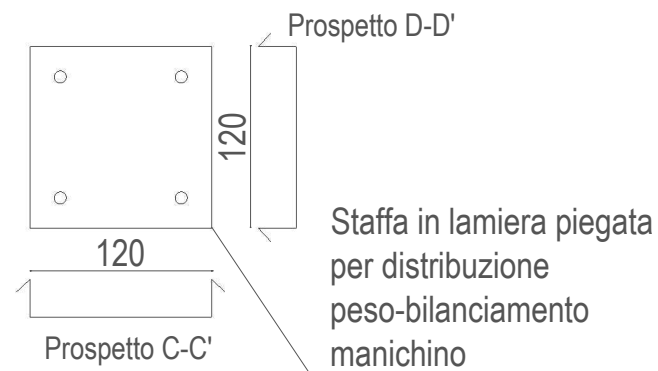

PIANTA

PROSPETTO C-C'

PROSPETTO D-D'

MODELLO 3D

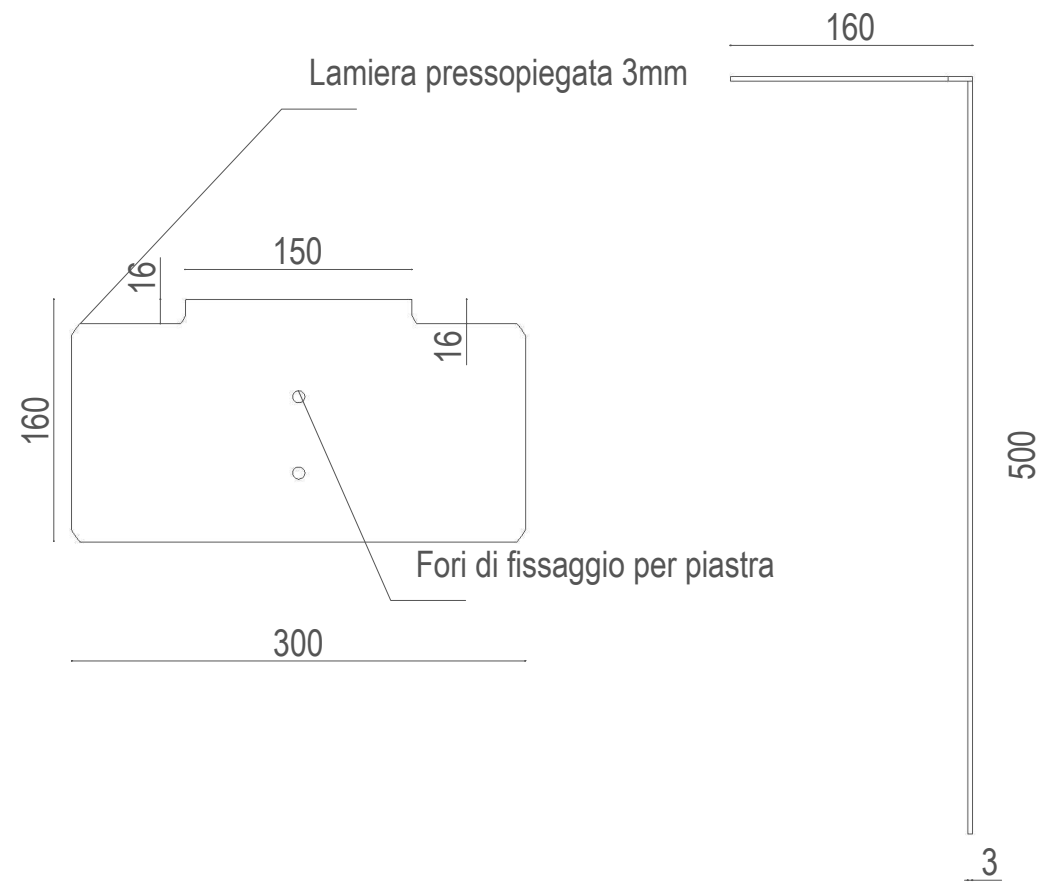
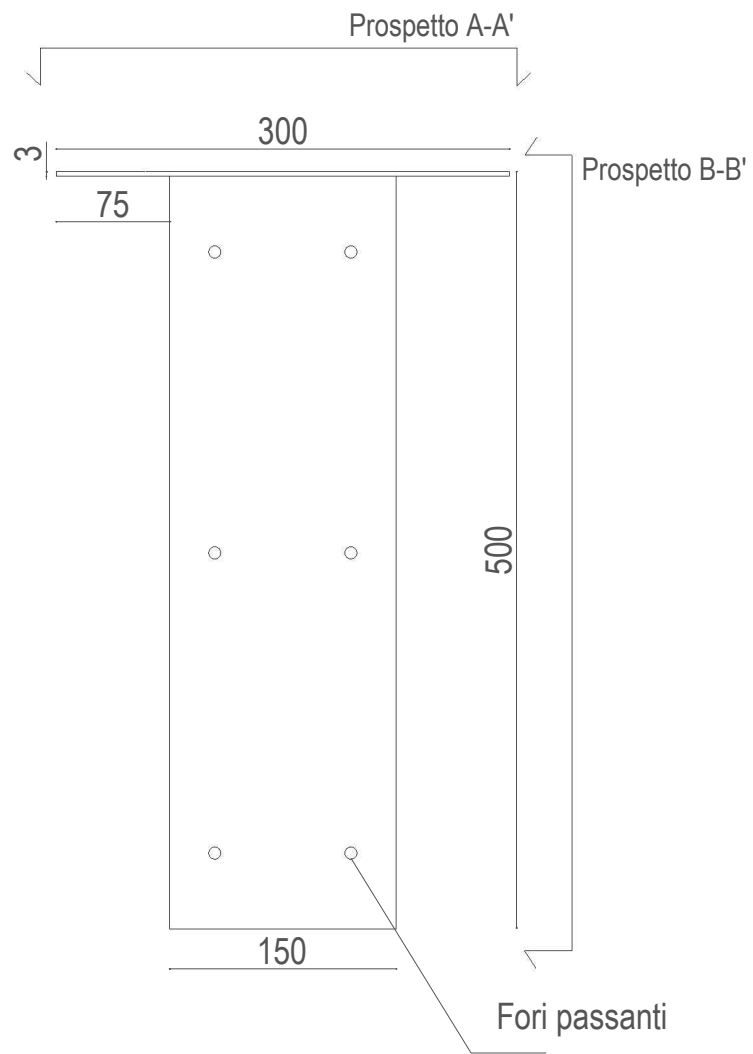

Staffa doppia per sostegno piastra manichino

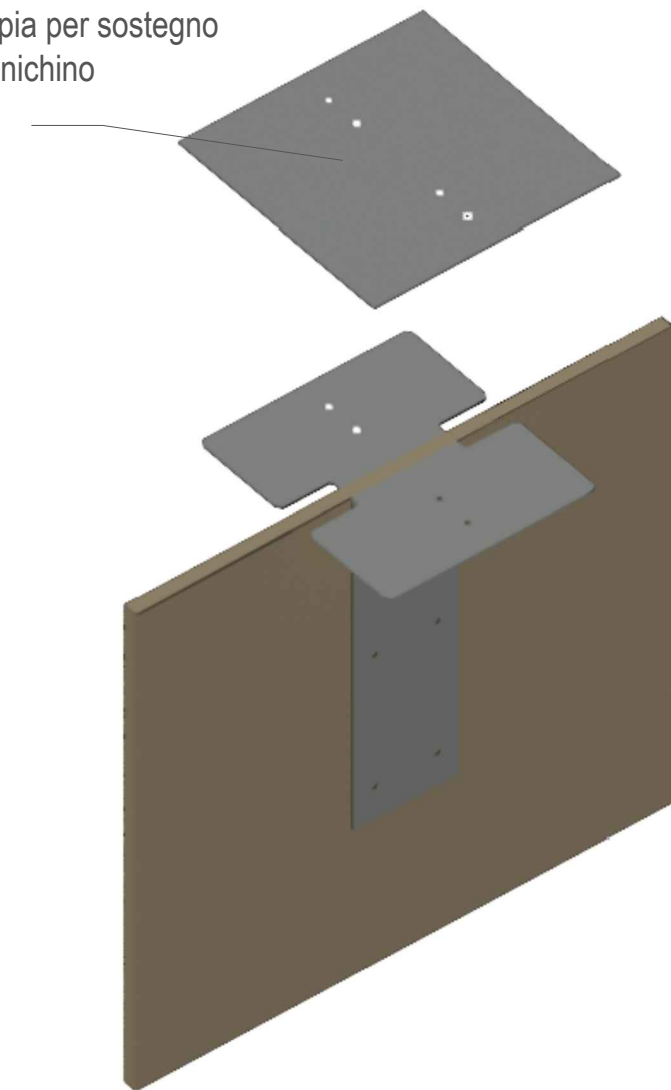

PIANTA

PROSPETTO A-A'

PROSPETTO B-B'

MODELLO 3D

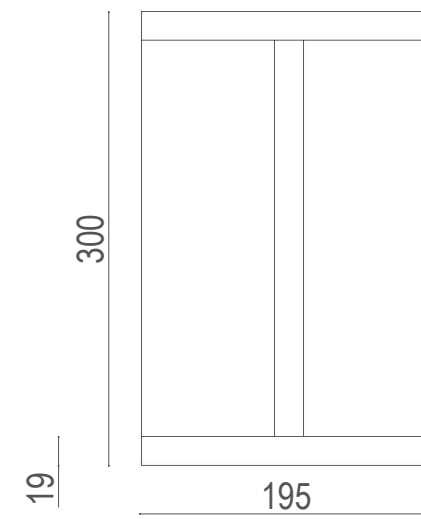
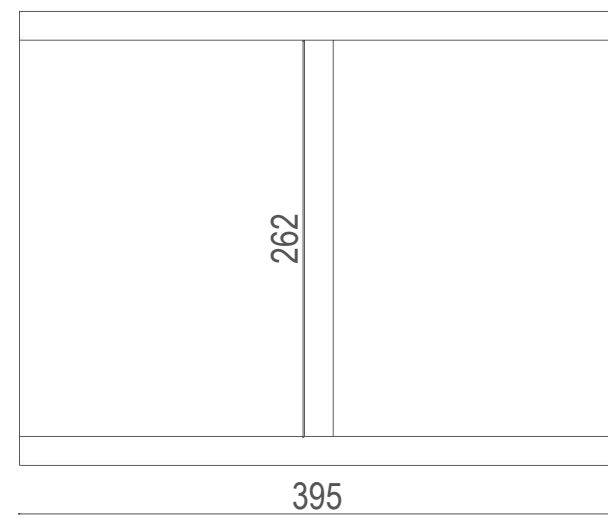
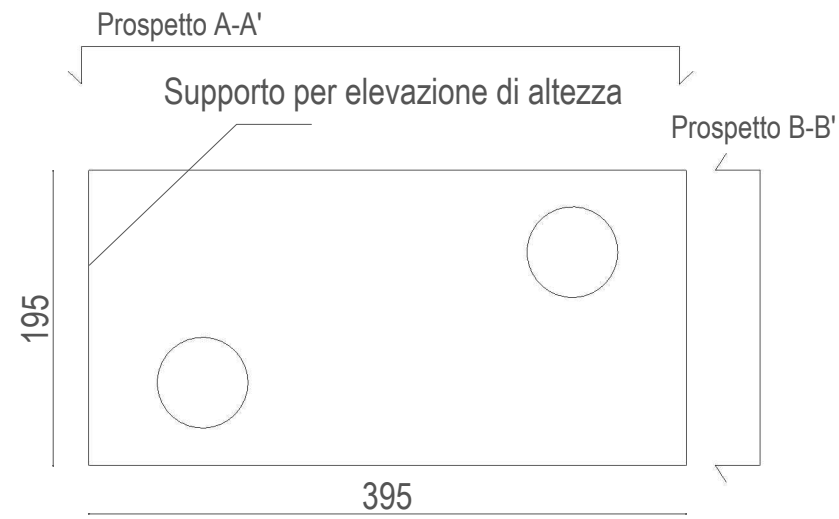

PIANTA

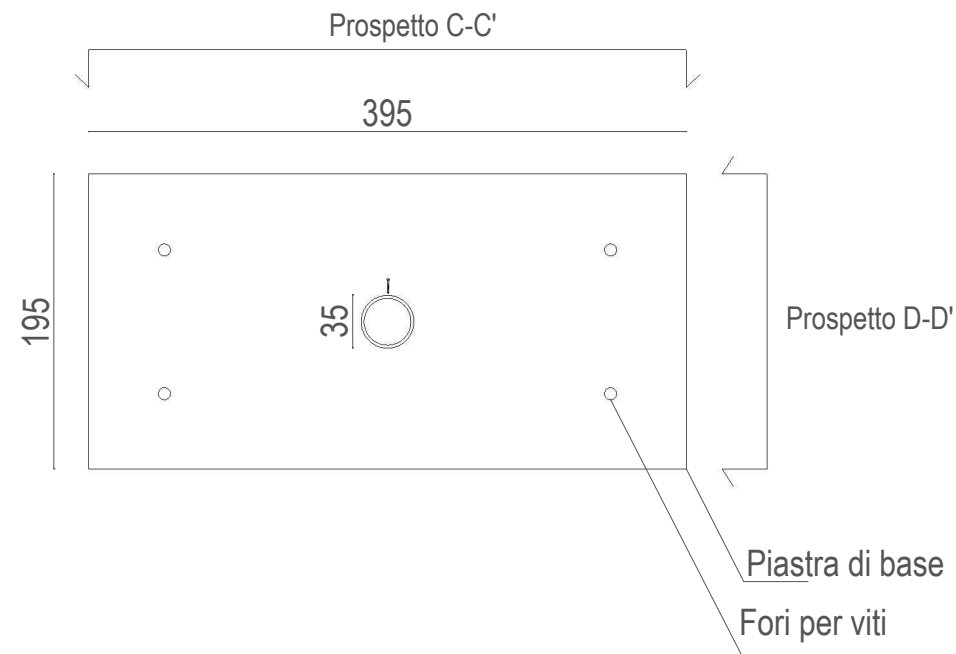

PROSPETTO A-A'

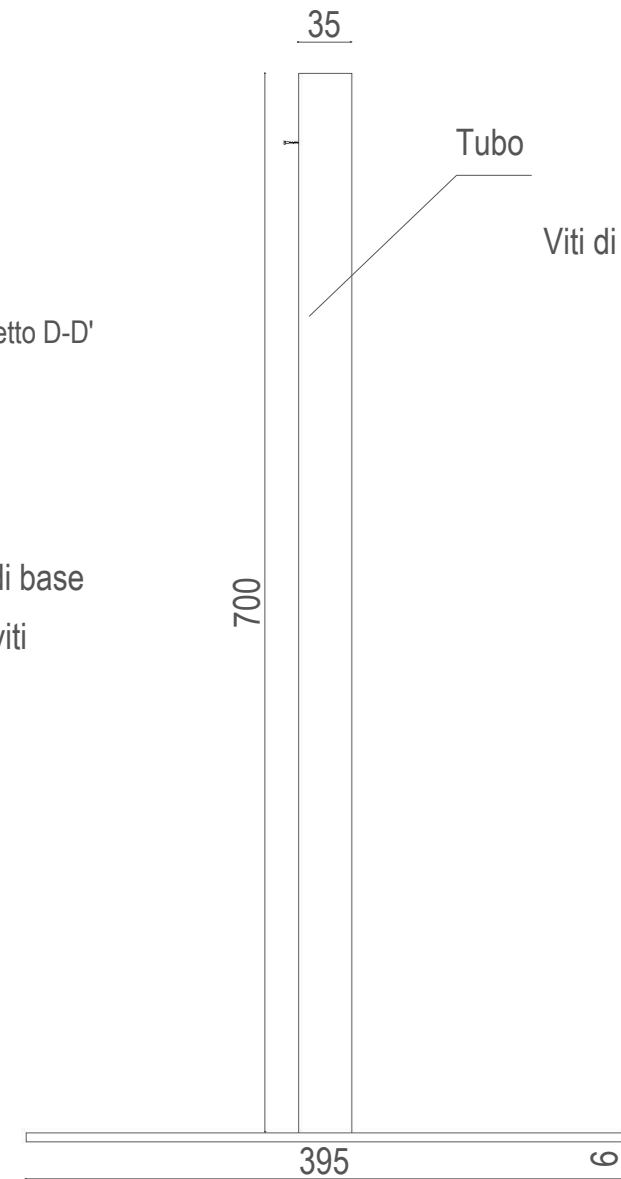

PROSPETTO B-B'

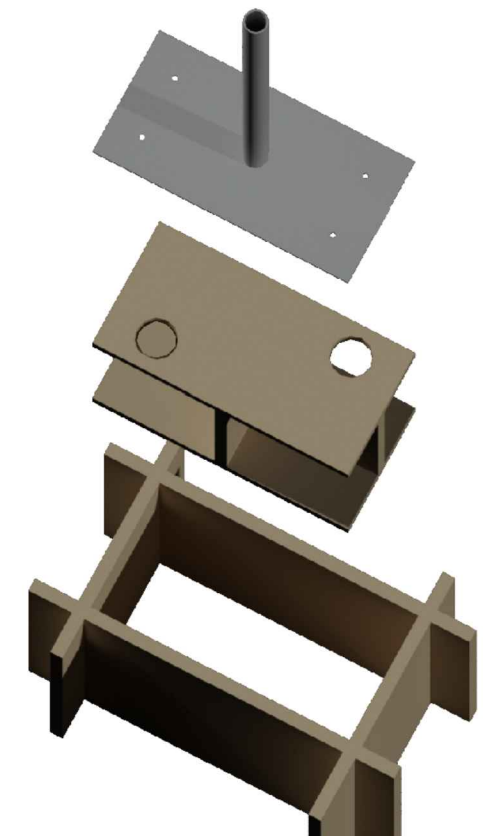
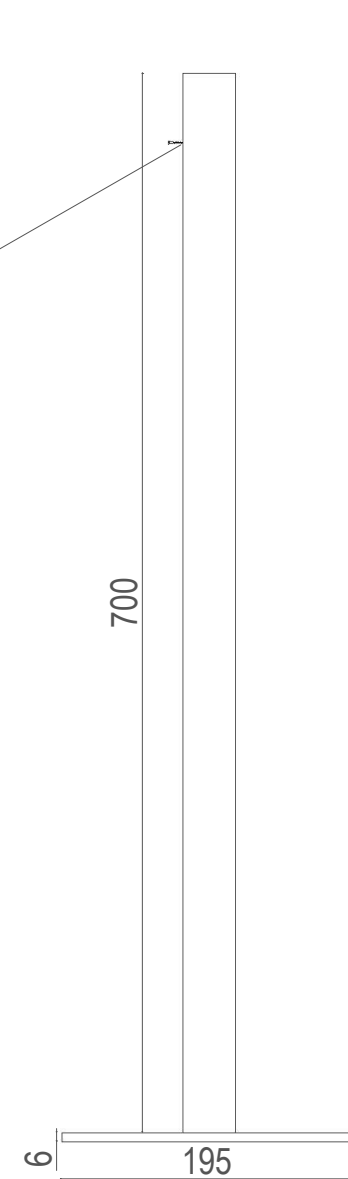

PIANTA

PROSPETTO C-C'

PROSPETTO D-D'

MODELLO 3D

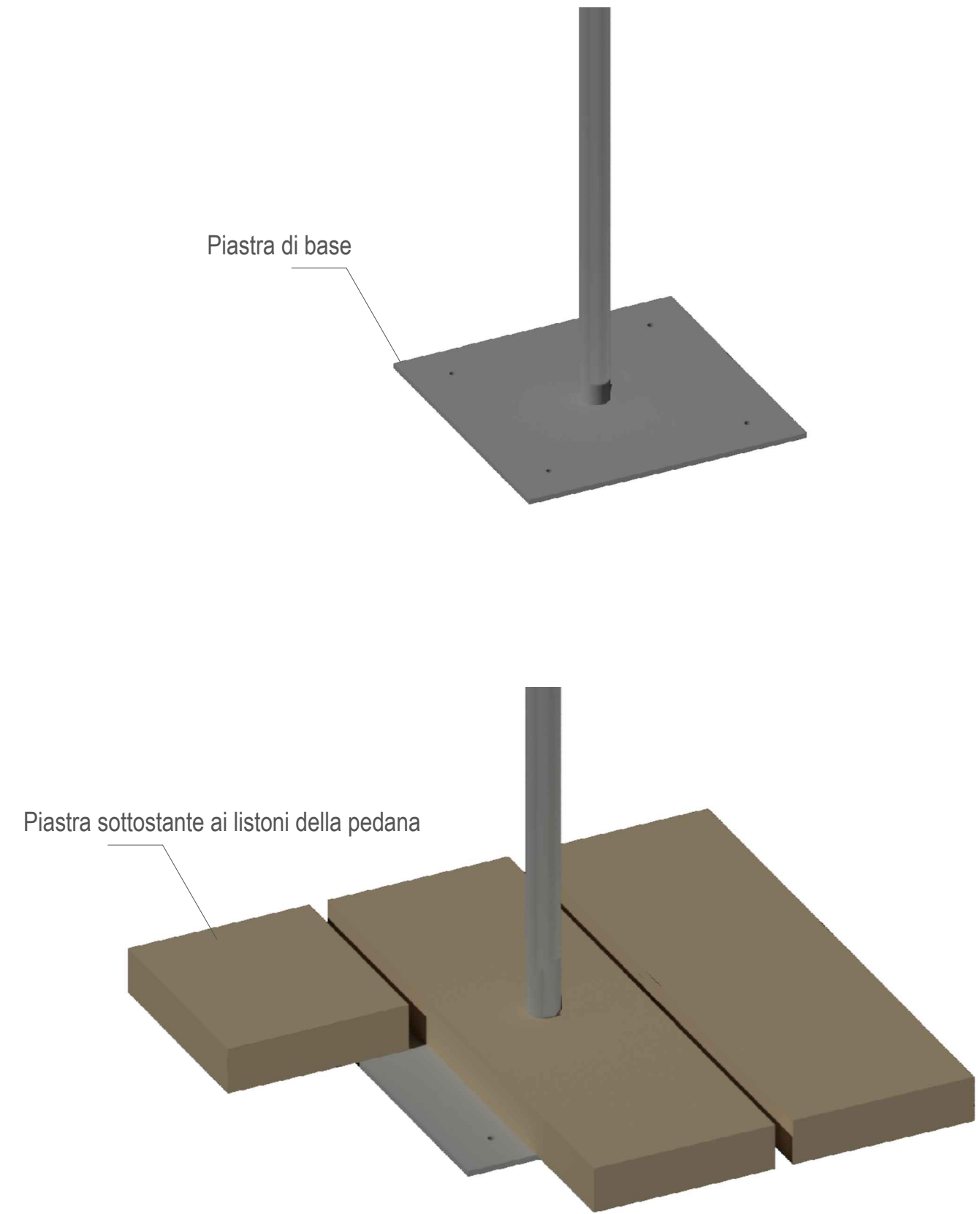
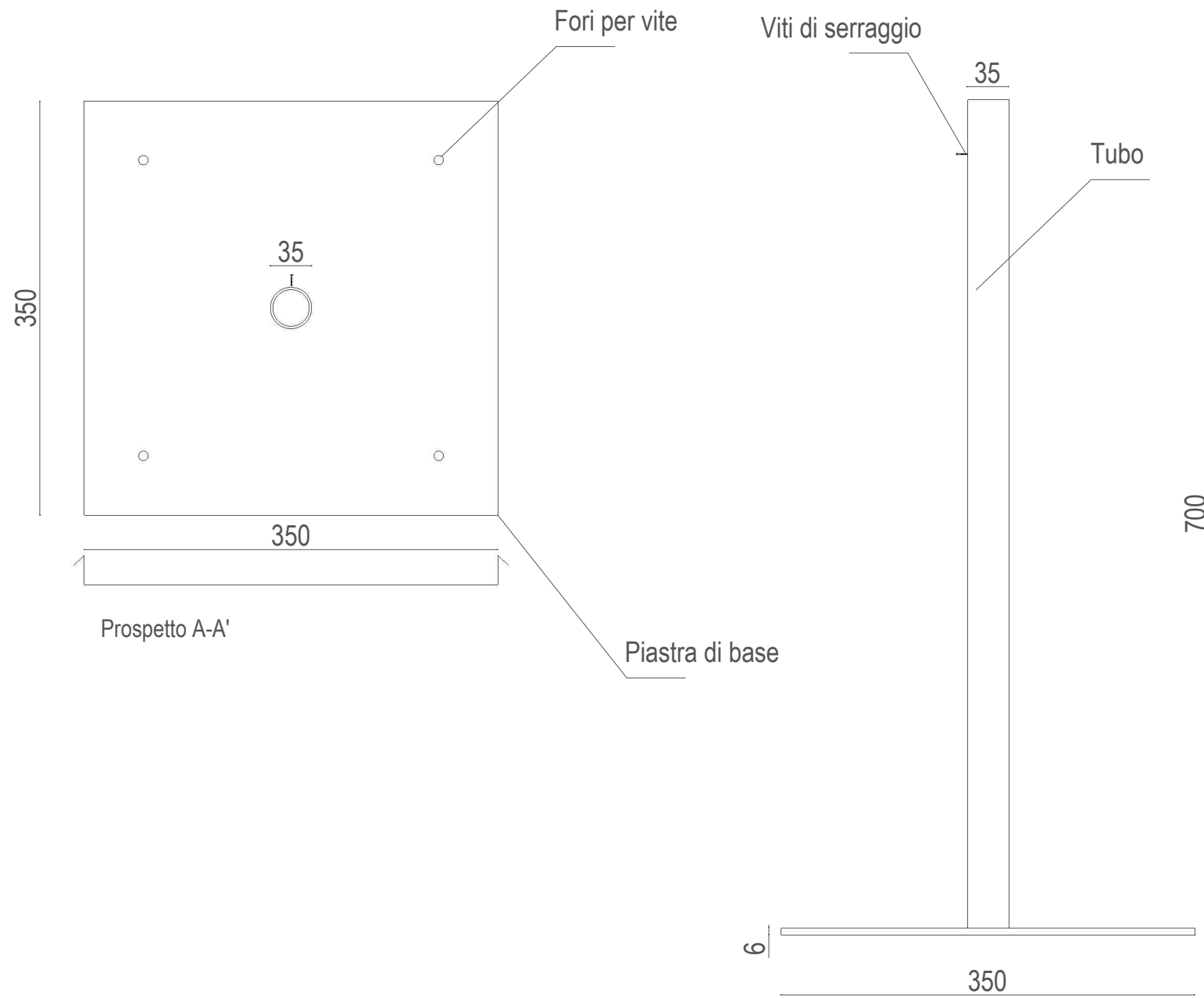

PIANTA

PROSPETTO A-A'

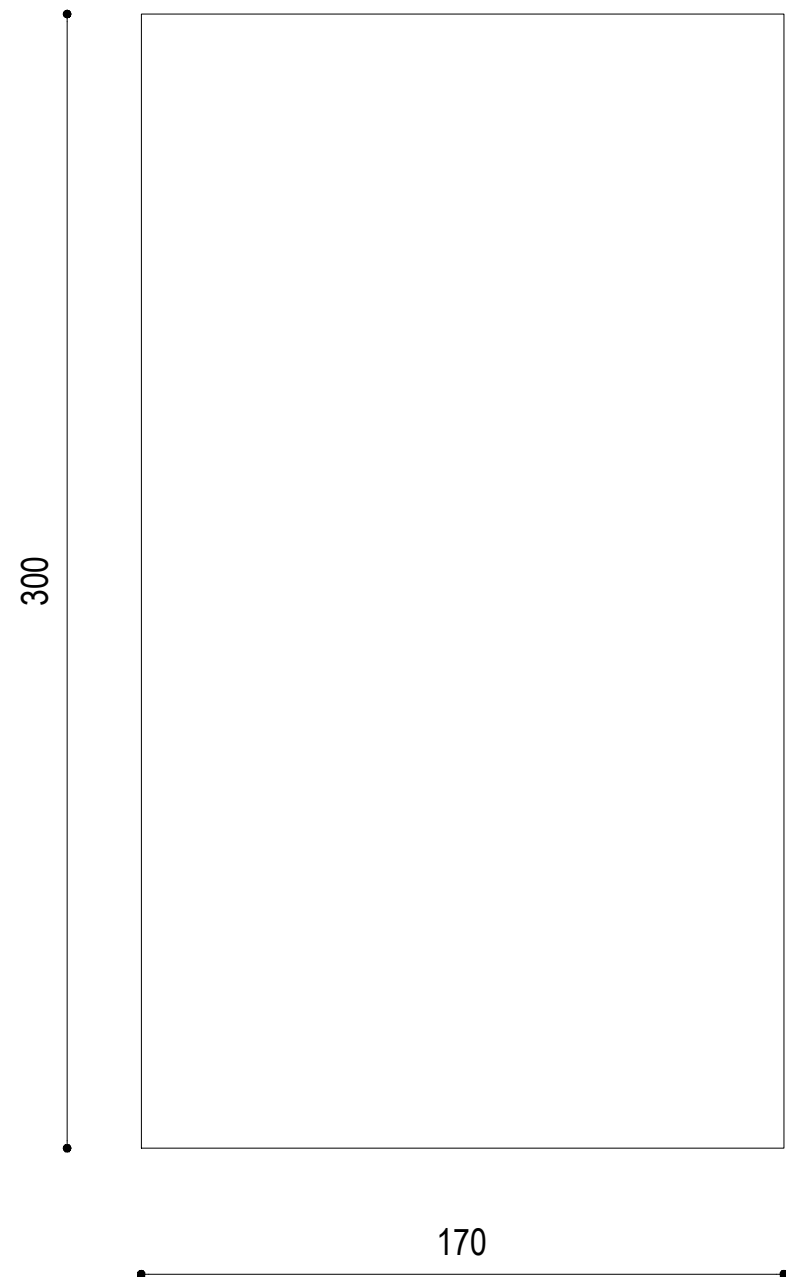

Totem ingresso- esistente- H=300 cm
 Struttura lignea rivestita di pannelli di MDF ignifugo 19 mm

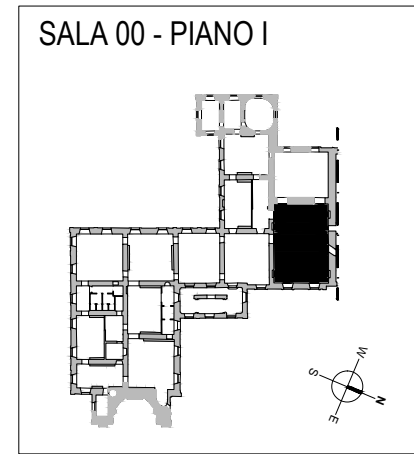

Prospetto A

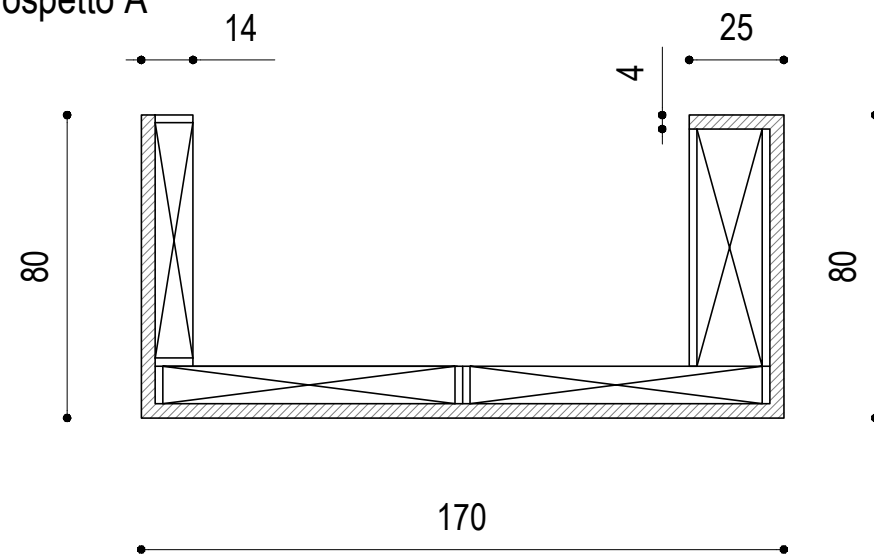

Pianta

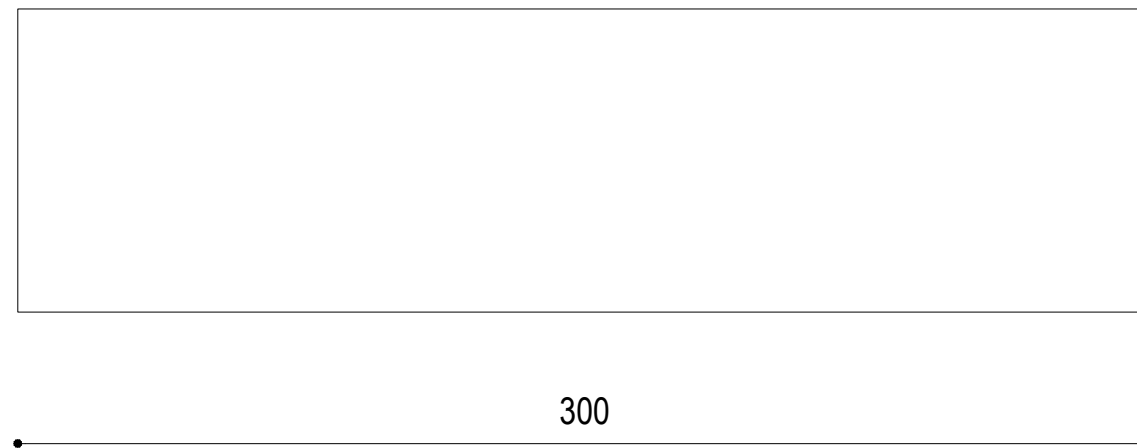

Prospetto B

Pianta

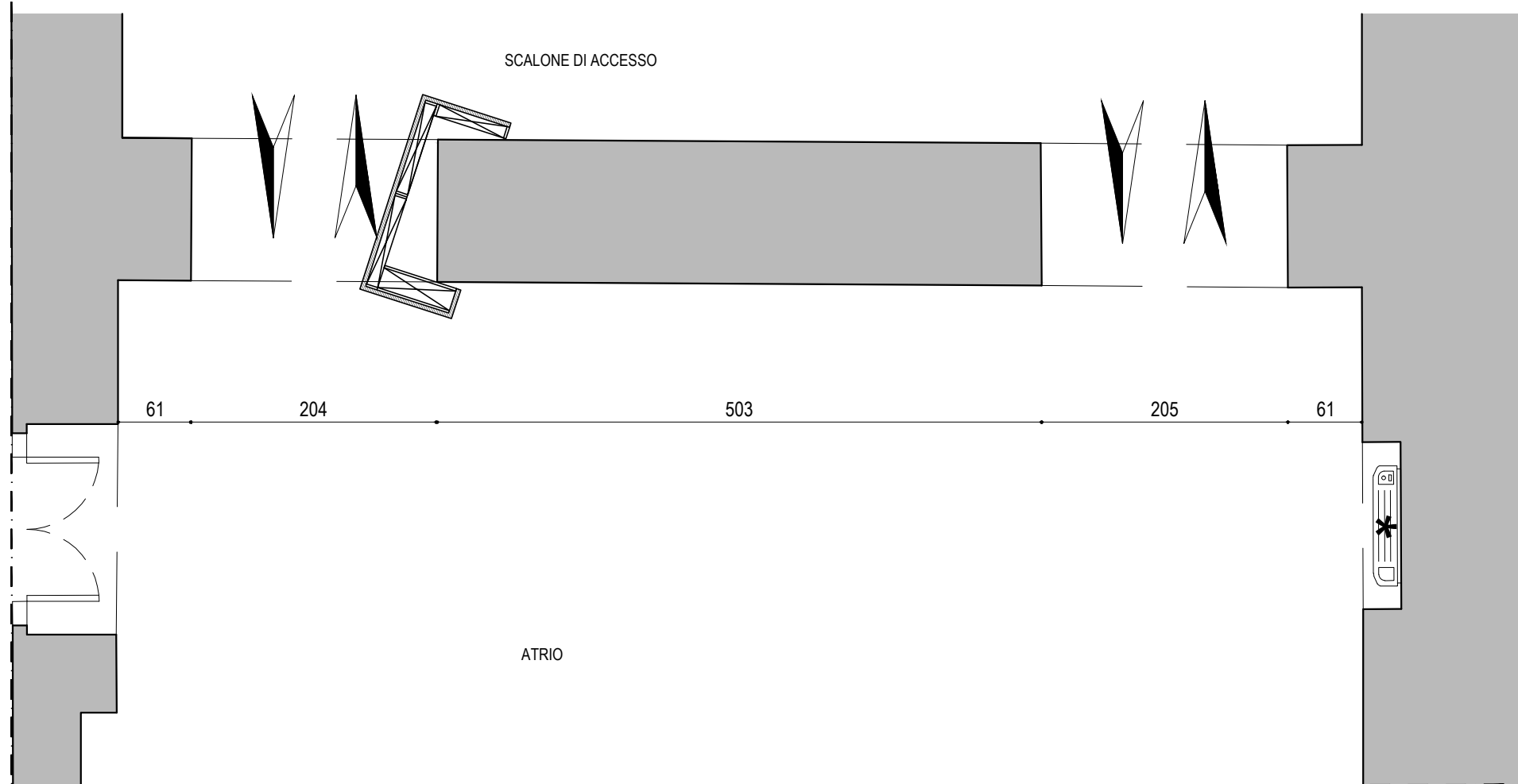

Sezione A-A'

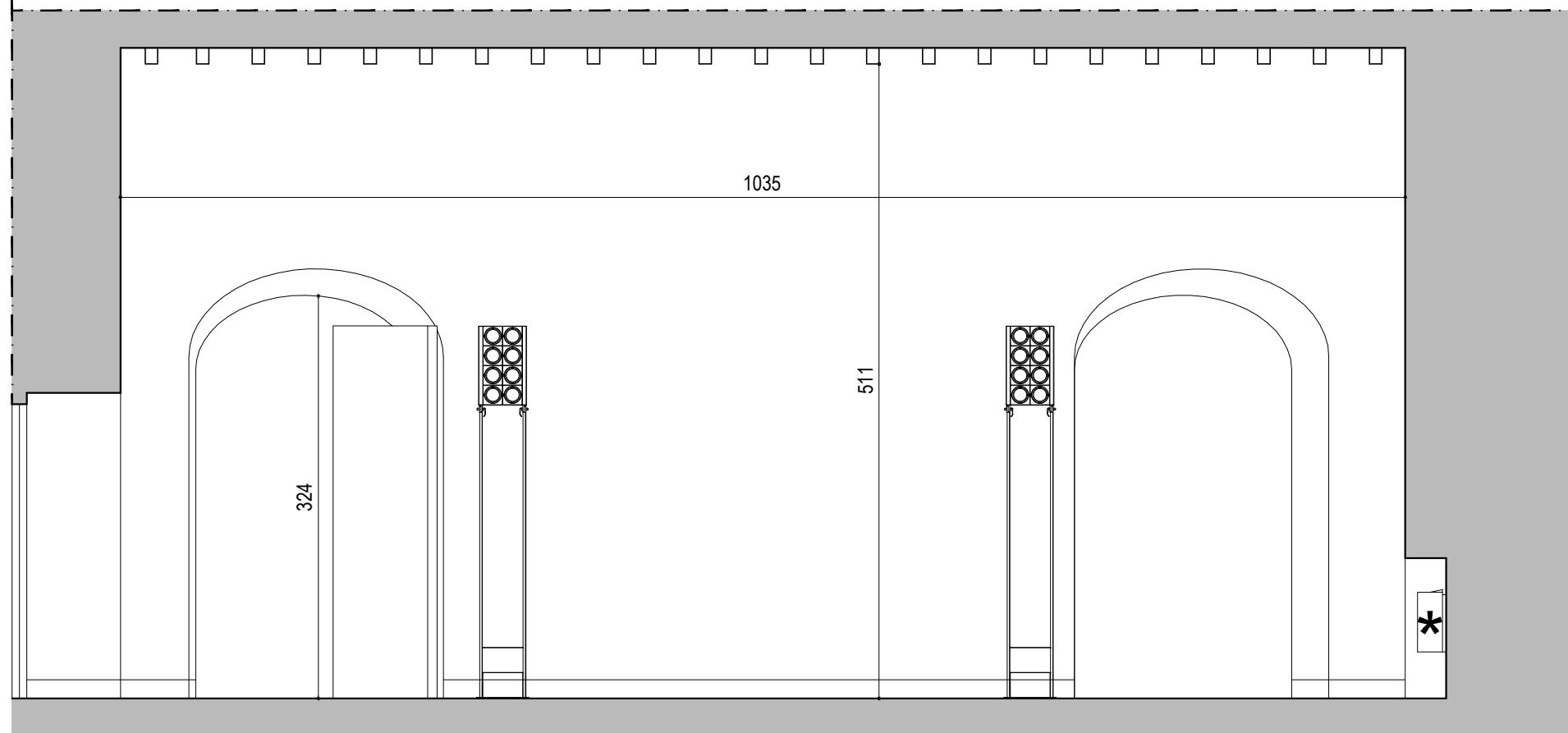

SALA 00 - PIANO I

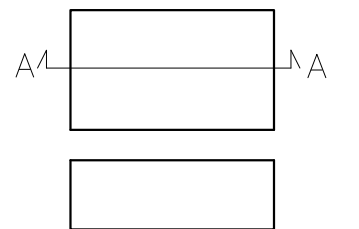
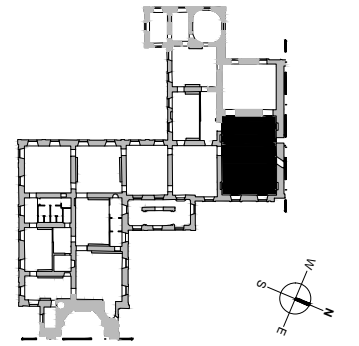

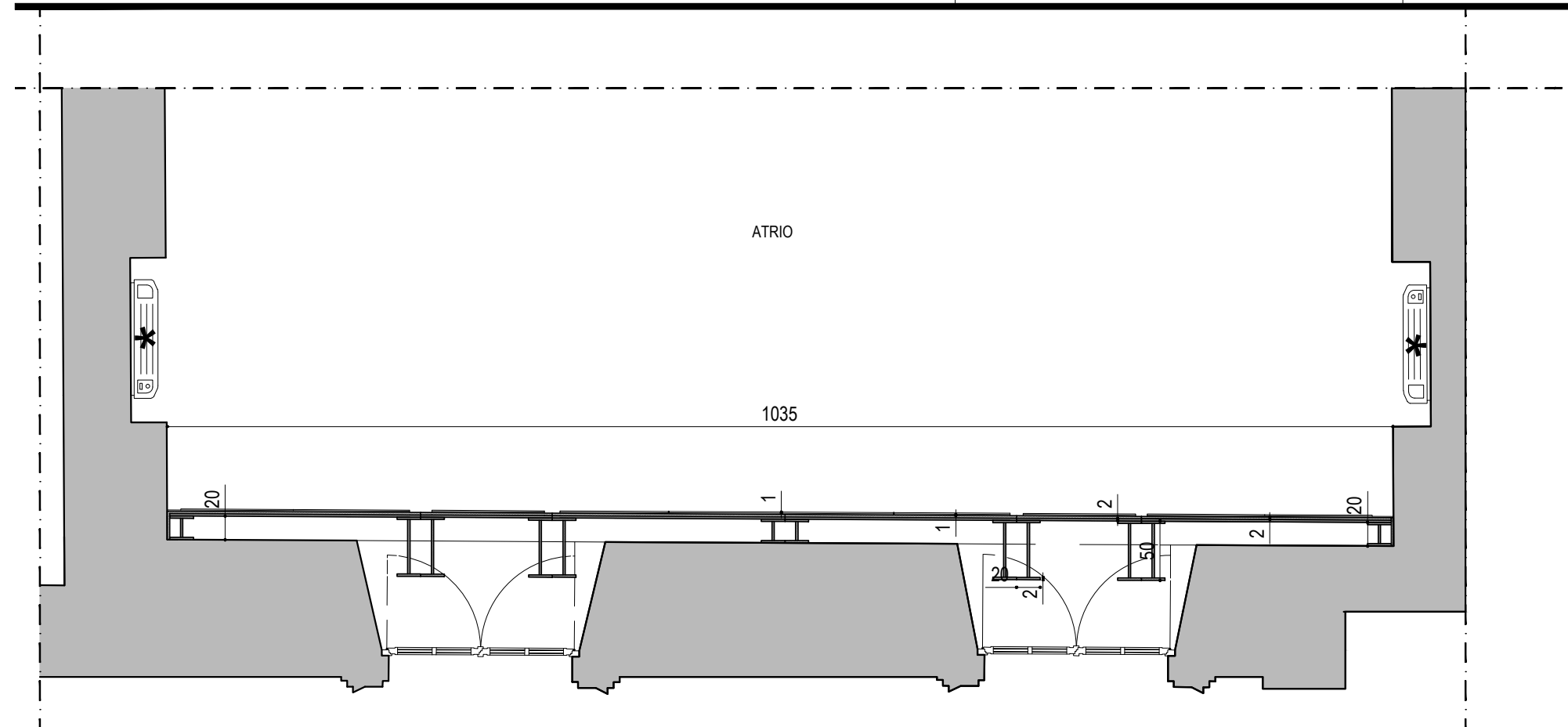

Pianta

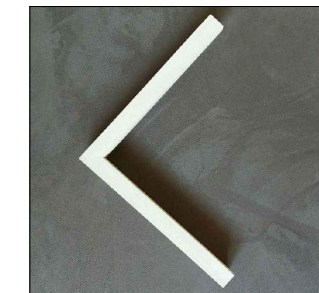

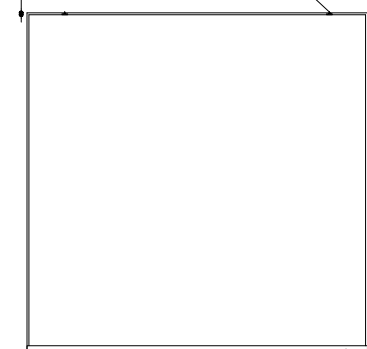

90
Triangolino in ottone

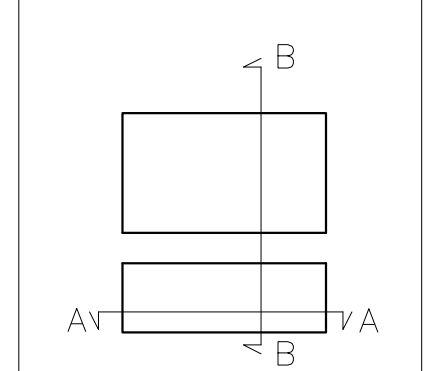
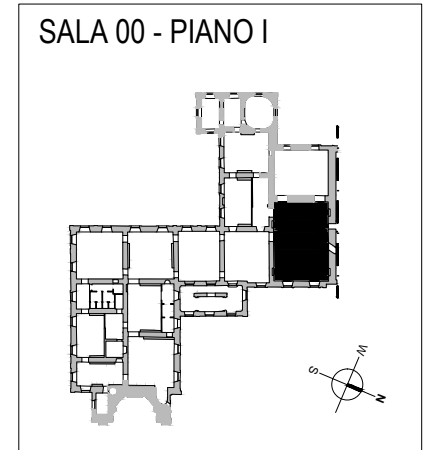

Profilo ad L 20 x15 mm a cui far aderire la base della cornice con doppio adesivo



-  MDF
-  LEGNO TAMBURATO
-  CAVALLE PER IL SOSTEGNO DELLA PARETE

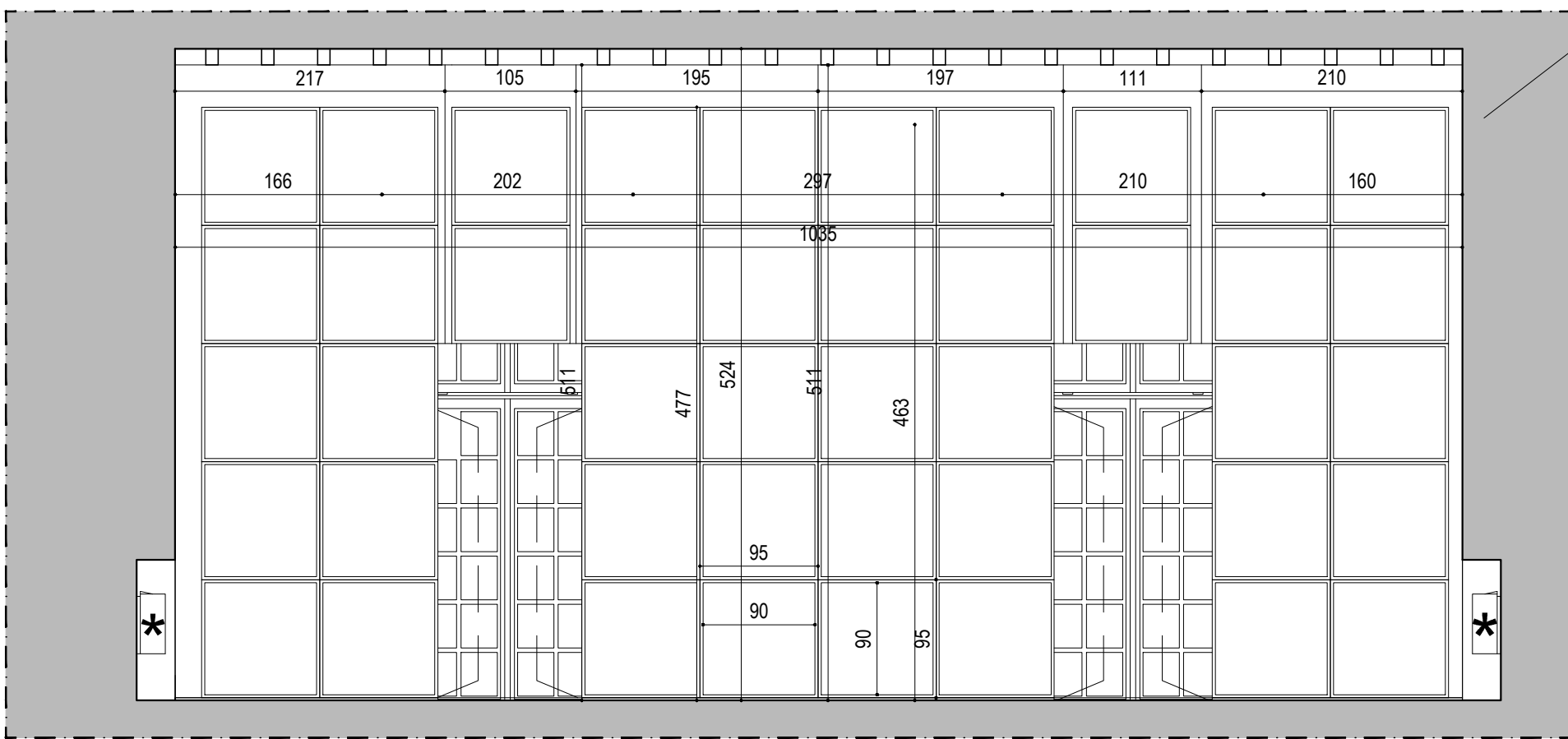

Sezione A-A'

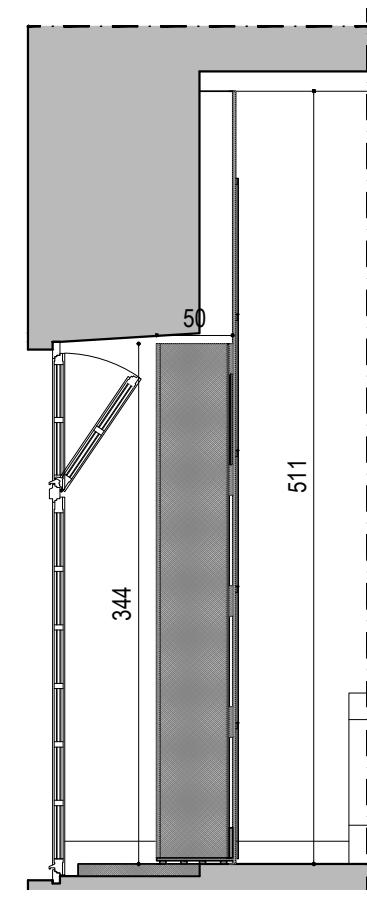

Sezione B-B'

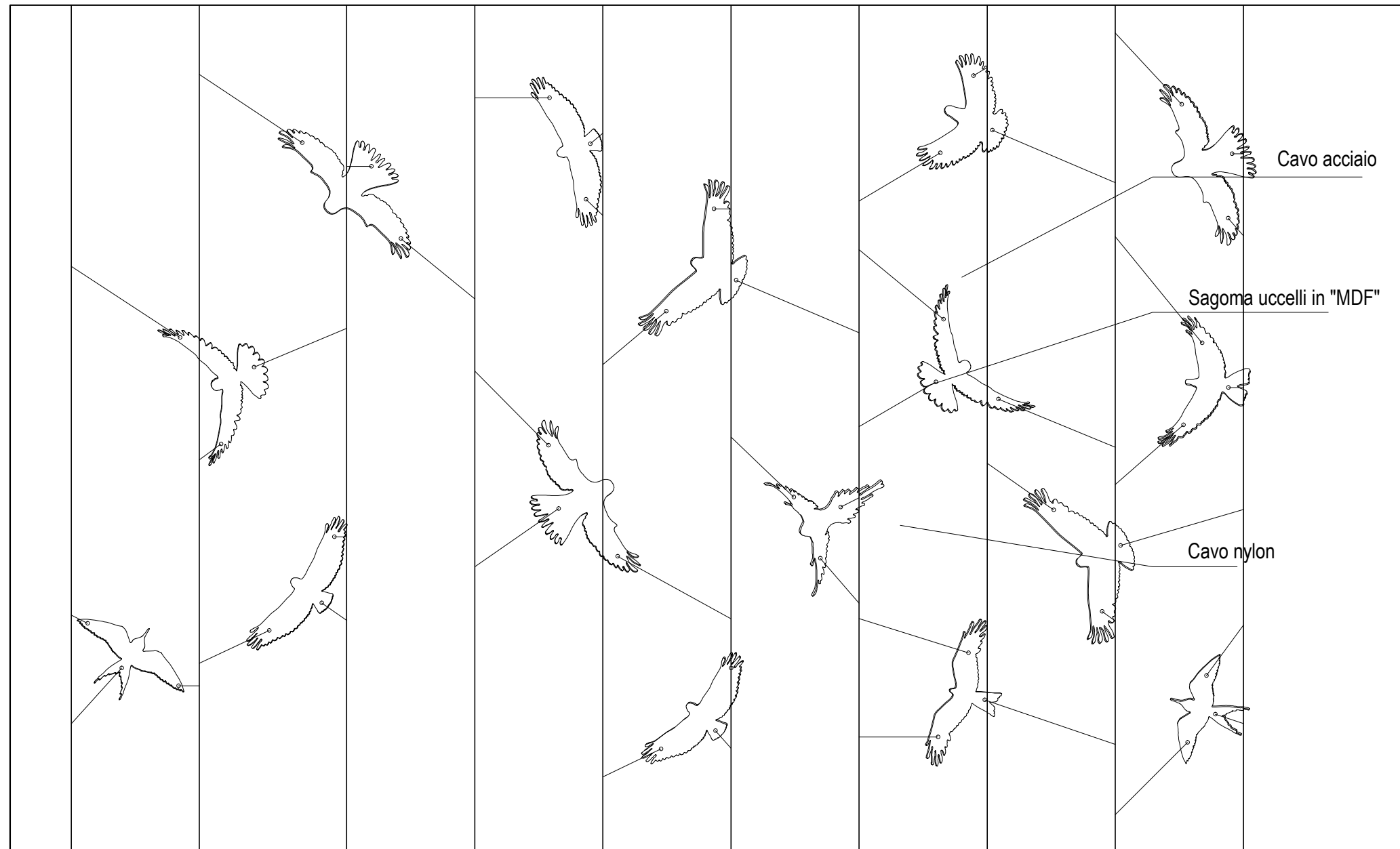

SALA 04 - PIANO I

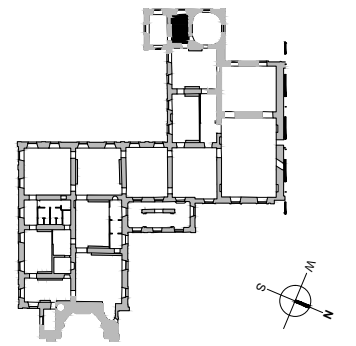

SALA 05 - PIANO I

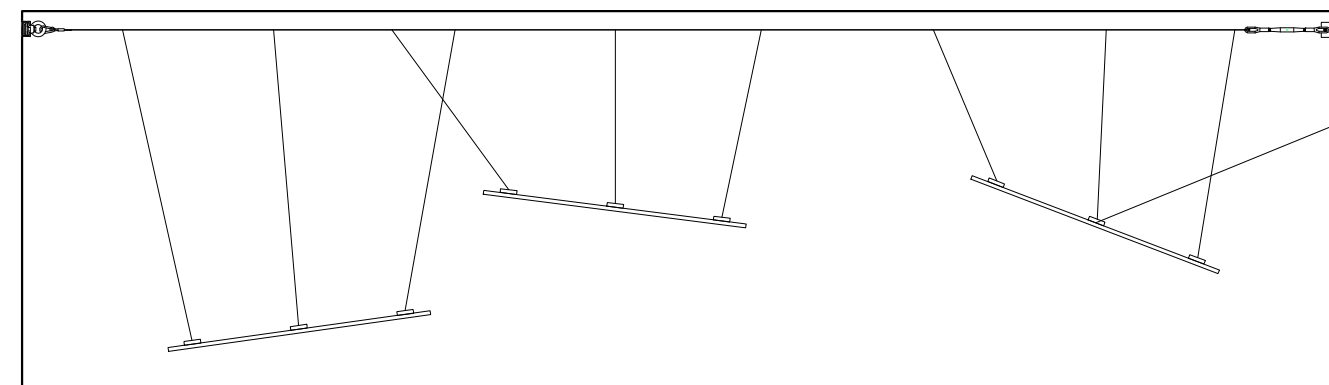
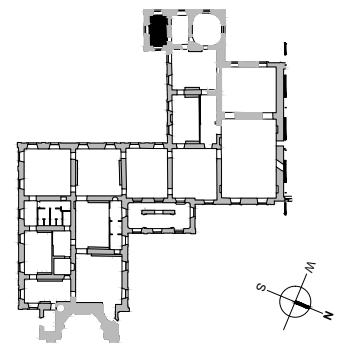

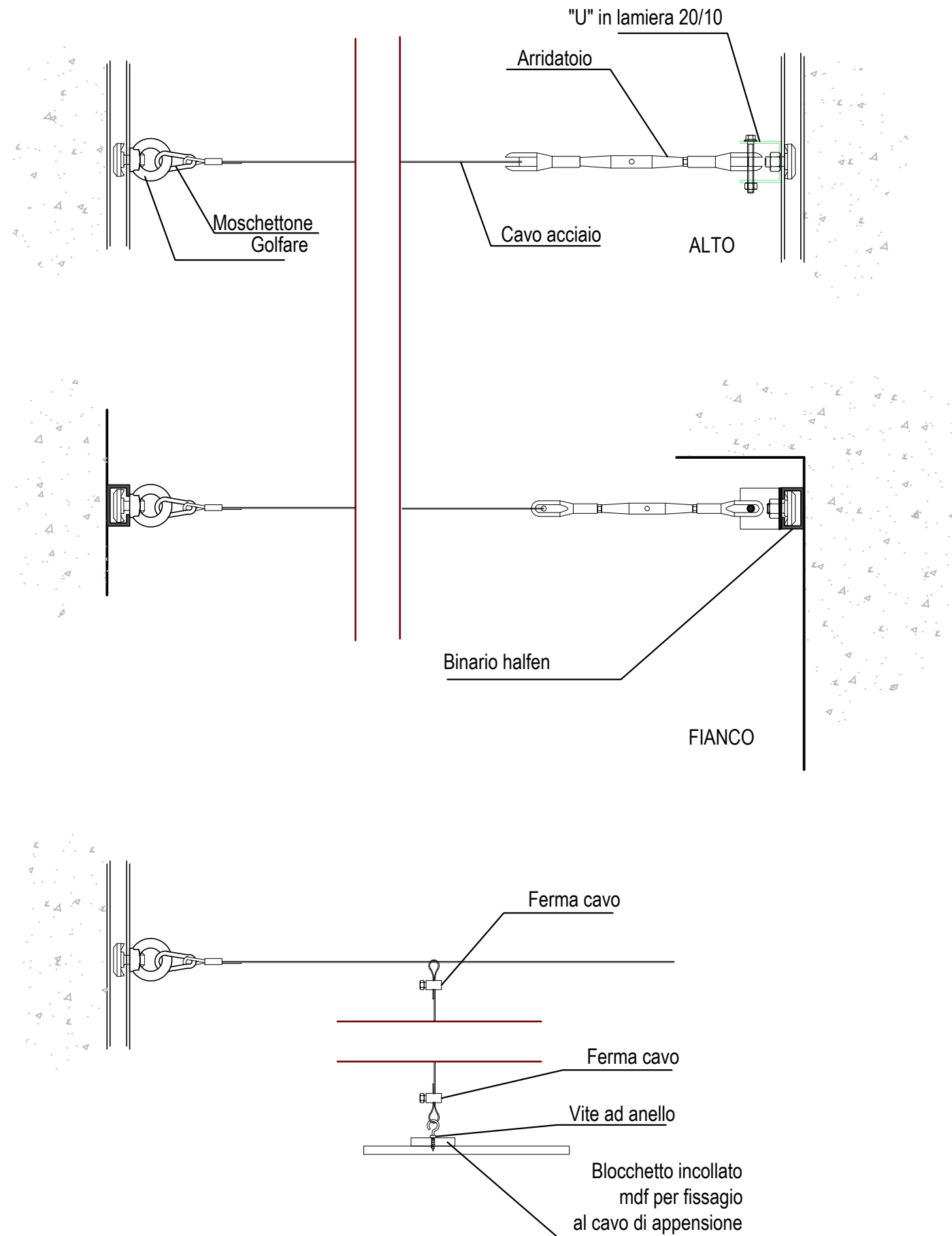

SALA 04 - PIANO I

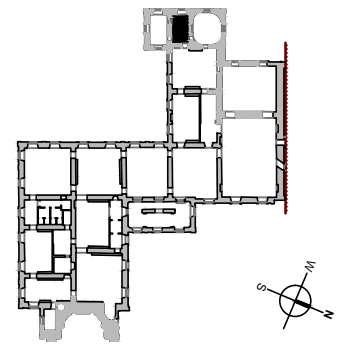

SALA 05 - PIANO I

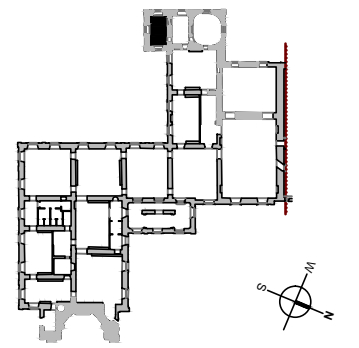

Esempio di posizionamento tipo

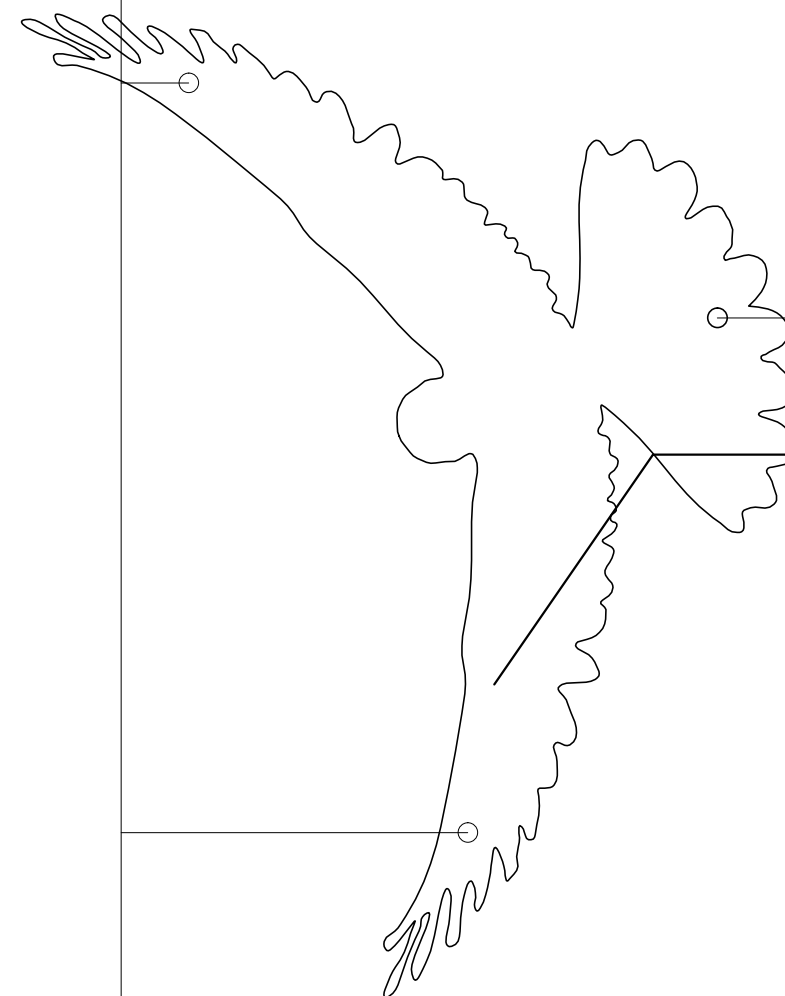

SALA 06 - PIANO I

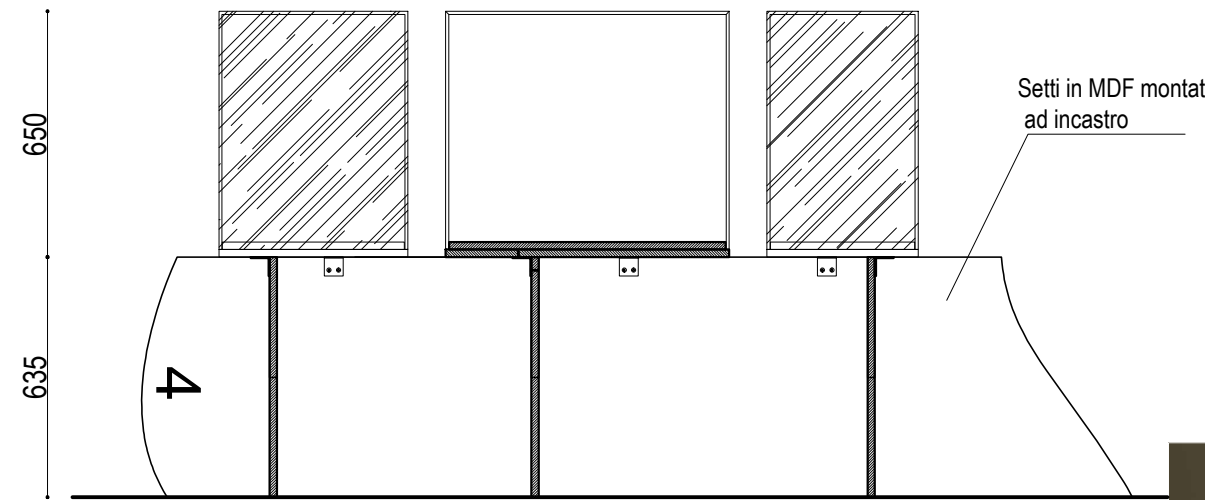
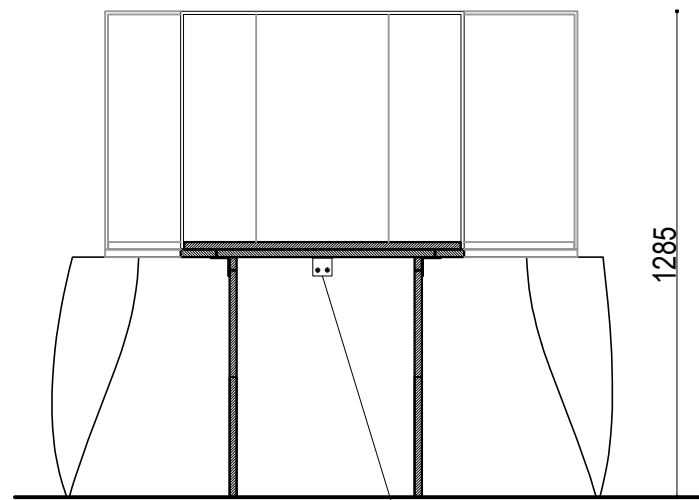
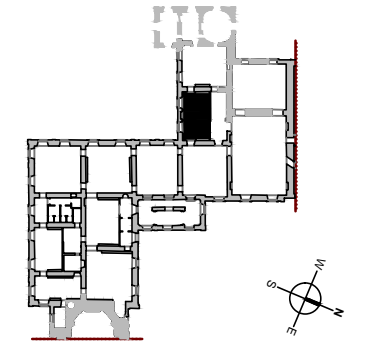

Fissaggio teche con piastre ad "L"

1480

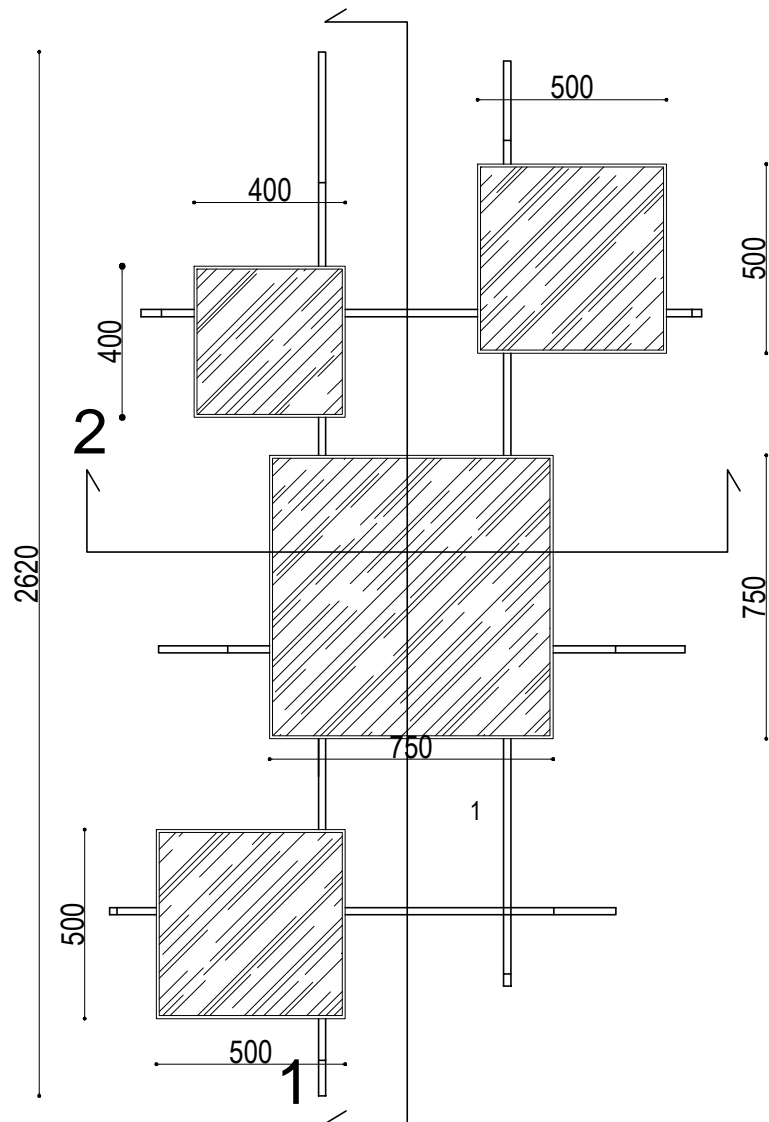

Teca in plexiglass sp. 8 mm

Piano vetrina in MDF

Staffa di fissaggio

Base vetrine in MDF grezzo

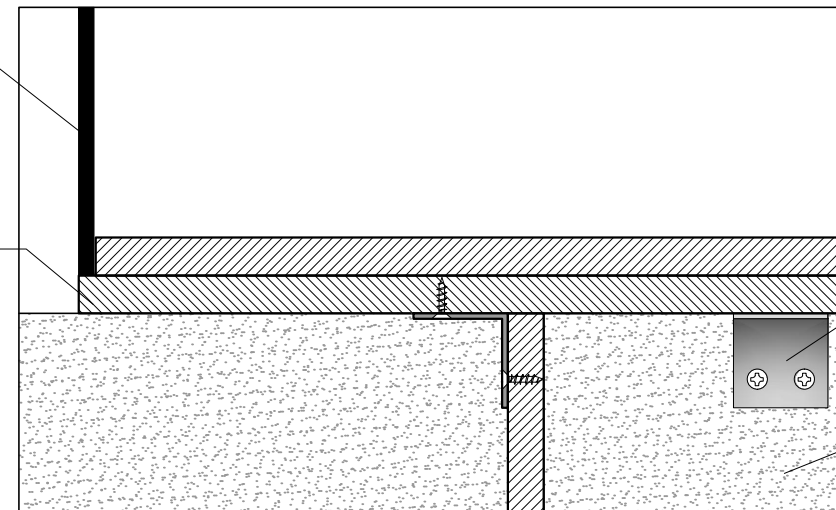

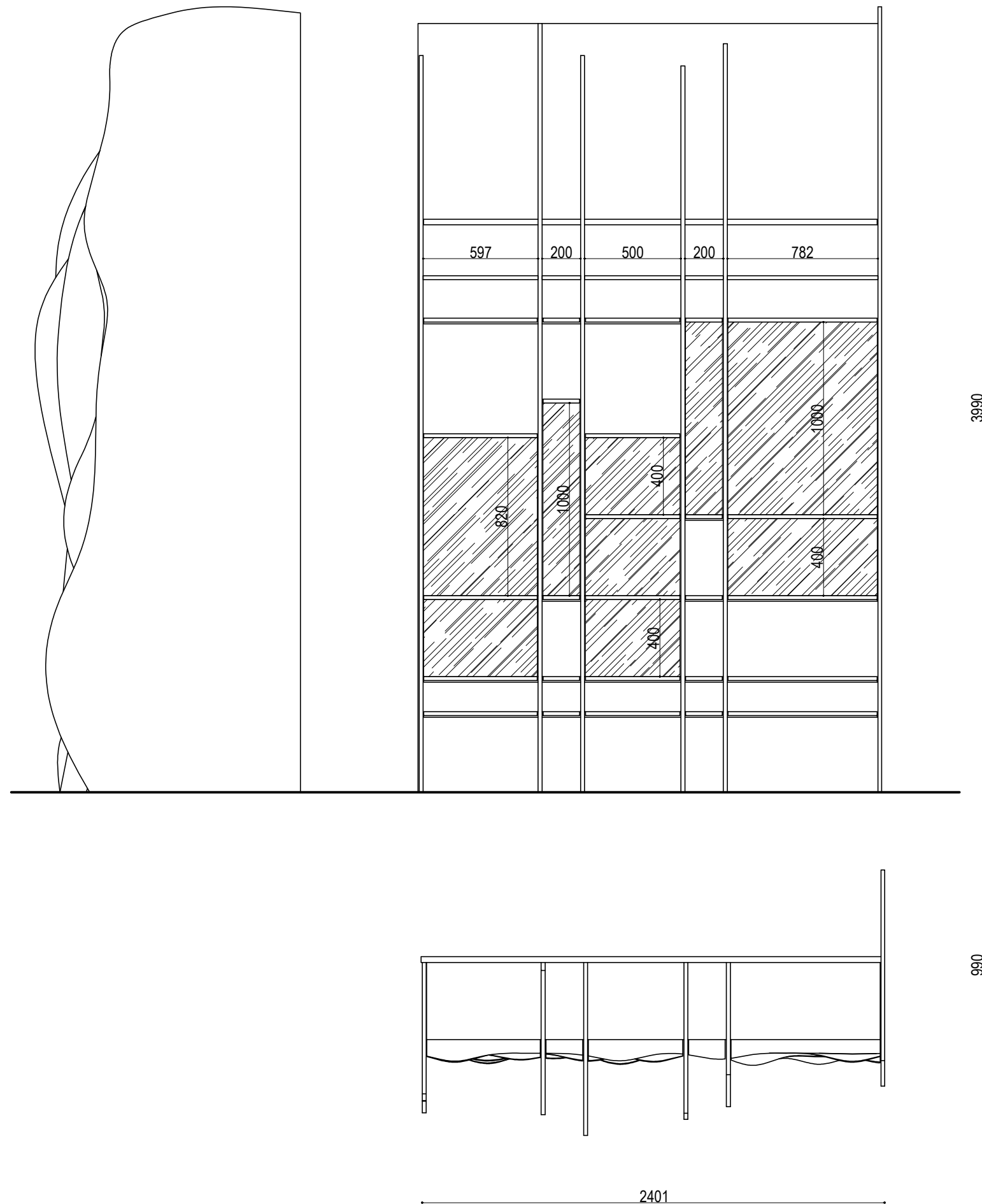

SALA 06 - PIANO I

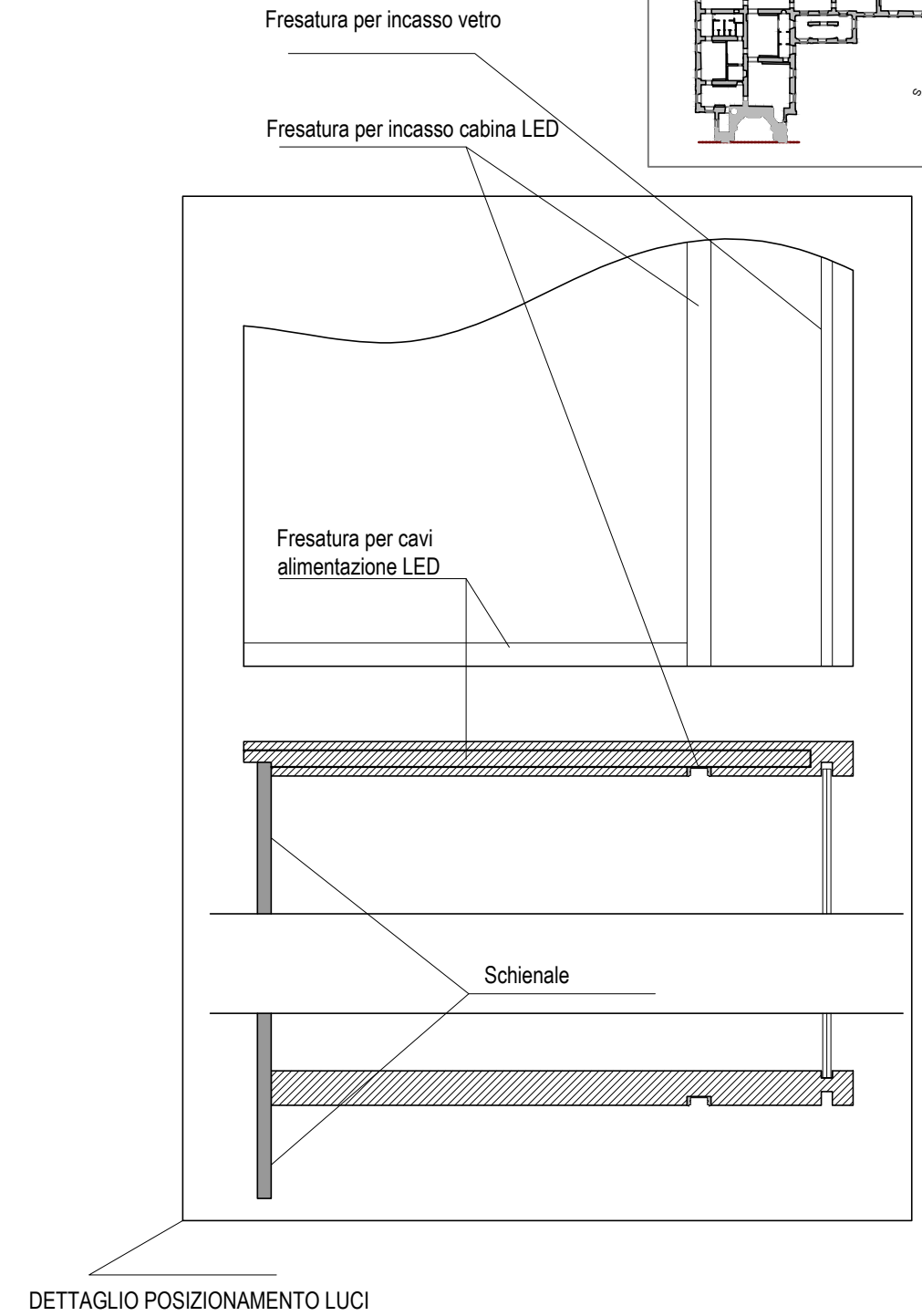
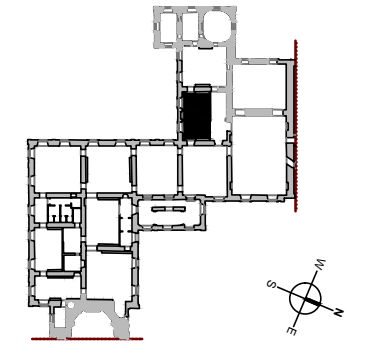

SALA 00 - PIANO I

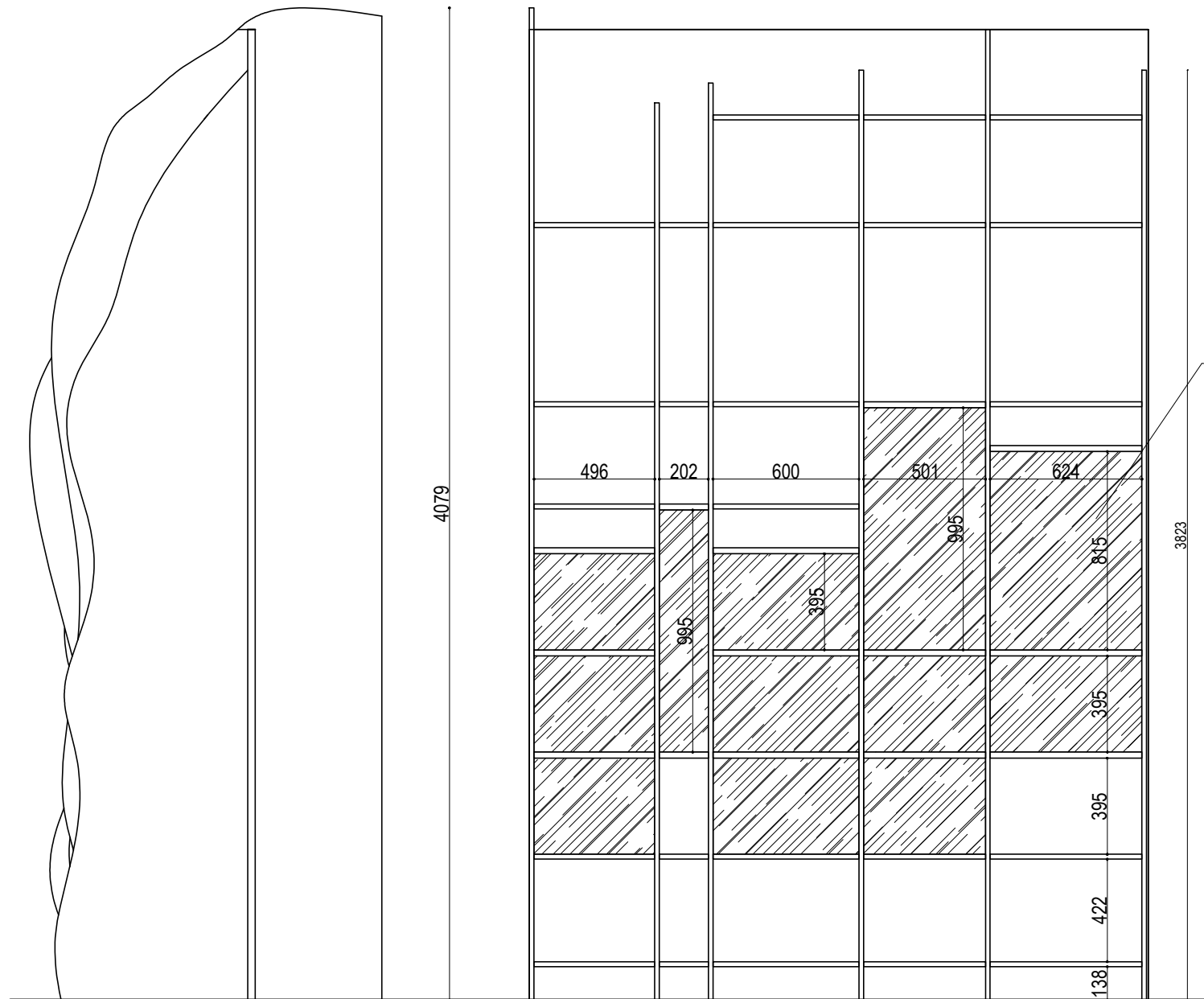
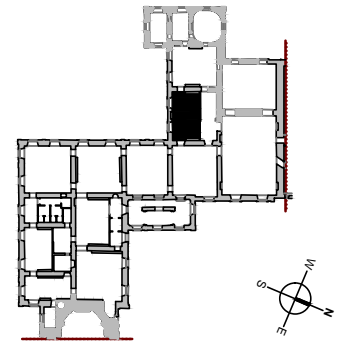

Interno vetrina



Fondale avanzato

Sagoma in plexiglass sp. 5mm

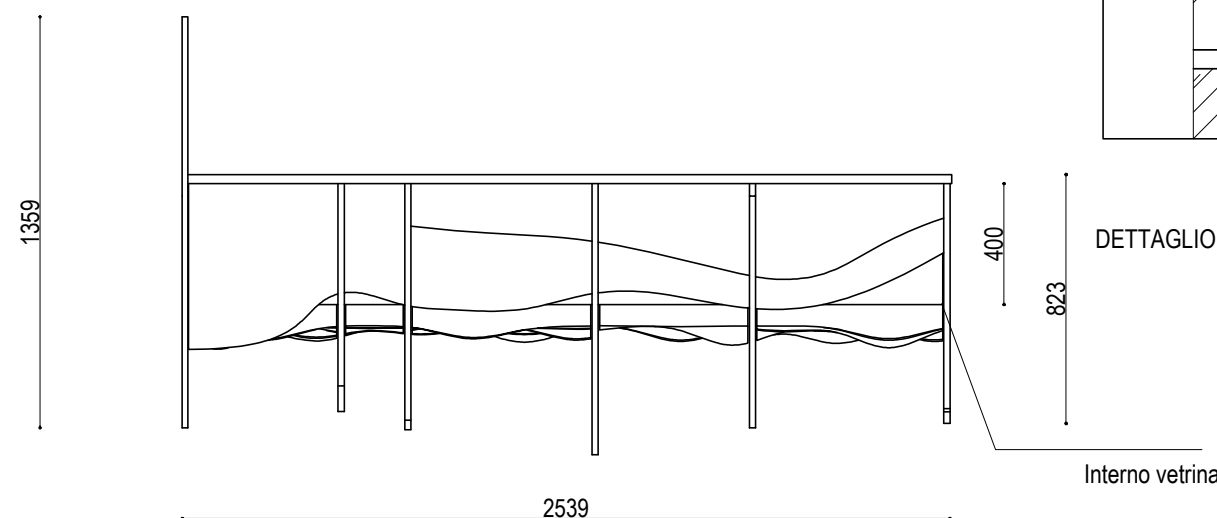
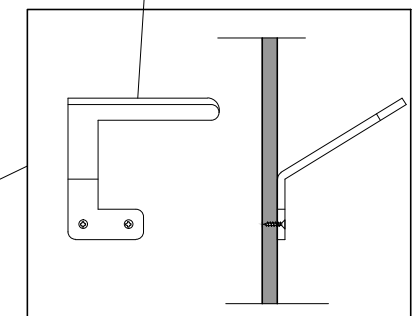

DETTAGLIO APPENDIMENTO CRAVATTA-Scala 1:10

Interno vetrina

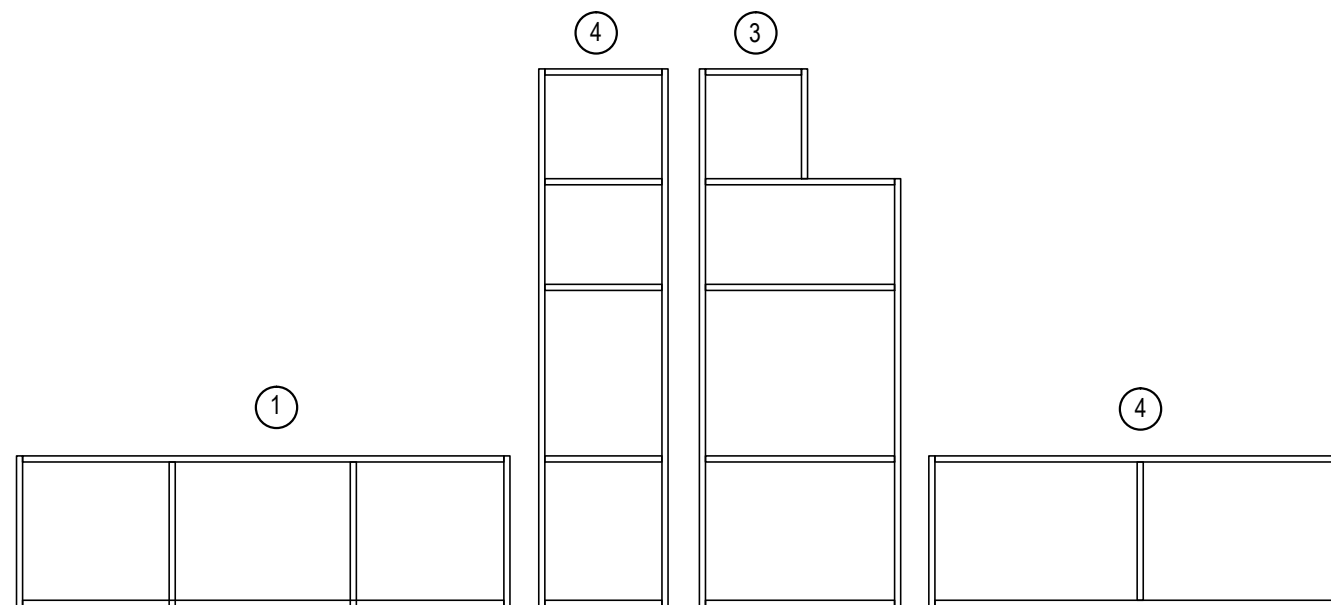
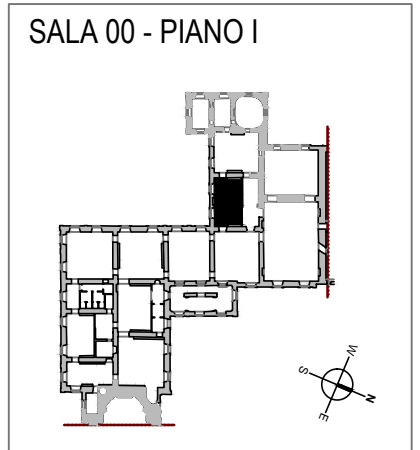
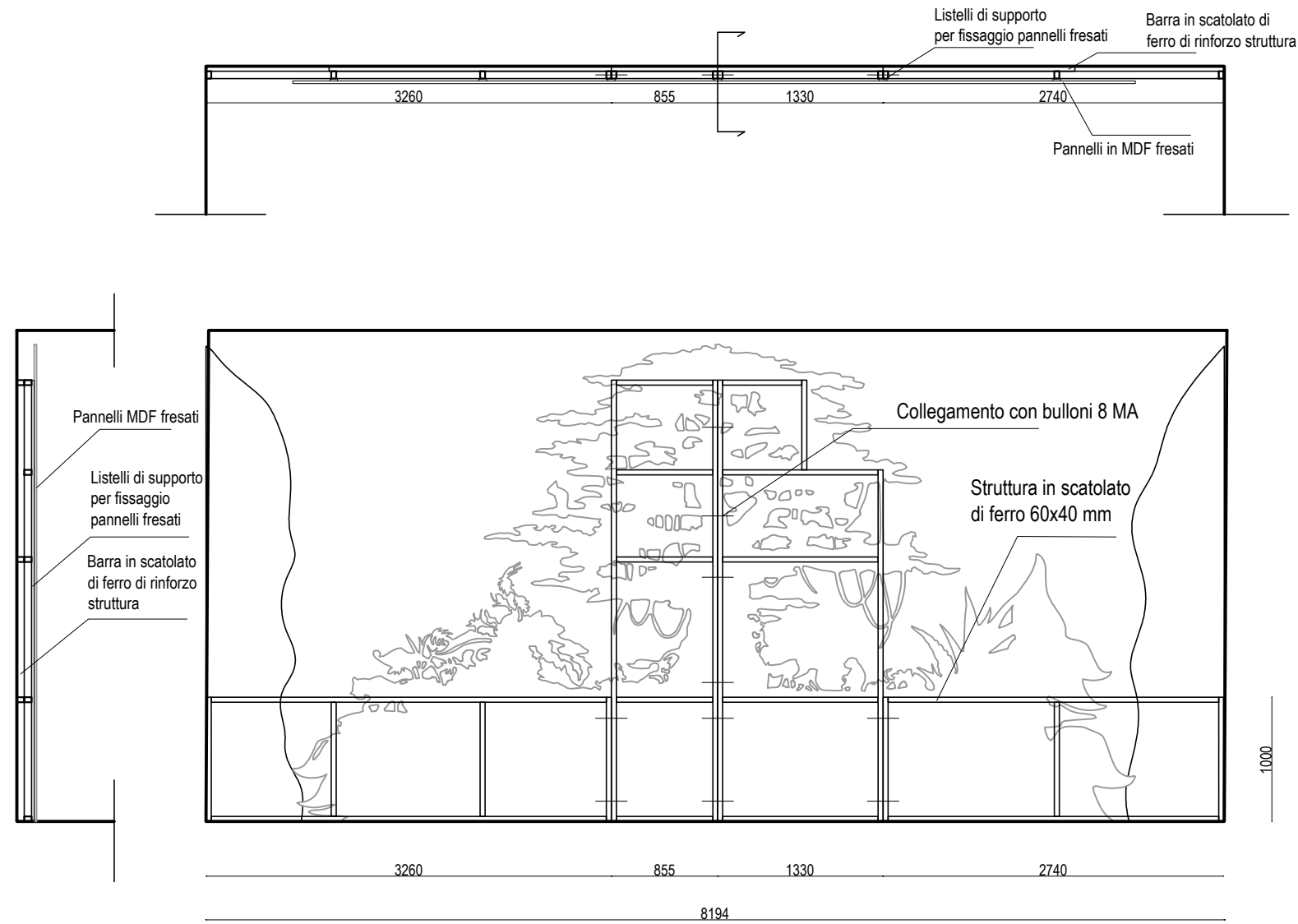

SCHEMA STRUTTURALE METALLICHE

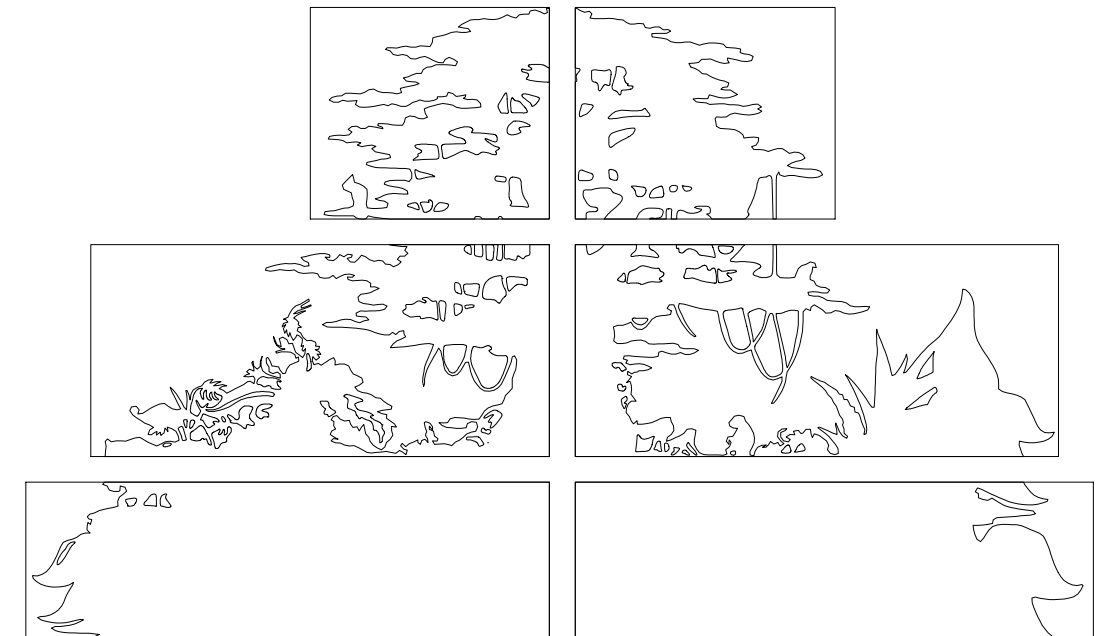

SCOMPOSIZIONE IN PANNELLI DA FRESARE

